

# FLIGHT TRAINING

## FLIGHT OPERATIONS MANUAL



# Flight Operations Manual

Company Pilot Edition

Cirrus Perspective Avionics

SR20, SR22, SR22T



## NOTE

Procedures in this publication are derived from procedures in the following FAA Approved Airplane Flight Manuals (AFM):

- SR20, P/N 11934-004, Reissue A,
- SR22, P/N 13772-004, Original Release,
- SR22T, P/N 13772-005, Original Release.

Cirrus Aircraft has attempted to ensure that the data contained agrees with the data in the respective AFM. If there is any disagreement, ***the Airplane Flight Manual is the final authority.***

# List of Effective Pages

Use this page to determine the current effective date for each page in the FOM.

Original Issue..... Feb 2013

| Page   | Status   | Page | Status   | Page | Status   |
|--------|----------|------|----------|------|----------|
| LOEP-1 | Feb 2013 | 2-17 | Feb 2013 | 3-23 | Feb 2013 |
| LOEP-2 | Feb 2013 | 2-18 | Feb 2013 | 3-24 | Feb 2013 |
| TOC-1  | Feb 2013 | 2-19 | Feb 2013 | 3-25 | Feb 2013 |
| TOC-2  | Feb 2013 | 2-20 | Feb 2013 | 3-26 | Feb 2013 |
| TOC-3  | Feb 2013 | 2-21 | Feb 2013 | 3-27 | Feb 2013 |
| TOC-4  | Feb 2013 | 2-22 | Feb 2013 | 3-28 | Feb 2013 |
| 1-1    | Feb 2013 | 2-23 | Feb 2013 | 3-29 | Feb 2013 |
| 1-2    | Feb 2013 | 2-24 | Feb 2013 | 3-30 | Feb 2013 |
| 1-3    | Feb 2013 | 2-25 | Feb 2013 | 3-31 | Feb 2013 |
| 1-4    | Feb 2013 | 2-26 | Feb 2013 | 3-32 | Feb 2013 |
| 1-5    | Feb 2013 | 2-27 | Feb 2013 | 3-33 | Feb 2013 |
| 1-6    | Feb 2013 | 2-28 | Feb 2013 | 3-34 | Feb 2013 |
| 1-7    | Feb 2013 | 2-29 | Feb 2013 | 3-35 | Feb 2013 |
| 1-8    | Feb 2013 | 2-30 | Feb 2013 | 3-36 | Feb 2013 |
| 1-9    | Feb 2013 | 2-31 | Feb 2013 | 3-37 | Feb 2013 |
| 1-10   | Feb 2013 | 2-32 | Feb 2013 | 3-38 | Feb 2013 |
| 1-11   | Feb 2013 | 2-33 | Feb 2013 | 3-39 | Feb 2013 |
| 1-12   | Feb 2013 | 2-34 | Feb 2013 | 3-40 | Feb 2013 |
| 1-13   | Feb 2013 | 2-35 | Feb 2013 | 3-41 | Feb 2013 |
| 1-14   | Feb 2013 | 2-36 | Feb 2013 | 3-42 | Feb 2013 |
| 1-15   | Feb 2013 | 2-37 | Feb 2013 | 3-43 | Feb 2013 |
| 1-16   | Feb 2013 | 2-38 | Feb 2013 | 3-44 | Feb 2013 |
| 1-17   | Feb 2013 | 2-39 | Feb 2013 | 3-45 | Feb 2013 |
| 1-18   | Feb 2013 | 2-40 | Feb 2013 | 3-46 | Feb 2013 |
| 1-19   | Feb 2013 | 3-1  | Feb 2013 | 3-47 | Feb 2013 |
| 1-20   | Feb 2013 | 3-2  | Feb 2013 | 3-48 | Feb 2013 |
| 1-21   | Feb 2013 | 3-3  | Feb 2013 | 3-49 | Feb 2013 |
| 1-22   | Feb 2013 | 3-4  | Feb 2013 | 3-50 | Feb 2013 |
| 1-23   | Feb 2013 | 3-5  | Feb 2013 | 3-51 | Feb 2013 |
| 1-24   | Feb 2013 | 3-6  | Feb 2013 | 3-52 | Feb 2013 |
| 2-1    | Feb 2013 | 3-7  | Feb 2013 | 3-53 | Feb 2013 |
| 2-2    | Feb 2013 | 3-8  | Feb 2013 | 3-54 | Feb 2013 |
| 2-3    | Feb 2013 | 3-9  | Feb 2013 | 3-55 | Feb 2013 |
| 2-4    | Feb 2013 | 3-10 | Feb 2013 | 3-56 | Feb 2013 |
| 2-5    | Feb 2013 | 3-11 | Feb 2013 | 3-57 | Feb 2013 |
| 2-6    | Feb 2013 | 3-12 | Feb 2013 | 3-58 | Feb 2013 |
| 2-7    | Feb 2013 | 3-13 | Feb 2013 | 3-59 | Feb 2013 |
| 2-8    | Feb 2013 | 3-14 | Feb 2013 | 3-60 | Feb 2013 |
| 2-9    | Feb 2013 | 3-15 | Feb 2013 | 3-61 | Feb 2013 |
| 2-10   | Feb 2013 | 3-16 | Feb 2013 | 3-62 | Feb 2013 |
| 2-11   | Feb 2013 | 3-17 | Feb 2013 | 3-63 | Feb 2013 |
| 2-12   | Feb 2013 | 3-18 | Feb 2013 | 3-64 | Feb 2013 |
| 2-13   | Feb 2013 | 3-19 | Feb 2013 | 3-65 | Feb 2013 |
| 2-14   | Feb 2013 | 3-20 | Feb 2013 | 3-66 | Feb 2013 |
| 2-15   | Feb 2013 | 3-21 | Feb 2013 | 3-67 | Feb 2013 |
| 2-16   | Feb 2013 | 3-22 | Feb 2013 | 3-68 | Feb 2013 |

## List of Effective Pages (Cont.)

| Page | Status   | Page | Status   | Page | Status   |
|------|----------|------|----------|------|----------|
| 3-69 | Feb 2013 | 4-28 | Feb 2013 | 5-27 | Feb 2013 |
| 3-70 | Feb 2013 | 4-29 | Feb 2013 | 5-28 | Feb 2013 |
| 3-71 | Feb 2013 | 4-30 | Feb 2013 | 5-29 | Feb 2013 |
| 3-72 | Feb 2013 | 4-31 | Feb 2013 | 5-30 | Feb 2013 |
| 3-73 | Feb 2013 | 4-32 | Feb 2013 | 5-31 | Feb 2013 |
| 3-74 | Feb 2013 | 4-33 | Feb 2013 | 5-32 | Feb 2013 |
| 3-75 | Feb 2013 | 4-34 | Feb 2013 | 6-1  | Feb 2013 |
| 3-76 | Feb 2013 | 4-35 | Feb 2013 | 6-2  | Feb 2013 |
| 3-77 | Feb 2013 | 4-36 | Feb 2013 | 7-1  | Feb 2013 |
| 3-78 | Feb 2013 | 4-37 | Feb 2013 | 7-2  | Feb 2013 |
| 3-79 | Feb 2013 | 4-38 | Feb 2013 |      |          |
| 3-80 | Feb 2013 | 4-39 | Feb 2013 |      |          |
| 3-81 | Feb 2013 | 4-40 | Feb 2013 |      |          |
| 3-82 | Feb 2013 | 4-41 | Feb 2013 |      |          |
| 3-83 | Feb 2013 | 4-42 | Feb 2013 |      |          |
| 3-84 | Feb 2013 | 4-43 | Feb 2013 |      |          |
| 3-85 | Feb 2013 | 4-44 | Feb 2013 |      |          |
| 3-86 | Feb 2013 | 4-45 | Feb 2013 |      |          |
| 3-87 | Feb 2013 | 4-46 | Feb 2013 |      |          |
| 3-88 | Feb 2013 | 4-47 | Feb 2013 |      |          |
| 3-89 | Feb 2013 | 4-48 | Feb 2013 |      |          |
| 3-90 | Feb 2013 | 4-49 | Feb 2013 |      |          |
| 3-91 | Feb 2013 | 4-50 | Feb 2013 |      |          |
| 3-92 | Feb 2013 | 4-51 | Feb 2013 |      |          |
| 3-93 | Feb 2013 | 4-52 | Feb 2013 |      |          |
| 3-94 | Feb 2013 | 4-53 | Feb 2013 |      |          |
| 4-1  | Feb 2013 | 4-54 | Feb 2013 |      |          |
| 4-2  | Feb 2013 | 5-1  | Feb 2013 |      |          |
| 4-3  | Feb 2013 | 5-2  | Feb 2013 |      |          |
| 4-4  | Feb 2013 | 5-3  | Feb 2013 |      |          |
| 4-5  | Feb 2013 | 5-4  | Feb 2013 |      |          |
| 4-6  | Feb 2013 | 5-5  | Feb 2013 |      |          |
| 4-7  | Feb 2013 | 5-6  | Feb 2013 |      |          |
| 4-8  | Feb 2013 | 5-7  | Feb 2013 |      |          |
| 4-9  | Feb 2013 | 5-8  | Feb 2013 |      |          |
| 4-10 | Feb 2013 | 5-9  | Feb 2013 |      |          |
| 4-11 | Feb 2013 | 5-10 | Feb 2013 |      |          |
| 4-12 | Feb 2013 | 5-11 | Feb 2013 |      |          |
| 4-13 | Feb 2013 | 5-12 | Feb 2013 |      |          |
| 4-14 | Feb 2013 | 5-13 | Feb 2013 |      |          |
| 4-15 | Feb 2013 | 5-14 | Feb 2013 |      |          |
| 4-16 | Feb 2013 | 5-15 | Feb 2013 |      |          |
| 4-17 | Feb 2013 | 5-16 | Feb 2013 |      |          |
| 4-18 | Feb 2013 | 5-17 | Feb 2013 |      |          |
| 4-19 | Feb 2013 | 5-18 | Feb 2013 |      |          |
| 4-20 | Feb 2013 | 5-19 | Feb 2013 |      |          |
| 4-21 | Feb 2013 | 5-20 | Feb 2013 |      |          |
| 4-22 | Feb 2013 | 5-21 | Feb 2013 |      |          |
| 4-23 | Feb 2013 | 5-22 | Feb 2013 |      |          |
| 4-24 | Feb 2013 | 5-23 | Feb 2013 |      |          |
| 4-25 | Feb 2013 | 5-24 | Feb 2013 |      |          |
| 4-26 | Feb 2013 | 5-25 | Feb 2013 |      |          |
| 4-27 | Feb 2013 | 5-26 | Feb 2013 |      |          |

# Table of Contents

## Section 1

**Introduction ..... 1-1**  
General ..... 1-1  
Reference Materials ..... 1-2  
Terms and Abbreviations ..... 1-3  
Contact Information ..... 1-5

## Section 2

**General Operating Procedures ..... 2-1**  
General ..... 2-1  
Pilot Qualification and Training ..... 2-2  
Pilot Weather Minimums ..... 2-8  
Pilot Duty and Rest Period ..... 2-13  
Aircraft Maintenance and Airworthiness ..... 2-16  
Flight Planning ..... 2-19  
Flight Considerations ..... 2-25  
Flight Safety ..... 2-28  
Flying Club Procedures ..... 2-30  
International Border Operations ..... 2-35  
Incident and Accident Procedures (U.S. Only) ..... 2-37  
Aircraft Incident and Accident Report ..... 2-38

## Section 3

**Standard Operating Procedures ..... 3-1**  
General ..... 3-1  
Single Pilot Resource Management ..... 3-2  
Checklist Philosophy ..... 3-5  
Pre-Flight Inspection ..... 3-7  
Before Engine Start ..... 3-21  
Engine Start ..... 3-23  
Before Taxi ..... 3-27  
Taxi-Out ..... 3-29  
Before Takeoff ..... 3-32  
Takeoff Briefing ..... 3-37  
Normal Takeoff ..... 3-38  
Short-Field Takeoff ..... 3-42  
Soft-Field Takeoff ..... 3-45

# Table of Contents

|  |      |
|--|------|
| Crosswind Takeoff Technique.....         | 3-46 |
| Enroute Climb .....                      | 3-47 |
| Cruise.....                              | 3-52 |
| Icing Conditions (FIKI).....             | 3-54 |
| Descent.....                             | 3-57 |
| Before Landing and Traffic Pattern ..... | 3-60 |
| Stabilized Approach Definition .....     | 3-64 |
| Instrument Approach Procedures .....     | 3-66 |
| Precision Approach Procedure .....       | 3-68 |
| Nonprecision Approach Procedure .....    | 3-73 |
| Go-Around.....                           | 3-78 |
| Approach and Landing Speeds.....         | 3-81 |
| Normal Landing.....                      | 3-82 |
| Short-Field Landing.....                 | 3-84 |
| Soft-Field Landing .....                 | 3-85 |
| Crosswind Landing.....                   | 3-86 |
| Reduced Flap Landings (0% and 50%) ..... | 3-87 |
| Icing Landing Procedure .....            | 3-88 |
| After Landing.....                       | 3-90 |
| Arrival and Engine Shutdown.....         | 3-92 |

## Section 4

|   |            |
|---|------------|
| <b>Emergency &amp; Abnormal Procedures.....</b> | <b>4-1</b> |
| General .....                                   | 4-1        |
| Checklist Usage for Abnormal Procedures .....   | 4-1        |
| Checklist Usage for Emergency Procedures .....  | 4-1        |
| CAPS Deployment .....                           | 4-2        |
| Emergency Descent.....                          | 4-7        |
| Engine Malfunctions Overview.....               | 4-9        |
| Engine Failure In Flight.....                   | 4-10       |
| Emergency Landing Without Engine Power.....     | 4-14       |
| Unexplained Loss of Manifold Pressure.....      | 4-17       |
| Engine Roughness or Partial Power Loss.....     | 4-20       |
| Loss of Oil Pressure.....                       | 4-22       |
| Engine Fire In Flight.....                      | 4-24       |
| Electrical Malfunctions Overview .....          | 4-27       |
| Alternator 1 and 2 Failures.....                | 4-28       |

# Table of Contents

|   |      |
|---|------|
| Electrical Fire (Cabin Fire In Flight).....     | 4-30 |
| Integrated Avionics Malfunctions Overview ..... | 4-32 |
| PFD Display Failure and Reversionary Mode ..... | 4-34 |
| Air Data Computer Failure .....                 | 4-36 |
| AHRS Failure .....                              | 4-38 |
| GIA Failure .....                               | 4-40 |
| Loss of GPS Integrity .....                     | 4-41 |
| Other Emergency Procedures Overview .....       | 4-42 |
| Unusual Attitudes .....                         | 4-42 |
| Inadvertent Flight into IMC .....               | 4-44 |
| Flap Malfunction.....                           | 4-46 |
| Oxygen System Malfunction .....                 | 4-47 |
| Power Lever Linkage Failure .....               | 4-49 |
| Loss of Brake Pressure.....                     | 4-51 |
| Open Door .....                                 | 4-53 |

## Section 5

|   |            |
|---|------------|
| <b>Maneuvers.....</b>                     | <b>5-1</b> |
| General .....                             | 5-1        |
| Steep Turns (Private and Commercial)..... | 5-2        |
| Steep Spirals (Commercial) .....          | 5-4        |
| Chandelle (Commercial) .....              | 5-7        |
| Lazy Eights (Commercial) .....            | 5-10       |
| Maneuvering during Slow Flight.....       | 5-14       |
| Power-Off Stalls .....                    | 5-16       |
| Power-On Stalls .....                     | 5-18       |
| Autopilot Stall Recognition .....         | 5-20       |
| Ground Reference Maneuvers.....           | 5-22       |
| Rectangular Course (Private) .....        | 5-23       |
| S-Turns (Private).....                    | 5-25       |
| Turns Around a Point (Private) .....      | 5-27       |
| Eight On Pylons (Commercial).....         | 5-29       |

## Section 6

|                          |            |
|--------------------------|------------|
| <b>Performance .....</b> | <b>6-1</b> |
| General .....            | 6-1        |

## Section 7

# Table of Contents

**Limitations .....7-1**  
General .....7-1



# Section 1

## Introduction

### General

The procedures in this publication are derived from procedures in the FAA Approved Airplane Flight Manual (AFM). Cirrus Aircraft has attempted to ensure that the data contained herein agrees with the data in the AFM. If there is any disagreement, ***the Airplane Flight Manual is the final authority.***

The Flight Operations Manual (FOM), Company Pilot Edition describes the policies and procedures for all flight conducted in aircraft that are owned or operated by Cirrus Aircraft. Section 2 of this document describes general operating procedures and training requirements. Sections 3, 4, and 5 describe best practices for operating Cirrus aircraft under visual or instrument flight regulations for standard or typical circumstances considering normal and abnormal/emergency situations.

### Pilot Responsibilities

Cirrus pilots conducting flights in Cirrus owned or operated aircraft must adhere to the guidance contained herein. Pilots should exercise good judgment and adapt the procedures as necessary to handle non standard or atypical situations.

Flight operations must be conducted with the utmost regard to safety, professionalism, and integrity. Negligent, careless, or reckless behavior will not be tolerated and may result in flight restrictions, loss of flight privileges, or termination.

Each company pilot who is authorized to conduct flight operations in Cirrus owned and operated aircraft will be issued a FOM, Company Pilot Edition. The pilot must have this document in his or her possession, printed or electronic version, during all flight operations in a Cirrus owned or operated aircraft.

This manual does not govern the operations conducted as Experimental Flight Test or Production Flight Test. However, experimental test pilots and production flight test pilots must adhere to the policies and procedures described herein for all flights not conducted as experimental or flight test.

## Revisions

The Director of Flight Operations is responsible to issue revisions to this manual. Proposed changes must be reviewed by the leadership of affected departments and must be approved by Cirrus Aircraft senior staff. Desired changes, additions or deletions to this document should be brought to the attention of the Director of Flight Operations. Additions or changes to this document will be distributed electronically until a significant number of changes warrants re-printing the new document. A new revision will supersede all previous revisions.

## Reference Materials

The following references supplement the content of this publication:

- Federal Aviation Regulations (FARs) or governing regulations, as applicable,
- Aeronautical Information Manual (AIM),
- FAA Approved Airplane Flight Manual (AFM) and Pilot's Operating Handbook (POH),
- FAA Handbook of Aeronautical Knowledge and Airplane Flying Handbook,
- Advisory Circulars,
- Cirrus Aircraft Envelope of Safety,
- Cirrus Syllabus Suite,
- Avionics Pilot Guides and Manuals,
- Aircraft Maintenance Manual,
- Formation Flight Manual,
- Demo Care Inspection and Maintenance Program manual,
- Check Pilot Manual.

## Terms and Abbreviations

The following terms and abbreviations will be referenced in this manual.

|      |  |
|------|--|
| AP   | Autopilot                                    |
| ATC  | Air Traffic Control                          |
| CAS  | Crew Alert System                            |
| DA   | Decision Altitude                            |
| ETA  | Estimated Time of Arrival                    |
| ETE  | Estimated Time Enroute                       |
| FAA  | Federal Aviation Administration              |
| FAF  | Final Approach Fix                           |
| FIKI | Flight Into Known Ice                        |
| FITS | FAA Industry Training Standards              |
| FMS  | Flight Management System                     |
| GPH  | Gallons Per Hour                             |
| GNS  | Global Navigation System                     |
| GS   | Glide-slope                                  |
| Hg   | Mercury                                      |
| IAF  | Initial Approach Fix                         |
| IAP  | Instrument Approach Procedure                |
| LNAV | Lateral Navigation                           |
| LPV  | Localizer Performance with Vertical Guidance |
| MAP  | Missed Approach Point                        |
| MDA  | Minimum Descent Altitude                     |
| MFD  | Multi Function Display                       |
| MP   | Manifold Pressure                            |
| NAS  | National Airspace System                     |
| NH   | No Hazard Anti-Ice System                    |
| PFD  | Primary Flight Display                       |

|             |  |
|-------------|--|
| PIC         | Pilot in Command   |
| RPM         | Revolutions Per Minute   |
| SRM         | Single Pilot Resource Management   |
| VNAV        | Vertical Navigation  |
| VTF         | Vectors to Final   |
| WAAS        | Wide Area Augmentation System  |
| SR20        | Cirrus SR20 equipped with Cirrus Perspective avionics  |
| SR22        | Cirrus SR22 with normally-aspirated engine equipped with Cirrus Perspective avionics. SR22 may also represent SR22, SR22TN, SR22T, and SR22 G5 aircraft when SR22TN or SR22T is not distinctively noted. |
| SR22TN      | Cirrus SR22 with Tornado Alley Turbonormalized engine equipped with Cirrus Perspective avionics.   |
| SR22T       | Cirrus SR22T with TCM Turbocharged engine equipped with Cirrus Perspective avionics. SR22T may also represent SR22T G5 aircraft when SR22T G5 is not distinctively noted.                                |
| SR22<br>G5  | Cirrus SR22 G5 equipped with Cirrus Perspective avionics and a maximum certified takeoff weight of 3600 pounds. SR22 G5 may also represent SR22T G5 when SR22TG5 is not distinctively noted.             |
| SR22T<br>G5 | Cirrus SR22T G5 equipped with Cirrus Perspective avionics with a maximum certified takeoff weight of 3600 pounds.  |

## Contact Information

|   |   |
|---|---|
| Air Safety and Maintenance Hot line .....   | 800.921.2737<br>218.788.3400                |
| CSIP or Training Center Inquiries           | csip@cirrusaircraft.com                     |
| Flight Training and Operations .....        | 218.788.3873<br>training@cirrusaircraft.com |
| Flight Training Network, CSIP and CTC ..... | 218.788.3882<br>csip@cirrusaircraft.com     |
| Flight Scheduling .....                     | 218.788.3217<br>training@cirrusaircraft.com |
| Public Relations .....                      | 218.788.3302                                |

Intentionally Left Blank

# Section 2

## General Operating Procedures

### General

The General Operating Procedures section describes the policies and procedures that govern all flights conducted in Cirrus owned or operated aircraft. Cirrus owned or operated flights are defined as flights conducted as Cirrus business or flying club operations in which Cirrus Aircraft provides insurance for the pilot and aircraft. Pilots flying Cirrus owned or operated aircraft must adhere to the policies and procedures described within as well as applicable regulations and the procedures and limitations described in the AFM. Failure to comply with these procedures and restrictions may result in the loss of flight privileges and or disciplinary action.

Adherence to the policies and procedures contained herein is an important component in the framework for safe flight operations but the safety of flight ultimately depends on the proficiency, judgment, and professional conduct of the pilot in command. Use this section as a guide for planning and execution of all flights in Cirrus owned or operated aircraft.

## Pilot Qualification and Training

This section describes the training and currency requirements for pilots to be eligible to act as pilot in command of a Cirrus owned or operated aircraft.

Pilots must demonstrate knowledge and proficiency to the level described in the Cirrus Syllabus Suite and FAA Practical Test Standards for the highest applicable pilot certificate held during initial and recurrent evaluations.

### Training Records

An electronic training record for each pilot will be kept and maintained by the Flight Training and Operations department. Each record will include the following documentation:

- Copy of pilot certificate,
- Copy of recent medical certificate,
- Copy of flight instructor certificate, if applicable,
- Pilot Authorization Form, completed and signed,
- Initial and Recurrent Training Syllabus, completed and signed,
- Training Mission Report, completed and signed.
- Others as applicable

Each pilot is responsible to provide the Director or Flight Operations or designee copies of new medical or pilot/instructor certificates, as applicable.

### Pilot Authorizations

In order to act as pilot in command of Cirrus owned or operated aircraft, each pilot must:

- Comply with applicable regulations pertaining to pilot certification and currency for the operation being conducted,
- Complete initial and recurrent training requirements described in this section,
- Receive training and endorsement on their Pilot Authorization and Training Records Form for each additional qualification required,
- Meet currency requirements described herein,



- Maintain a current medical certificate, valid for the operation being conducted.

The Pilot Authorization and Training Records Form will be completed upon the successful completion of initial training and will be updated after each recurrent training event. The check pilot will authorize flight duties for specific aircraft and aircraft configurations based upon the pilots certificates, training, and proficiency as demonstrated during initial training and evaluation.

### ***Corporate Flight Missions***

A pilot may perform a corporate mission in a Cirrus aircraft only if that pilot must possess a valid commercial pilot certificate and a 1st or 2nd class medical.

A corporate mission includes the following:

- Demonstration flights,
- Ferry flights,
- Customer acceptance/delivery flights,
- Formation flights,
- Flights not incidental to Cirrus business, (see next section)
- Flight that are incidental to Cirrus business but are carrying passengers or property,
- Flight instruction.

### ***Private Pilot Privileges and Limitations***

A private pilot within Cirrus Aircraft may act as pilot in command of a Cirrus owned or operated aircraft for the purpose of company business only if the flight is incidental to that business or employment and the aircraft does not carry passengers or property. This limitation does not apply to flying club flights. Flights are considered to be incidental when the aircraft is used strictly as transportation to get to a destination where Cirrus business will be conducted. Example, a private pilot who has completed initial training and is current per Cirrus policy may use a Cirrus owned or operated aircraft for transportation to a meeting.

### ***Formation Flights***

Formation flight in Cirrus owned or operated aircraft is not permitted unless the pilots are authorized by the Director of Flight Operations. Formation flight shall be conducted in accordance with the Formation Flight Manual. Formation flight is defined when 2 or more aircraft are

intentionally within 1/4 NM when the trailing aircraft continuously maintains visual contact for navigation and or collision avoidance.

### ***Flight Training, Evaluation, and Authorization***

Internal flight training will be provided by Factory Flight Instructors or CSIP instructors who are approved by the Director of Flight Operations. Initial evaluation and recurrent training will be conducted with Check Pilots who are designated by the Director of Flight Operations.

## **Initial Training**

Based upon prior experience, each pilot must complete the following courses as applicable prior to acting as pilot in command of a Cirrus owned or operated aircraft. All training and pilot authorizations are proficiency based and training times may vary.

- Transition Training, VFR (3 days),
- Advanced Transition Training, IFR (5 days),
- Airframe/Powerplant Differences Training (1 day),
- Cirrus Standardized Instructor Pilot (3 days),
- Avionics Differences (1 day),
- Advanced Avionics Differences (3 days),
- Demonstration and Right Seat Training (1 day),
- Online Icing Awareness Course (2 - 4 hours).

An initial operating experience (IOE) period applies until the pilot has 100 hours in-type and is specific to the aircraft's avionics suite, Avidyne or Perspective. For example, a pilot possessing 75 hours in a Cirrus equipped with Avidyne avionics and 75 hours in Cirrus equipped with Perspective avionics is in the IOE period for both avionics suites. Restricted weather minimums apply during the IOE period. Reference the Pilot Authorization for IOE weather minimum information.

## **Recurrent Training**

Recurrent training consists of 2 alternating events, a 6 month proficiency check and annual recurrent training. Each pilot must complete recurrent training as described in this section prior to flying a Cirrus owned or operated aircraft by the end of the 6th month. The 6 calendar month time period is reset after the completion of each recurrent training event. A grace period of one calendar month beyond

the 6 month interval is available. During the grace period, pilots shall not fly IFR. Pilots who exceed the grace period shall not exercise their flight privileges.

The objectives and requirements of each event are as follows.

### **6 Month Proficiency Check**

The 6 Month Proficiency Check may be completed with an authorized and active CSIP or a Cirrus check pilot. A copy of the IPC logbook endorsement must be sent to the Director of Flight Operations or designee upon completion of the training event.

#### *IFR Pilots*

- Complete an Instrument Proficiency Check (IPC) per 14 CFR 61.57 and objectives as detailed in the Cirrus Syllabus Suite, Recurrent Training Schedule A.

#### *VFR Pilots*

- Complete recurrent training as detailed in the Cirrus Syllabus Suite, Recurrent Training Schedule B.

For flying club operations, pilots who are actively engaged in flight training for a certificate or rating are not required to complete the 6 month proficiency check. Actively engaged means the pilot completes at least 4 training events with an authorized instructor within the previous 30 days.

### **Annual Recurrent Training**

All pilots flying Cirrus owned and operated aircraft must complete Annual Recurrent Training with a check pilot who is authorized by the Director of Flight Operations.

#### *IFR Pilots*

- Complete the knowledge test, corrected to 100%,
- Complete emergency procedures and CAPS training in an FTD or Simulator if available,
- Complete an IPC per 14 CFR 61.57 and objectives as detailed in the Cirrus Syllabus Suite, Recurrent training Schedule A,
- Complete a Flight Review per 14 CFR 61.56 and objectives as detailed in the Cirrus Syllabus Suite Recurrent Training Schedule B.

#### *VFR Pilots*

- Complete the knowledge test, corrected to 100%,

- Complete emergency procedures and CAPS training in an FTD if available,
- Complete a Flight Review per 14 CFR 61.56 as detailed in the Cirrus Syllabus Suite Recurrent Training Schedule B.

## Flight Currency

### *VFR Day and Night*

Cirrus pilots maintain VFR currency by completing each of the following items in a Cirrus aircraft:

- Comply with the Flight Review requirements per 14 CFR 61.56, and
- Complete initial training, and
- Comply with recurrent training requirements, and
- Conduct 3 takeoffs and 3 landings to a full stop within the previous 90 days, and
- Act as PIC for 10 hours within the previous 90 days,

### *IFR Day and Night*

Cirrus pilots maintain IFR currency by completing each of the following items in a Cirrus aircraft:

- Comply with all VFR currency requirements, and
- Comply with the currency requirements described in 14 CFR 61.57,
- For low-IMC currency, demonstrate the ability to execute an instrument approach to minimums within the previous 60 days.

• Note •

Initial low-IMC currency should be obtained with an authorized instructor.

## Medical Certificates

In order to exercise the privileges of a private pilot certificate the pilot must hold at least a third class medical certificate, which is valid for 24 months from the date of issue (60 months if the person is under 40).

In order to exercise the privileges of a commercial pilot certificate a pilot must hold and maintain a first or second-class medical certificate valid for 12 calendar months from the date of issue.

All Cirrus pilots shall provide a photocopy of their medical certificate to the Director of Flight Operations or designee when a new medical is received.

## Pilot Weather Minimums

Cirrus pilots will regularly assess their recent flight experience, training, and pilot certification to develop personal minimums for wind, ceiling and visibility, and instrument approach minimums. Use Figures 2.1 and 2.2 on the following pages to aid in this process.

### Wind Limits

Cirrus pilots shall not takeoff or land when the wind speed and crosswind component exceed the individual's capabilities based upon flight experience and limits described in the Envelope of Safety, Figure 2.2, considering the pilot's risk category, Figure 2.1.

Flight Operations shall cease when the following conditions are present. Pilots should assess these conditions by ensuring forecast conditions are acceptable prior to flight.

- 35Kts total sustained wind component,
- 20Kts crosswind component,
- 10Kts tailwind component,
- Limits assigned due to personal capabilities,
- When taking off or landing on ice-covered runways (braking action reported poor), the crosswind component shall not exceed 10kts,
- If the wind exceeds 25kts or the Gust factor exceeds 10kts takeoff and landing training shall not be conducted.

Unless the pilot is an authorized flight instructor, pilots providing demonstration flights shall be the sole manipulator of the flight controls during landing if the sustained wind is in excess of 15 knots, or if there is a gust factor in excess of 5 knots, or anytime it is necessary for safe flight. This policy does not preclude conducting other forms of training or demonstrations as long as the pilot performs the landing.

### Requirements for Marginal VFR Flight

Marginal VFR (Ceiling 1000-3000 and visibility 3-5 miles) operations may be conducted if the pilot in command:

- Is instrument rated, current, equipped and is prepared to obtain an IFR clearance should conditions deteriorate,

- Has a valid mission requirement i.e.: required to avoid icing or thunderstorms that IFR flight would cause the flight to come in contact with,
- Does not use marginal VFR flight for cross country travel,
- Maintains contact with appropriate ATC facility if possible,
- The minimum ceiling and visibility required for traffic pattern operations is 1500 feet and 3 miles.

## Requirements for Special VFR

The use of a Special VFR clearance is discouraged. However, operations under Special VFR are permitted if used to depart an airfield with weather below the VFR minima listed above provided the weather immediately outside the air traffic area is at least 1500 feet and 5 miles and the pilot meets the requirements for flight into Marginal VFR conditions. Reference 14 CFR 91.157.

Example: The weather at Duluth is being reported as 900 feet and 5 miles due to lake effect fog east of the airfield but the weather north and west of the field is clear. In this case, Special VFR may be used to depart the airfield. In all cases, pilots must use good judgment to avoid putting themselves in prolonged conditions of weather below 1000 feet and 3 miles.

## Minimum Visibility for IFR Takeoff

The minimum visibility for takeoff in Cirrus owned or operated aircraft is ½ mile or RVR 1800' unless the pilot is authorized for low visibility takeoffs. Authorization for low visibility takeoff allows the pilot to takeoff with a minimum of RVR 600'. A pilot conducting a low visibility takeoff must have a takeoff alternate within 50 miles of the departure airport. The current and forecasted weather conditions for the takeoff alternate must not be lower than ceiling 600 feet and visibility 2SM.

Pilots may obtain low visibility authorization during recurrent training. Pilots in their IOE period are not eligible for low visibility authorization.

## Envelope of Safety

The envelope of safety, Figure 2.2, describes weather minimums for respective pilot risk categories. The risk category matrix must be completed at each required training event. Pilot's may not dispatch if the weather conditions including wind, ceiling, and visibility, considering day or night, is at or forecasted to exceed the weather prescribed in the pilot's category.

Pilots who lack currency requirements to achieve low weather minimums but demonstrate mastery of the aircraft during an Annual Check or 6 Month Check may be placed into a higher weather category with the recommendation of the instructor and approval from the Director of Flight Operations. To be eligible for this recommendation, pilots must:

- Fly all instrument procedures during the check to the standards set forth in the Airline Transport Pilot (ATP) Practical Test Standards
- Have more than 200 flight hours in a Cirrus with the same avionics package
- The higher weather category is valid for 6 months or the next recurrent training event, whichever occurs first.

The instructor will mark the new weather minimums in the “Instructor Recommendation” section of the Annual Check paperwork and the Director of Flight Operations will sign the document.





## Guidance for Establishing Personal Weather Minimums

### General Flight Guidelines

|  | 1          | 2                       | 3                    | 4             | 5                  | Your Rating |
|--|------------|-------------------------|----------------------|---------------|--------------------|-------------|
| Years Actively Flying (Maintained FAA req. currency) | >10        | 6-10                    | 2-5                  |               | <2                 |             |
| Last Recurrent Training Event                        | <6 months  |                         | 6mo-12mo             |               | 12mo-24mo          |             |
| Certificate Held                                     | ATP or CFI | Commercial w/instrument | Private w/instrument | Private Pilot | Solo Student Pilot |             |
| Total Time   | 2000       | 1000-2000               | 750-1000             | 500-750       | <500               |             |
| Hours logged last 12 months                          | >200       | 150-200                 | 100-150              | 50-150        | <50                |             |
| Hours in Cirrus last 90 days                         | >50        | 35-50                   | 25-35                | 10-25         | <10                |             |
| Pilot Mishap Last 24 months                          |            |                         |                      | Incident      | Accident           |             |
| Cirrus Landings last 30 days                         | >10        | 6-9                     | 3-5                  | 1-2           | 0                  |             |

Age: Add 2 pts for 65 years or older  
 Time to Achieve Private Pilot: Add 2 pts for 100+ hours  
 Time to Complete Transition Training: Add 2 pts for 30+ hours  
 Crew: Subtract 1 pt for flying with licensed pilot  
 Training: Add 2 pts for not completing Cirrus Transition Training



| Pilot Category  | Total |
|---|-------|
|  | ≥ 23  |
|  | 14-22 |
|  | ≤ 13  |

Category  Not Applicable for pilots in first 100 hours of aircraft operation.

### Instrument Flight Guidelines

|   | 1   | 2     | 3     | 4    | 5  | Your Rating |
|---|-----|-------|-------|------|----|-------------|
| Years Actively Flying IFR (Maintained FAA req. currency)    | >5  |       | 1-5   |      | <1 |             |
| Hours flown IFR last 90 days                                | >35 | 25-35 | 10-25 | 5-10 | <5 |             |
| Simulated/Actual instrument hours in Cirrus in last 90 days | >3  |       | 1-3   |      | <1 |             |
| Instrument Approaches with use of Autopilot last 90 days    | >4  |       | 1-4   |      | 0  |             |
| Hand-flown Instrument Approaches last 90 days               | >2  |       | 1     |      | 0  |             |
| Received avionics specific IFR training from CSIP/CTC       | Yes |       |       |      | No |             |

Crew: Subtract 1 pt for flying with licensed pilot  
 Training: Subtract 2 pts for completing avionics specific IPC from CSIP/CTC in last 12 months.

| Pilot Category  | Total |
|---|-------|
|  | ≥ 19  |
|  | 8-18  |
|  | ≤ 7   |





**Figure 2-1**  
Guidance for Establishing Personal Weather Minimums



# KNOW YOUR LIMITS

*Cirrus Aircraft company pilots comply with and endorse this Envelope of Safety.*

| GENERAL FLIGHT MINIMUMS   |  | FLIGHT MINIMUMS                                    |  |
|---|--|--|--|
| Current Pilot Capability Category   | Wind Limit   | VFR Minimums                                       | IFR Minimums                                       |
|  | Wind: ..... 15 kts<br>X-wind: ..... 5 kts<br>Max Gust: 5 kts   | <b>Day</b><br>5000' CEILINGS<br>10 SM VISIBILITY   | 1500' / 3 SM<br>Current Reported Weather           |
|  | Wind: ..... 20 kts<br>X-wind: ..... 10 kts<br>Max Gust: 10 kts | <b>Day</b><br>3000' CEILINGS<br>10 SM VISIBILITY   | +500' / +1 SM<br>Above Published Approach Minimums |
|  | Wind: ..... 35 kts<br>X-wind: ..... 20 kts<br>Max Gust: 15 kts | <b>Night</b><br>5000' CEILINGS<br>10 SM VISIBILITY | Published Approach Minimums                        |

**Visit [www.cirrusaircraft.com/knowyourlimits](http://www.cirrusaircraft.com/knowyourlimits) to precisely determine your Pilot Capability Category**

**Infrequent Flyer**



**General**  
 +12/24 mo, since last training  
 +50 hrs last 12 mo  
 +10 hrs last 90 days

**Instrument**  
 +5 IFR hrs last 90 days  
 +5 IFR hrs last 90 days  
 +1 Thr IMC/ last 90 days  
 +0 approaches last 90 days

**Average Pilot**



**General**  
 +6/12 mo, since last training  
 +25/50 hrs last 12 mo  
 +25/50 hrs last 90 days

**Instrument**  
 +10/20 IFR hrs last 90 days  
 +10/20 IFR hrs last 90 days  
 +1-3 hrs IMC/ last 90 days  
 +1 Non-A/P approach last 90 days

**Elite Aviator**



**General**  
 +6 mo, since last training  
 +200 hrs last 12 mo  
 +200 hrs last 90 days

**Instrument**  
 +3 hrs IMC/ last 90 days  
 +3 hrs IMC/ last 90 days  
 +4 AP approaches last 90 days  
 +2 Non-A/P approach last 90 days

**Current & Proficient**

**NIGHT OPERATIONS**  
 Decrease wind limits by 5 kts  
 Increase vigilance when conducting Instrument Approach Procedures

**ICING CONDITIONS**  
 Flight Into Icing Conditions Is Hazardous  
 Refer to Airplane Flight Manual Limitations

Press "ENT" or rightmost. softkey to acknowledge 

Flying within the Envelope of Safety will not guarantee a safe flight. Pilots must comply with FARs, exercise sound judgement, and maintain a high level of flying proficiency in order to minimize the risks associated with flight.

Figure 2-2  
 Envelope of Safety

# Pilot Duty and Rest Period

## Duty Time and Rest

To exercise flight privileges, the pilot shall not exceed a duty period greater than 14 hours including a maximum of 10 hours of PIC with a maximum of 8 hours as instructor. A 10 hour rest period is required between duty days when the pilot is required to exercise his or her flight privileges.

## Flight Instructor Schedule Restrictions

In addition to the Duty Time and Rest requirements details above, Flight Instructors and Corporate Pilots must adhere to the following restrictions.

### *Flight Instructor Duty Day*

- Instructor duty day must not exceed 14 hours, with no more than 10 hours of work related activities.
- Instructor duty day is defined by when the employee becomes actively engaged in work related activities until the employee ceases work related activities during which time the Instructor will exercise his or her flight privileges.
- Work related activities include airline travel to or from the point where a flight originates or concludes.
- Instructors must be given at least 12 hours of uninterrupted rest prior to a flight departing after 2100 local time. This applies only when the late departure corresponds to the start of the Instructor's duty day.

### *Flight Time Restrictions*

- A maximum of 8 hours flight instruction (hobbs) is permitted in a 24 hour period.

### *Rest Period*

- The Instructor must have 10 hours of rest with no work related activities between daily duty days.

### *Work Period*

- The maximum working period is 8 consecutive days unless approved by the Director of Flight Operations.
- Work and travel periods that extend greater than 14 days are rare. Special time off and rest period considerations for work

periods that are greater than 14 consecutive days will be agreed upon between the Director of Flight Operations and the Instructor. Instructors must have at least one half day of rest for every 8 consecutive days of work.

- Instructors must have a minimum of 3 consecutive days off following any work period that exceeds 8 consecutive days.

### ***Exceeding Duty Day, Work Period, or Flight Time Restrictions***

Instructors may not originate a flight that will cause the Instructor to exceed duty day, flight time restrictions, or work period restrictions unless:

- The instructor receives approval from the Director of Flight Operations to exceed duty days, work period, or flight time restrictions.
- Such approval will be based on the Instructor's ability to safely complete the mission on a case by case basis.

## **Physiological Considerations**

### ***Intoxicants***

The pilot shall not consume alcohol or other intoxicants within 8 hours prior to flying and must always consider the lasting effects of alcohol the following day. Reference 14 CFR 91.17

### ***Blood Donations***

A pilot should not operate an aircraft within 72 hours after a blood donation or transfusion due to temporary lowering of oxygen carrying capacity of blood following a blood donation or transfusion.

### ***Scuba Diving***

A pilot or passenger who intends to fly after scuba diving should allow the body sufficient time to rid itself of excess nitrogen absorbed during the dive. The recommended wait times are as follows:

- Wait 12 hours - if flight will be below 8,000 feet pressure altitude *and* dive did not require a controlled ascent.
- Wait 24 hours - if flight will be above 8,000 feet pressure altitude *or* dive required a controlled ascent.

### ***Supplemental Oxygen***

Pilots are encouraged to utilize supplemental oxygen when operating aircraft above 10,000 feet MSL during the day or above 5000 feet MSL

during night time per AIM recommendations. Reference 14 CFR 91.211 for regulatory oxygen requirements.

## Aircraft Maintenance and Airworthiness

Cirrus aircraft shall be maintained in accordance with the Airplane Maintenance Manual, Pilot Operating Handbook, Federal Aviation Regulations and the Demo Care Inspection and Maintenance Program manual. Aircraft maintenance should be completed at a Cirrus Authorized Service Center or Factory Service Center.

### Pilot Responsibilities

Pilots who operate Cirrus owned or operated aircraft must comply with the following:

- Airworthiness

Pilots are responsible to determine if the aircraft meets applicable airworthiness regulations prior to each flight. If inoperative equipment is found before or during flight, pilots must comply with 14 CFR parts FAR 91.205, 91.213 and the next section of this document to determine if the aircraft is airworthy and follow the guidance described therein.

For flying club aircraft, pilots must notify the flying club manager of the discrepancy and note the discrepancy in the fleet management software to prevent future dispatch of the aircraft and to notify the Factory Service Center.

- Flight Times

Pilots are responsible for recording flight times in the Cirrus fleet management system on a per flight basis within 3 business days of completing the flight.

- Scheduled Maintenance

Pilots are responsible to ensure all scheduled maintenance items, described in the Demo Care Leaseback program, if applicable, and applicable regulations, are completed per the specified interval. Demo Care inspections must be completed at an Authorized Cirrus Service Center. Pilots are responsible to ensure the log entries completed by the ASC are correct.

- Data Base Updates

Pilots are responsible for ensuring the currency of avionic's data bases and or paper or electronic charts, as required. Pilot's who are assigned aircraft will be provided with database management training and associated accounts.

- General Aircraft Care

Aircraft will be maintained and detailed for cleanliness, proper tire inflation, etc. Cosmetic issues can be addressed at Cirrus Authorized Service Centers. All pilots will read & comply with section 8 of POH (Handling, Service, & Maintenance)

- Unscheduled Maintenance

Pilots are responsible to ensure all unscheduled maintenance items are remedied in a timely fashion by a Cirrus Authorized Service Center. Maintenance for AOG aircraft may be performed at a non Authorized Service Center. Pilots must coordinate any unscheduled maintenance that is performed at a non-ASC repair station that with the Cirrus Field Service department.

## Inoperative Equipment or Instruments Checklist

Follow the guidance in this checklist when an inoperative equipment or instrument failure has been identified either in flight or on the ground.

*In flight equipment or instrument malfunctions*

1. Follow the guidance in the appropriate AFM checklist
2. Land as soon as practical or possible as recommended by the AFM considering all factors involved.

*On ground equipment malfunctions*

1. Determine if the inoperative equipment or instrument are required per the following:
  - a. Indicated as required on the Kinds of Operations Equipment List, found in Section 2 of the AFM, for the operation being conducted,
  - b. Required by 14 CFR 91.205,
  - c. Required to be operational by an airworthiness directive for the operation being conducted.
  - d. Required for safe flight.

*If the inoperative equipment or instruments are not required per 1a, 1b, 1c, or 1d:*

- (1) Disable and placard the inoperative equipment prior to flight.
- (2) Make arrangements to repair the inoperative equipment or instruments at the earliest convenience.

*If the inoperative equipment or instruments are required per 1a, 1b, 1c, or 1d:*

- (1) Ground the aircraft,
- (2) If an ASC is located on the airport, schedule maintenance accordingly, or
- (3) If an ASC is not located on the airport, contact the Cirrus Help Desk to assist in coordinating maintenance.

## **Grounding of Aircraft**

A Cirrus pilot or mechanic has the authority to ground an aircraft anytime it is determined to not be airworthy. Inform other pilots who may fly the aircraft that the aircraft is unairworthy.



## Flight Planning

### Aircraft and Pilot Dispatch, Duluth and Grand Forks Operations

Anyone requesting a Cirrus corporate aircraft and/or pilot must receive approval from their area vice president. The Vice President's assistant will complete an aircraft request form on the Cirrus Fleet Management system. The aircraft and pilot will be dispatched based on the following criteria:

- Authorized Approval,
- Aircraft Availability,
- Pilot Availability,
- Dispatcher Approval,
- Weather.

### Flight Plans

Pilots flying Cirrus owned or operated aircraft must file and open an IFR or VFR flight plan or obtain flight following for all flights greater than 100NM from the departure airport. Flight following may only be used when radar services are known to be available. If radar is not available or if flight following is discontinued in flight, the pilot must file and open an IFR or VFR flight plan. Local area flights, such as demonstration flights or flight training flights, that remain within 100NM from the departure airport do not require a flight plan. Pilots are encouraged to receive flight following services when operating VFR on a VFR flight plan or local flight.

The pilot should complete the following flight planning responsibilities:

- Determine the best route and altitude considering: winds aloft, freezing levels, cloud bases and tops, turbulence, terrain, airspace and TFRs,
- Determine an alternate airport,
- Calculate fuel requirements,
- Verify aircraft is within weight and balance limitations,
- Verify adequate climb performance for departure procedures,
- Calculate takeoff and landing distances. Verify runway lengths for intended airports,

- File flight plan.

## IFR Alternate Airport Weather Requirements

If from 1 hour before to 1 hour after the estimated time of arrival at the destination airport, the weather is forecast to be at least 2,000 foot ceilings and 3 mile visibilities, no alternate is required, though it is important to be familiar with the area in case a diversion is required. If forecasted weather conditions are less than 2,000 feet and 3 miles, an alternate must be filed.

A pilot may only include an alternate airport in an IFR flight plan when appropriate weather reports or forecasts, or a combination of them, indicate that, at the estimated time of arrival at the alternate airport, the ceiling and visibility at that airport will be at or above the following weather minima:

- For a precision approach procedure: Ceiling 600 feet and visibility 2 statute miles.
- For a Non-precision approach procedure: Ceiling 800 feet and visibility 2 statute miles.

If an instrument approach procedure has not been published for the intended destination, the ceiling and visibility minima are those allowing descent from the MEA, approach and landing under basic VFR conditions and an alternate airport must be filed.

## Fuel Requirements

No person may operate an aircraft in IFR conditions unless there is enough fuel (considering weather reports, forecasts, and weather conditions) to:

- Complete the flight to the first airport of intended landing,
- Fly from that airport to the alternate airport,
- Fly after that for 45 minutes at normal cruising speed.

No person may begin a flight in an aircraft under VFR conditions unless (considering wind and forecast weather conditions) there is enough fuel to fly to the first point of intended landing (assuming normal cruising speed and fuel burn) and at least an additional 45 minutes beyond that point in either day or night conditions.

## Minimum Runway Length

The minimum runway length for any Cirrus aircraft is 2,500 feet or twice the expected takeoff and/or landing distance, whichever is

greater. Exceptions to the minimum runway length must be authorized by the Director of Flight Operations. Any planned off-airport landing requires written authorization from the Director of Flight Operations and applicable authorities.

## Oxygen Equipment

Prior to flight, pilots should thoroughly understand and brief passengers on how to use oxygen equipment and on signs of hypoxia.

### Pulse Oximeter

Pilots are encouraged to use a pulse oximeter to monitor oxygen saturation of the blood. Pilots should adjust the flow rate of oxygen to maintain a minimum of 90% saturation. If saturation cannot be maintained above 90%, pilots should descend appropriately.

## Weather Planning

A critical factor in a successful flight is the pilot's evaluation of weather conditions. Many weather related accidents are avoidable and could have been prevented during pre-flight if the pilot thoroughly evaluated the weather conditions. The following weather resources will be useful for evaluating the weather:

Flight Service Station: ..... 800-WX-BRIEF  
Aviation Weather Center ..... [www.aviationweather.gov](http://www.aviationweather.gov)  
FlightPlan.com..... [www.fltplan.com](http://www.fltplan.com)  
ForeFlight ..... [www.foreflight.com](http://www.foreflight.com)  
National Weather Service..... [www.nws.noaa.gov](http://www.nws.noaa.gov)

The go/no-go decisions and the route to the intended destination depend greatly on the weather at the departure airport, along the route, and at the destination. The pilot's ability to interpret and understand aviation weather is critical to the safety of flight. Follow the steps below when assessing the weather for every flight.

### **Overview**

The first step to understanding the weather conditions along the intended route is to assess the big picture. The pilot should become familiar with pressure systems, frontal systems, precipitation, areas of marginal VFR and IFR conditions, and areas of icing and turbulence. Available weather products include:

- Surface analysis chart,

- Weather radar,
- Satellite imagery.

### ***Hazards to Flight***

The second step is to identify any potential hazards for the intended flight. The pilot should become familiar with areas of marginal VFR and IFR conditions, convective activity, and areas of icing and turbulence. Available weather products include:

- Weather depiction chart,
- AIRMETs, SIGMETs and Convective SIGMETs,
- Weather radar,
- Pilot reports,
- Area forecast,
- Current and forecasted icing potential.

### ***Current Observations***

The third step is to become familiar with the current observations along the intended flight. Current weather observations within 50 miles of the departure, intended route and destination airport should be analyzed. Available weather products include:

- METARs,
- Pilot reports.

### ***Forecasted Weather***

The fourth step is to understand what the weather is expected to do during your flight. Evaluate the weather +/- 2 hours from your estimated time of arrival at the destination and planned alternate. Available weather products include:

- TAFs,
- Area forecast,
- Prognostic charts,
- Winds and temperature aloft,
- AIRMETs, SIGMETs and Convective SIGMETs.

### ***NOTAMS***

The fifth step is to become aware of any NOTAMS that may affect the flight. Pay close attention to any TFRs that may interfere with your route.

### ***Thunderstorm Flying***

Never regard a thunderstorm lightly, even when radar observations report that echoes are of light intensity. Avoiding thunderstorms is the best policy. The following are some Do's and Don'ts of thunderstorm avoidance:

- Don't land or takeoff in the face of an approaching thunderstorm. A sudden gust front or low level turbulence could cause loss of control.
- Don't attempt to fly under a thunderstorm even if you can see through to the other side. Turbulence and wind shear under the storm could be disastrous.
- Don't trust the visual appearance to be a reliable indicator of the turbulence inside a thunderstorm.
- Do avoid by at least 20 miles any thunderstorm identified as severe or giving an intense radar echo. This is especially true under the anvil of a large cumulonimbus cloud.
- Do circumnavigate the entire area if the area has 6/10 thunderstorm coverage.
- Do remember that vivid and frequent lightning indicates the existence of a strong thunderstorm.

Regard as extremely hazardous any thunderstorm with tops 35,000 feet or higher, whether the top is visually sighted or determined by radar.

### ***Temperature Minimums***

Flight training operations shall not be conducted when the outside air temperature at the surface is -20 Fahrenheit or below. The aircraft should be preheated if exposed to ground temperatures below 20 Fahrenheit for more than two hours. Do not operate the engine at speeds above 1700 RPM unless oil temperature is 100 Fahrenheit or higher and oil pressure is within specified limits of 30-60 PSI. When oil temperature has reached 100 Fahrenheit and oil pressure does not exceed 60 PSI at 2500 RPM, the engine has been warmed sufficiently to accept full rated power.

### ***Operations in Icing Conditions***

#### **• Caution •**

Flight into icing conditions is hazardous. Refer to the airplane flight manual for limitations.

A pilot is prohibited from taking off in an aircraft that has frost, snow, slush, or ice adhering to any external surface.

Icing can be expected when flying in visible moisture, such as rain, snow, or clouds, and the temperature of the aircraft is below freezing. If icing is detected, a pilot should turn on all available anti-icing equipment and do one of two things to exit the icing condition: get out of the area of visible moisture, or go to an altitude where the temperature is above freezing. The warmer altitude may not always be a lower altitude. Proper pre-flight action includes obtaining information on the freezing levels. Report icing to ATC and request new routing or new altitude if icing is encountered.

Cirrus aircraft that are certified for Flight Into Known Icing (FIKI) conditions must operate within criteria defined by FAR Part 25, Appendix C. These conditions do not include, nor were tests conducted in all icing conditions that may be encountered such as freezing rain, freezing drizzle, mixed conditions, or conditions defined as severe. Flight in these conditions must be avoided. Some icing conditions not defined in FAR Part 25 have the potential of producing hazardous ice accumulations, which exceed the capabilities of the airplane's anti-ice system, and/or create unacceptable airplane performance including loss of control. Pilots who encounter icing conditions that are outside the FAR defined conditions should divert the flight promptly. Inadvertent operation in these conditions may be detected by unusually extensive ice accumulated on the airframe in areas not normally observed to collect ice.

If the airplane encounters conditions that are determined to contain freezing rain or freezing drizzle, immediately exit the freezing rain or freezing drizzle conditions by changing altitude, turning back, or even continuing on the same course if clear air is known to be immediately ahead.

## Flight Considerations

### Turns after Takeoff

The recommended turn altitude after takeoff is a minimum of 400 feet AGL, unless obstacle departure procedures or ATC instructions dictate otherwise. When cleared to fly runway heading, pilots should maintain the heading that corresponds with the extended center line of the departure runway until otherwise directed by ATC. Drift correction should not be applied: i.e., Runway 04, with an actual magnetic heading of the runway center line being 044 degrees, fly 044 degrees.

### Noise Abatement

When operating out of noise sensitive airports pilots are encouraged to follow local noise abatement procedures and consider an RPM reduction from 2700 RPM to 2500 RPM during the climb if necessary and safe. A power reduction in an SR22T has little effect on outside noise levels and is not necessary for noise abatement.

### Weather Status

Pilots should monitor the weather along the route and destination airport for deteriorating conditions using onboard weather resources and ground based weather resources. En route Flight Advisory Service (EFAS), Flight Watch, is generally available on 122.0 anywhere in the contiguous United States. A diversion may be necessary if the weather deteriorates beyond the pilot's qualifications or capabilities.

### Aircraft Systems Status

Pilots should monitor the flight, engine and system parameters throughout the flight. Verify adequate fuel remains to reach the intended destination and switch fuel tanks as required to maintain within maximum fuel imbalance requirements.

### Pilot Status

Pilots should monitor fatigue and stress levels during the flight. A diversion may be necessary if the pilot has any reason to believe the flight can not be completed safely. Manage cockpit workload according to the procedures described in Section 3 of this manual. Pilots flying above 10,000 MSL should monitor oxygen saturation levels with a

pulse oxymeter frequently. Adjust oxygen flow rates or altitude to maintain oxygen saturation levels above 90%

## Aircraft Parking

The pilot in command of the aircraft is responsible for parking and securing the aircraft. The aircraft should be parked on a ramp or in a hangar. If the aircraft is parked outside, it should be secured with doors locked (if applicable), chocked, and tied down if possible.

Pilots are discouraged from storing keys in the tail cone or engine cowl in order to prevent aircraft damage due to FOD.

### *Duluth Ramp Operations*

- All aircraft must be parked with chocks under each main gear and the parking brake set,
- The parking first row of “T”s on the customer service ramp are reserved for customers or VIP guests only. Move corporate aircraft soon after dropping VIP guests to make room for customer parking,
- Move the aircraft from the customer service ramp to the mid field ramp for pre taxi tasks as soon as practical after engine start,
- Minimize engine RPM on the customer service ramp,
- Do not leave chocks on the customer service ramp,
- Do not direct prop wash towards an open hanger,
- Coordinate hanger usage with the Aircraft Delivery Pilot.

## Post Flight Inspection

Pilots are encouraged to conduct an abbreviated inspection after each flight in order to identify maintenance issues that may have occurred during flight. A post flight inspection may allow the pilot to identify and resolve any AOG maintenance issues and reduce aircraft downtime. Pilots should pay attention to the following items during a post flight inspection:

1. Main landing gear ..... Inspect  
Inspect the brake temperature sticker and general tire condition. Verify there are no brake fluid leaks.
2. Leading edge surfaces ..... Inspect  
Inspect for signs of impact or damage from a possible bird strike.
3. Upper and lower fuselage ..... Inspect



Inspect for signs of excessive oil leak, and condition of external antennas.

# Flight Safety

## Operating Limitations

In addition to the operating limitations specific to each aircraft type, the following actions are not permitted:

- Parachuting activities,
- Hand propped engine starts,
- Flight below 500' AGL except for takeoff and landing,
- Any activity for hire, lease, rent, profit, or reward outside the scope of Cirrus business,
- Flight over water beyond the safe gliding distance of land is not recommended.

• Note •

Pilots should ensure that adequate survival gear is readily accessible if flight over water beyond the safe gliding distance to land is required.

## Sterile Cabin

During sterile cabin operations all distractions such as music, non-flight related activities, and unnecessary communication with passengers should be minimized. A sterile cabin should be observed during departure, arrival, and abnormal/emergency operations.

## Smoking

Smoking is prohibited inside or near aircraft, hangars, and ramp areas. It is the responsibility of the pilot to ensure that passengers comply with these restrictions.

## Collision Avoidance

The pilot shall maintain vigilance for other aircraft and use all resources available to avoid any situation which could result in a collision. Pilots are encouraged to file an IFR flight plan or request traffic advisories or flight following when operating in a radar environment.

## Passenger Flight Briefing

The pilot shall provide a safety briefing, referencing the Passenger Briefing Card, to all passengers prior to each flight. The briefing shall provide instructions for the following:

- CAPS procedures in the event of a pilot incapacitation,
- Seat belts,
- Exits,
- Safety equipment on the aircraft,
- Sterile cabin procedures.

## Flying Club Procedures

The procedures described in this section apply to Cirrus flying club operations only. Flying club pilots must adhere to these procedures as well as the applicable sections of this document considering the flight operation being conducted.

### Membership Eligibility

The following individuals are eligible for membership in the Cirrus flying club:

- Direct employees of Cirrus Aircraft,
- Immediate family members of direct employees of Cirrus Aircraft.

Flying club dues for all club members will be deducted directly from the direct employee's payroll.

New members must go through the flying club orientation prior to flying any club aircraft. Orientation will review all of the flying club's policy and procedures. A copy of the flying club orientation checklist can be obtained from the flying club president or flight standards and operations. A copy of the orientation checklist form must be maintained in the individual's records folder.

### Scheduling and Dispatch Procedures

#### ***Aircraft Reservations***

Reservations for aircraft are made through the flying club fleet management system. Pilots may make a standby reservation for aircraft that have been previously reserved in order to utilize the aircraft if the primary reservation gets cancelled.

Pilots may only reserve and fly aircraft for which they are qualified per the pilot's authorization form during non instructional flights.

#### ***Instructor Reservations***

Pilots must coordinate aircraft reservations with their instructor for instructional flights. Pilots may reserve and fly any aircraft in which their instructor is qualified to fly per the instructor's authorization form.

#### ***Aircraft Dispatch***

Aircraft must be dispatched prior to commencing the flight. The flying club's fleet management system allows pilots to dispatch aircraft

provided their proficiency, currency, and aircraft maintenance are all found to be satisfactory.

Pilots must dispatch within 15 minutes of the start of their scheduled time slot. If the aircraft is not dispatched after 15 minutes, the reservation may be canceled and used by the next person.

Pilots who wish to dispatch after normal working hours may do so but should take into consideration access to the building, hangars, etc. The flying club's fleet management system will be used to dispatch the aircraft, but if flight instructor endorsements or approval is required for the flight, pilots should make alternate plans to ensure all dispatch criteria are met. Student pilots must discuss flight objectives with their instructor and have the appropriate authorizations before flying solo. During student pilot solo flights the individual's flight instructor must be on the premises to dispatch their student.

In addition to the pre flight requirements detailed 14 CFR 91.103, pilots must complete the following tasks prior to dispatching in a club aircraft:

- Schedule and dispatch the flight through the flying club fleet management system,
- Complete a dispatch form for all flights,
- Verify and record aircraft times before engine start.

Pilots who reserve the aircraft for one or more overnights must complete these additional tasks:

- Have an authorized flying club instructor review the extended forecast for the reservation period and sign the dispatch form or provide written authorization for the flight.

• Note •

By authorizing the flight, the flight instructor is acknowledging that the forecasted weather appears to be acceptable for the pilot's return leg. Ultimately, it is the pilot in commands responsibility to ensure safety of flight for all flight missions. Pilot's may not re-dispatch for the return leg if the weather is below their authorization.

- A dispatch form must be completed for the return leg and for any flights conducted during the overnight reservation prior to conducting the respective flight(s).

***Fuel Procedures Outside of Base Operations***

Pilots who purchase fuel outside of KDLH must pay out of pocket. Pilots will be reimbursed for the fuel purchased outside of KDLH at the Cirrus bulk rate, which will be updated monthly. Pilots are responsible for the price difference between the Cirrus bulk rate and the actual fuel price paid.

### ***Mountainous Areas***

Flying club members may not fly into or over areas defined as mountainous terrain by the Airman's Information Manual unless that pilot or instructor is authorized for flight into mountainous area, as noted on the member's Authorization form.

### ***No Show or Cancellation Policy***

Pilots who wish to cancel a mission may do so 24 hours in advance. When pilots cancel, they must notify any listed alternate for the aircraft via telephone. Contact information is listed on the Sky Scheduler web site. Cancellations within 24 hours prior to the flight may result in a minimum of one hour of flight time being charged to the individual if the individuals fail to properly notify any listed alternate reservation.

## **Flight Training Requirements**

### ***Stage Checks***

Stage checks are used as measuring points at various times throughout the training process.

For individuals pursuing a private pilot certificate, pilots must complete a stage check with an instructor from the Flight Standards and Operations Department prior to:

- First solo,
- First solo cross country, and
- First attempt of the practical test.

For pilots training for an instrument rating, pilots must complete a stage check at the completion of:

- Basic attitude instrument flying,
- The approach phase of training, and
- First attempt of the practical test.

For pilots training for a commercial pilot certificate, pilots must complete a stage check prior to:

- First attempt of the practical test.

### ***Pre Solo Written Test***

Prior to solo, instructors must administer and correct to 100% a pre-solo written examination. This document can be obtained from the Flight Standards and Operations Department. The original written exam must be kept in the student's record folder.

### ***Student Pilot First Solo Procedures***

After successful completion of the pre-solo written and pre-solo stage check, the student's instructor will have the final decision as to when the student may solo. The day of the solo, the instructor should fly with the student and have him or her demonstrate 3 consistent and successful landings prior to endorsing the student to fly solo.

The instructor should also ensure the student has all required documentation prior to soloing, including:

- Student pilot certificate,
- Medical,
- Photo ID, and
- Logbook with appropriate endorsements.

The student should complete 3 full stop landings and full taxi backs on their first solo. Touch and goes are not permitted on the first solo.

Weather conditions for the first solo must be:

- Visibility greater than 6 SM,
- Ceilings overcast at 3,000 or better,
- Winds less than 10 knots, with a maximum cross wind component of 5 knots.

### ***Student Pilot Solo Weather Minimums***

Student pilots may not dispatch if the actual or forecasted weather exceeds the weather limitations described in the instructor endorsement. Student pilot weather limitations must always equal or be more restrictive than the weather minimums described in the Envelope of Safety based upon the student's demonstrated proficiency.

### ***Student Pilot Limitations***

In addition to the student pilot limitations described in 14 CFR 91.61.89, student pilot may not conduct the following activities:

- Flights after sunset and before sunrise,

- Flights that are in conjunction with any Cirrus or personal business.

## **Flying Club Instructors**

To be eligible to provide instruction in Cirrus flying club aircraft, each flight instructor must:

- Hold a current CFI for private or commercial pilot training,
- Hold a CFII for instrument training,
- Complete the CSIP course for initial training,
- Complete recurrent training per the requirements detailed herein,
- Be a current member of the club.



## International Border Operations

### Pre-Flight

- Appropriate charts and flight supplements

### Personal Documentation

- Pilot certificate with “English Proficient” endorsement,
- Medical certificate,
- FCC Restricted Radiotelephone Operator Permit,
- Proof of citizenship,
  - Passport,
  - Resident alien ID Card (if required),
- Other Visa documentation as required,
- Notarized letter authorizing children to fly (if accompanied by only one parent).

### Aircraft Documentation

- Airworthiness certificate,
- Registration certificate (not temporary registration certificate),
- Operating limitations (approved aircraft flight manual),
- Weight and balance information,
- FCC Aircraft Radio Station License,
- Proof of liability insurance for the specific country,
- U.S. Customs Annual User Fee Decal (Form 339A),
- FAA Form 337 (U.S. aircraft only) or STC documentation if fuel tanks have been added in baggage or passenger compartments,
- Experimental Aircraft - Standardized Validation (for operations in Canada) or Special Flight Authorization (for operations in U.S.).

## Crossing the United States and Canadian Border

### *Departure*

- Provide passenger manifest to U.S. Customs using Electronic Advance Passenger Information System (eAPIS) at least 1 hour prior to departing from or arriving in the United States,

- <https://eapis.cbp.dhs.gov>,
- Give advance notification to Customs,
  - U.S. to Canada - contact CANPASS no less than 2 hours before and no more than 48 hours before arrival at 888-CAN-PASS (226-7277),
  - Canada to U.S. - telephone Customs office at airport of entry no less than 1 hour and no more than 23 hours before arrival; enter ADCUS in Remarks block of flight plan form,
- File and activate a VFR or IFR flight plan,
- Advise Customs if any change in ETA at airport of entry via ATC/FSS while in flight, and get the badge number and name of the Customs official that ATC/FSS is communicating with.

### ***Arrival***

- Make first landing at an airport of entry (AOE),
- Taxi to the Customs area on ramp,
  - In the U.S. - Arrive at the destination at or within 15 minutes of your planned ETA. Wait in the aircraft for the Customs official to motion you out of aircraft,
  - In Canada - if not met, find a telephone and call 888-CAN-PASS, follow directions from Customs official, obtain arrival report number,
- If inspected, present documentation as required, fill out any declaration forms and pay appropriate duties and taxes,
- Close your flight plan.

## Incident and Accident Procedures (U.S. Only)

Pilots shall immediately notify the nearest National Transportation Safety Board field office if an aircraft incident or accident occurs as defined in NTSB Part 830. The proper law enforcement agency and/or search and rescue shall be notified if necessary. The pilot should complete the Aircraft Accident and Incident Report, found in this section, after any incident or accident. The pilot should not discuss the circumstances with anyone not involved with the investigation.

### Emergency Landing

If a Cirrus aircraft makes an emergency landing at a site not designated as an airport, the pilot should not attempt to takeoff, but should immediately contact the proper authorities.

### Aircraft Incident and Accident Notification

An Aircraft Incident and Accident Report should be completed by the pilot any time a Cirrus aircraft sustains any damage or is involved in an incident or accident. The information may be useful in a future investigation. The report form is found in this manual.

### NTSB Field Offices

#### *Eastern Region*

|                   |              |
|-------------------|--------------|
| Atlanta, GA ..... | 404-562-1666 |
| Miami, FL.....    | 305-597-4610 |
| Ashburn, VA ..... | 571-223-3930 |

#### *Central Region*

|                    |              |
|--------------------|--------------|
| Chicago, IL .....  | 630-377-8177 |
| Denver, CO.....    | 303-373-3500 |
| Arlington, TX..... | 817-652-7800 |

#### *Western Region*

|                   |              |
|-------------------|--------------|
| Seattle, WA.....  | 206-870-2200 |
| Gardena, CA ..... | 310-380-5660 |

#### *Alaska Region*

|                     |              |
|---------------------|--------------|
| Anchorage, AK ..... | 907-271-5001 |
|---------------------|--------------|

# Aircraft Incident and Accident Report

Date of accident: \_\_\_\_\_ Time: \_\_\_\_\_

Pilot's Name: \_\_\_\_\_ Phone No: \_\_\_\_\_

Owner and/or Operator: \_\_\_\_\_

Aircraft Type: \_\_\_\_\_ N#: \_\_\_\_\_

Type of Event (circle one):    Accident                  Incident                  Damage

Last point of departure: \_\_\_\_\_

Point of intended landing: \_\_\_\_\_

Position of aircraft in reference to an easily defined geographical point:

\_\_\_\_\_  
\_\_\_\_\_

Number of persons aboard: \_\_\_\_\_ Fatalities: \_\_\_\_\_ Injured: \_\_\_\_\_

Description of injuries: (if applicable): \_\_\_\_\_

\_\_\_\_\_  
\_\_\_\_\_

Names of passengers: \_\_\_\_\_

\_\_\_\_\_  
\_\_\_\_\_

Weather conditions (attach weather print-off if available):

Wind Direction: \_\_\_\_\_ Wind Velocity: \_\_\_\_\_

Visibility: \_\_\_\_\_ Sky Condition: \_\_\_\_\_

Temp/Dew point: \_\_\_\_\_ Altimeter Setting: \_\_\_\_\_

Other \_\_\_\_\_

Eye Witnesses:

Name

Phone Number

1. \_\_\_\_\_

2. \_\_\_\_\_

3. \_\_\_\_\_





# Section 3

## Standard Operating Procedures

### General

The Standard Operating Procedures section describes the recommended procedures when operating a Cirrus aircraft during visual and instrument conditions. This information should serve as a framework for aircraft and avionics management. These standard operating procedures were developed by and are used by professional pilots and flight instructors at Cirrus Aircraft. The procedures outlined are considered the best operating practices while flying Cirrus aircraft; however, these procedures may not be inclusive to all variables encountered in the national airspace system. Cirrus pilots are encouraged to follow the procedures outlined in this manual, use their best judgment, and adapt these procedures when handling non-standard situations.

• Note •

Checklist procedures in the FOM have been designed to accommodate all aircraft equipped with Cirrus Perspective avionics. In each checklist, items that are specific to only certain aircraft will be noted in each procedure. Unless specified, items will apply to all aircraft with Cirrus Perspective avionics.

Utilizing these standard operating procedures will enhance the situational awareness of the pilot in both single pilot and crew situations and allow for timely completion of tasks in the aircraft. Adhering to these procedures will help the pilot take full advantage of the aircraft's capabilities while maintaining a high level of safety.

• Note •

Procedures in this publication are derived from procedures in the FAA Approved Airplane Flight Manual (AFM). Cirrus Aircraft has attempted to ensure that the data contained agrees with the data in the AFM. If there is any disagreement, *the Airplane Flight Manual is the final authority.*

## Single Pilot Resource Management

Single Pilot Resource Management (SRM) is the ability to manage all the resources available to a pilot to ensure that the successful outcome of the flight is never in doubt.

The majority of Cirrus aircraft operations are conducted as single-pilot. The workload associated with flying the aircraft, configuring and monitoring avionics, communicating with air traffic control, and decision making requires pilots to efficiently manage all tasks while maintaining positive aircraft control at all times. The following SRM procedures have been adapted from cockpit procedures common to dual pilot transport category aircraft.

General aviation pilots have a great deal of latitude on how to manage and operate aircraft. To ensure the highest levels of safety, it is strongly recommended that these single pilot operating procedures be incorporated into the operation of the aircraft.

### Priority of Tasks

The following is a list of priorities that apply to any situation encountered in flight. Pilots must adhere to these priorities during every flight.

#### 1. Maintain Aircraft Control

The number one priority of the pilot is to maintain aircraft control. Pilots should maintain a high level of vigilance during periods of high and low workload to ensure aircraft control is always maintained.

#### 2. Navigation

Once aircraft control is assured, pilots should set and verify that the avionics are correctly configured for navigation. This task includes creating and modifying flight plans, selecting proper navigation sources and/or tuning navigation frequencies. Use of the autopilot may assist the pilot with accomplishing these tasks. Pilots should monitor flight parameters closely while programming various avionics equipment.

#### 3. Communication

Communication is an important task in the aircraft but follows aircraft control and navigation as a priority. This task includes setting assigned frequencies, controlling communication volume and responding to ATC instructions. Communicate intentions and



relay instructions clearly to ATC/CTAF while maintaining aircraft control.

• Note •

Using Standard Operating Procedures will aid the pilot in timely completion of required tasks and allow the pilot to maintain high levels of situational awareness.

## Using Standard Operating Procedures

The use of Standard Operating Procedures will allow for single-pilot operations with higher levels of safety and efficiency. Following standard procedures during flight operations will develop habit patterns through repetition that allow pilots to be most efficient while completing tasks and configuring the aircraft for various phases of flight. Section 3 of this manual details and describes the recommended procedures for operating a Cirrus aircraft in a normal flight environment for both VFR and IFR operations.

## Use of All Available Resources

The use of all available resources during flight in single-pilot operations will allow pilots to make better and more timely decisions. Many resources are available to pilots such as: ATC, Flight Watch or Flight Service Stations, on-board weather displays, on-board chart displays, and even passengers.

## Collision Avoidance

It is the responsibility of the pilot in command to see and avoid other aircraft. Pilots should use care during all movement on the ground. Read back all hold short instructions and visually verify that runways are clear prior to crossing. Use of SafeTaxi and/or Charts will increase the pilot's situational awareness during movement on the ground.

While in visual conditions pilots should regularly scan outside the aircraft in sweeping ten degree increments. Pilots are encouraged to use resources on board the aircraft to identify possible threats before they become a hazard. Displaying traffic on the PFD inset map will continuously assist pilots to see and avoid other traffic. Remember, non-transponder-equipped aircraft will not be detected by on-board traffic systems.

## Terrain Avoidance

Pilots are at greatest risk for controlled flight into terrain (CFIT) accidents during high workload situations (departure and arrival), in unfamiliar terrain or airspace, and in restricted visual conditions (IMC or night). Chances of a loss of control or CFIT accident is greatly increased when VFR flight is continued into IMC conditions. Proper pre-flight weather planning will reduce the likelihood of accidental flight into IMC conditions. Adhere to these guidelines to reduce the likelihood of a CFIT accident.

- Verify that departure, enroute and destination weather conditions allow for safe completion of the flight,
- Become familiar with all terrain and obstacle hazards for the planned route and plan the route and altitudes accordingly,
- Become familiar with any departure procedures and brief the departure procedures prior to takeoff,
- Exercise sterile cabin procedures during high workload periods,
- Reference TAWS information in mountainous terrain. Ensure the the range is set to less than 100NM,
- Maintain situational awareness at all times using the tools onboard the aircraft including: moving map displays, TAWS, and navigation information,
- Proceed with caution and maintain high levels of vigilance when operating in unfamiliar terrain, especially during low or restricted visibility.

## Checklist Philosophy

When used properly, checklists enhance the safety of flight by confirming the aircraft is appropriately configured for the flight condition. At the same time, checklists expedite the completion of procedures that are necessary to transition to subsequent phases of flight.

The electronic checklist in the MFD should be used anytime the MFD is running. Use of electronic checklists will help keep the cockpit organized and functional. Use a paper checklist whenever the MFD electronic checklists are not available.

## Classification of Checklists

All checklist procedures can be assigned one of three classifications:

- Normal: Procedures used during normal flight operations. Normal checklists can be found in the Normal Procedures section of the POH.
- Abnormal: Procedures used in response to system failures and malfunctions that, while not immediately threatening, may affect safety of flight if not addressed. Abnormal checklists can be found in the Abnormal Procedures section in the POH.
- Emergency: Procedures used in response to system failures and malfunctions that are an immediate threat to the safety of flight. Emergencies require immediate action by the flight crew to ensure a safe outcome. Emergency checklists can be found in the Emergency Procedures section of the POH.

## Checklist Completion for Normal Procedures

Normal procedure checklists can be completed as a flow pattern or a do-list. The appropriate method for checklist completion for each normal procedure is indicated in the procedures section for each phase of flight.

**Do-List:** A do-list checklist is executed by reading the checklist item and selecting the appropriate condition of the item. Do-lists are used when procedure sequence and/or item condition is critical to completion of the procedure and when ample time exists for completion of the checklist.

**Flow Pattern:** The term “flow pattern” refers to a logical path through the cockpit that the pilot will move along during the execution of the checklist. Flow patterns use a “do and verify” approach to checklist completion. The items and their conditions are memorized and executed without immediate reference to the written checklist. Following completion of the flow pattern, the checklist is referenced as soon as time and workload permit to ensure procedure completion.

When used properly, flow patterns allow timely configuration of the aircraft for the appropriate flight condition. Flow patterns are used when procedure sequence and aircraft condition are not critical and there is an operational advantage to executing the checklist items in a timely manner.

## Pre-Flight Inspection

The pre-flight inspection should be completed as a flow pattern when the pilot is familiar with the aircraft pre-flight inspection checklist. Always refer to the aircraft checklist after the flow to verify that all items have been completed.

### Documentation

The following documents must be in the aircraft for the flight:

- Certificate of Airworthiness,
- Registration,
- FAA Approved Airplane Flight Manual and Pilot's Operating Handbook, including weight and balance,
- Radio Station License for International Operations,
- Appropriate Avionics Publications.

### Equipment

The following equipment should be carried in the aircraft when appropriate:

- Survival kit (appropriate to the climate and conditions),
- Approved flotation devices for flights over water beyond gliding distance to land,
- Supplemental oxygen system for high altitude operations,
- Chocks, tie downs, extra oil, tow bar, engine and airplane covers.

### Ground Icing

A visual inspection and tactile check of the entire aircraft is required before takeoff whenever conditions conducive to ground icing are present. Pilots are prohibited from taking off in an aircraft that has frost, snow, slush, or ice adhering to any external surface.

FIKI - Dispatch into known icing conditions is prohibited if porous panels do not fully "wet-out", or if there is a persistent annunciation of any anti-ice system crew alert system (CAS) message.

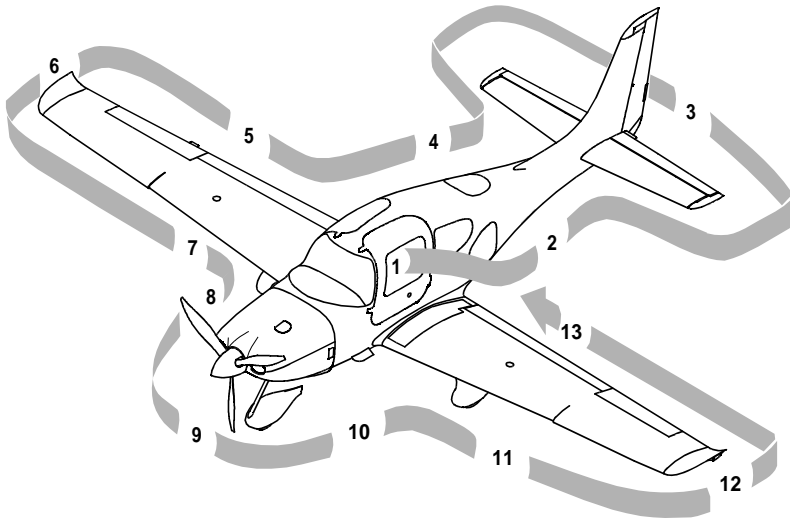

SR22\_OP02\_2659

## Procedure (Flow Pattern)

### 1. Cabin

- a. Required Documents..... On Board  
*Ensure Airworthiness Certificate is visible to occupants, Registration Certificate, Pilot's Operating Handbook and Aircraft Weight and Balance are on board the aircraft.*
- b. Avionics Power Switch.....OFF
- c. Bat 2 Master Switch..... ON
- d. PFD .....Verify ON  
*Verify on and alignment process beginning.*
- e. Essential Bus Voltage..... 23-25 Volts  
*Verify with voltmeter located on the left hand side of the PFD.*
- f. Flap Position Light ..... OUT  
*Verify flap position light is not illuminated to ensure isolation diodes are functioning properly.*
- g. Bat 1 Master Switch..... ON
- h. Avionics Cooling Fan ..... Audible

*Listen for cooling fan operation.*

- i. Oxygen Masks/Cannulas and Hoses .....Check Condition
- j. Oxygen System .....ON
  - (1) Quantity.....Verify adequate supply for flight with reserve
  - (2) Flow ..... Check flowmeter on all masks
  - (3) Oxygen System..... OFF
- k. Avionics Master Switch (FIKI).....ON  
*Avionics Master and audio panel must be turned on and flaps must be 100% down in order to test stall warning on ground.*
- l. Flaps..... 100%, Check Lights ON  
*Visually verify down and ensure light corresponds with flap setting.*
- m. PITOT HEAT Switch .....ON  
*FIKI - Limit ground operations of Pitot Heat to 45 seconds. Operations of Pitot Heat in excess of 45 seconds while on the ground may cause excessive temperature on stall warning transducer faceplate and surrounding wing skin.*
- n. Lights..... Check Operation  
*Verify operation of required interior (overhead, instrument and panel lights) and exterior (navigation, landing, anti-collision, and ice lights). Strobe lights are required for all flight operations. Navigation lights are required for all night operations.*
- o. Stall Warning Faceplate (FIKI) ..... Perceptibly Hot  
*Stall warning faceplate should become hot when Pitot Heat is on. Use caution to avoid burns when checking system operation.*
- p. Stall Warning .....Test  
*Test stall warning system by applying suction to the stall warning system inlet and noting the warning horn sounds.*  
*FIKI - Verify Stall Warning System audio annunciation operation by lifting stall warning vane with wooden tooth pick or tongue depressor. Stall warning vane should be very hot. Avionics Master and audio panel must be turned on and flaps must be 100% down in order to test stall warning on ground.*

- q. Pitot Heat.....Perceptibly Hot  
*Verify the pitot tube is hot.*
  - r. Fuel Quantity .....Check  
*Ensure fuel quantity is sufficient for planned flight and corresponds to fuel amount in tanks and on MFD.*
  - s. Fuel Selector .....Select Fullest Tank  
*Switch fuel selector to the fullest tank. Maximum fuel imbalance: 7.5 (SR20), 10 gal SR22(T),(TN),(G5).*
  - t. Alternate Static Source..... NORMAL  
*Visually verify alternate static source located near pilot's right knee, above circuit breaker panel is in the NORMAL position.*
  - u. Bat 1 and 2 Master Switches.....OFF  
*Ensure both battery switches are turned off.*
  - v. Circuit Breakers ..... IN  
*Ensure all circuit breakers are in and none are in re-settable (tripped) condition.*
  - w. Fire Extinguisher.....Charged and Available  
*Inspect extinguisher and ensure pin and safety wire are intact. There is no gauge to measure quantity.*
  - x. Emergency Egress Hammer .....Available  
*Hammer should be stowed securely inside lid of the arm rest between the front seats.*
  - y. CAPS Handle ..... Pin Removed  
*Remove safety pin and stow for remainder of flight. Be sure to replace CAPS cover after pin removal as it is a required placard. Consider delaying this checklist item until all passengers are boarded and provide a passenger CAPS briefing at that time.*
2. Left Fuselage
- a. Door Lock .....Unlock  
*Ensure the door lock is in the unlocked position to allow outside entry into the aircraft in the event of an accident.*
  - b. COM 1 Antenna..... Condition and Attachment



*Visually check condition of antenna and surrounding area of fuselage.*

- c. Wing/Fuselage Fairing..... Check  
*Visually inspect the wing root fairing for attachment along upper and lower surfaces of wing root.*
  - d. COM 2 Antenna.....Condition and Attachment  
*Visually check condition of antenna and surrounding area of fuselage.*
  - e. Transponder Antenna .....Condition and Attachment  
*The transponder antenna is located on the bottom side of the airplane, just aft of the baggage compartment bulkhead on the RH side of the aircraft.*
  - f. Baggage Door ..... Closed and Secure  
*Physically check for locked and secured door and ensure keys are removed.*
  - g. Static Button ..... Check for Blockage  
*Ensure removal of static covers if used and check for any blockage within static port openings.*
  - h. Parachute Cover..... Sealed and Secured  
*Visually inspect area on top rear of fuselage directly behind rear top window for any cracks.*
3. Empennage
- a. Tie Down Rope..... Remove  
*Visually verify tail tie down is removed and stowed.*
  - b. Horizontal and Vertical Stabilizers..... Condition  
*Inspect leading edges and top of vertical stabilizer for any abnormalities. Ensure the clear tape covering inspection hole inside of elevator horn is intact.*
  - c. Elevator and Tab..... Condition and Movement  
*Check elevator for range of motion. Inspect tab on left side of elevator for condition. Visually inspect counter weight inside elevator horn for security. Check all hinges, bolts, and cotter pins.*
  - d. Rudder..... Freedom and Movement

*Inspect for full range of motion. Inspect all hinges, bolts, and cotter pins from the left side of the rudder. Visually inspect counter weight inside top leading edge of rudder horn for security.*

- e. Rudder Trim Tab .....Condition and Security
- f. Attachment Hinges, Bolts and Cotter Pins ..... Secure  
*Verify all moveable control surfaces are secure and all bolts and cotter pins are in place.*

4. Right Fuselage

- a. Static Button ..... Check for Blockage  
*Ensure removal of static covers and check for any blockage within static port openings.*
- b. Wing/Fuselage Fairings .....Check  
*Visually inspect the wing root fairing for attachment along upper and lower surfaces of wing root.*
- c. Door Lock ..... Unlocked  
*Ensure the door lock is in the unlocked position to allow outside entry into the aircraft in the event of an accident.*

5. Right Wing Trailing Edge

- a. Flaps and Rub Strip (if installed) .....Condition and Security  
*Inspect flap hinges, bolts and cotter pins for security and verify a small amount of movement when flaps are in an extended position. Visually inspect rub strip for abnormal chafing.*
- b. Aileron and Tab..... Condition and Movement  
*Verify full deflection of right aileron and ensure opposite deflection of left aileron. Inspect control assemblies located near the leading edge of outboard and inboard aileron. Inspect the security of the bolt located under the inboard edge of the aileron.*
- c. Aileron Gap Seal .....Security  
*Visually inspect the aileron gap seal for attachment along the entire surface.*
- d. Hinges, Actuation Arm, Bolts and Cotter Pins .....Security  
*Verify all moveable control surfaces are secure and all bolts and cotter pins are in place.*

6. Right Wing Tip
  - a. Tip ..... Attachment  
*Ensure all screws are in place on upper and lower surfaces. Visually inspect for damage to leading edge, trailing edge, and wing tip.*
  - b. Strobe, Nav Light and Lens ..... Condition and Security  
*Inspect for security of lights and lighting covers.*
  - c. Fuel Vent (underside) ..... Unobstructed  
*Verify there are no obstructions to the fuel vent.*
7. Right Wing Forward and Main Gear
  - a. Leading Edge and Stall Strips ..... Condition  
*Inspect leading edge for any abnormalities. Ensure both stall strips are secured.*
  - b. Fuel Cap ..... Check Quantity and Secure  
*Visually check fuel is at desired amount and the fuel cap is secured and locking tab is facing rearward. Lock fuel caps as desired.*
  - c. TKS Fluid Reservoir (FIKI) ..... Verify Desired Quantity  
*Check cap condition and security. Minimum dispatch level for flight into known ice is 5 gallons between the two tanks. Use only approved fluid meeting DTD-406B standards.*
  - d. Fuel Drains (2 underside) ..... Drain and Sample  
*Use a clear fuel strainer and sample fuel from the main tank and the collector tank. Visually check color for grade of fuel and inspect for contaminants. Ensure fuel drains do not leak after taking sample. Do not use the same sample cup used to drain the TKS system.*
  - e. TKS Fluid Vent (underside wing) (FIKI) ..... Unobstructed  
*Verify there are no obstructions to the TKS fluid vent.*
  - f. Wheel Fairings ..... Security, Accumulation of Debris  
*Physically ensure security of wheel pants. Check for and remove any debris in wheel pants (ice or slush may have formed during taxi).*
  - g. Tire ..... Condition, Inflation and Wear

*Inspect tire for excessive wear to include flat spots, bald spots or visible tire chords. Ensure adequate tire inflation. Moving the aircraft may be necessary to visually inspect the entire tire for overall condition if excessive wear is suspected.*

- h. Wheel and Brakes .....Condition  
*Inspect the area directly surrounding the wheel for evidence of fluid leaks. Visually inspect brake temperature sticker for evidence of overheating. (Center of blue inspection disc is white in a normal condition, dark gray when overheated.)*
- i. Chocks and Tie Down Ropes .....Remove  
*Ensure all wheel chocks and tie down ropes are removed and stowed.*

8. Nose, Right Side

- a. Vortex Generator .....Condition  
*Inspect condition of vortex generator and ensure it has not been damaged.*
- b. Ice-inspection Light (FIKI).....Condition/Security  
*Inspect for security of light and lighting cover. Ice lights are required for night operations in icing conditions.*
- c. Cowling..... Attachments Secure  
*Visually inspect each cam lock for secure fitting along top and side of cowls. Screws should be inspected along center bottom and directly behind spinner. Two screws behind the spinner will be removed to de-cowl or to add/remove winterization kits. It is imperative that these screws not be overlooked during pre-flight as severe cowl damage will result if engine is started without them in place.*
- d. Cabin Air Vent..... Unobstructed  
*Visually inspect air vent for debris or obstructions which could prevent fresh air flow to the cabin.*
- e. Exhaust Pipe ..... Condition, Security and Clearance  
*SR20/SR22[(T),(TN),(G5)]- Ensure there is adequate clearance between lower cowling and exhaust pipes and verify they are secure with some movement. Inspect heat shield for security.*

*SR22TN/SR22T - Ensure each tailpipe is secure by grasping the end of the tailpipe. Loose tailpipes should be serviced prior to flight. Do not fly an aircraft with loose tailpipes.*

- f. Gascolator (underside)..... Drain for 3 Seconds, Sample  
*Use clear fuel strainer and drain for 3 seconds. Inspect fuel sample for contaminants and proper color. Ensure drain does not leak after taking sample.*
  
- 9. Nose Gear, Propeller and Spinner
  - a. Tow Bar ..... Remove and Stow
  - b. Strut..... Condition  
*Inspect strut and fairing for condition and security.*
  - c. Wheel Fairing ..... Security, Accumulation of Debris  
*Ensure fairing is not damaged and is attached securely.*
  - d. Wheel and Tire ..... Condition, Inflation and Wear
  - e. Propeller ..... Condition, Check Ground Clearance  
*Inspect the propeller blades for smoothness and ensure there are no significant nicks in the blades. Check for any damage to the tips of each blade.*  
  
*SR22T or equipped - Verify oleo strut is properly inflated by checking ground clearance of the propeller. Clearance should be approximately 9 inches from blade tip to ground.*
  - f. Spinner ..... Condition, Security, and Oil Leaks  
*Ensure spinner screws are secure, check for any oil on spinner, propeller blades or cowling.*
  - g. Air Inlets ..... Unobstructed  
*Verify air inlets are free of obstructions and ensure cowling screws are secured. If winterization kits are installed, check for security of the kit and screws.*
  - h. Alternator..... Condition  
*SR20 - Physically verify security of alternator, electrical connections and belt.*  
  
*SR22/SR22TN/SR22T - Physically verify security of alternator and electrical connections.*

10. Nose Left Side

- a. Landing Light..... Condition

*Verify landing light is intact and cover is secure with no cracks.*

- b. Engine Oil ..... Check 6-8 quarts  
*Visually verify oil quantity, ensure oil cap is tightly secured and both latches on the oil door are locked.*  
*When opening oil door, do not let latches snap back against oil door as this may lead to paint chipping and cracking.*
- c. Cowling ..... Attachment Secure  
*Visually inspect each cam lock for secure fitting along top and side of cowls. Screws should be inspected along center bottom and directly behind spinner.*
- d. External Power ..... Door Secure  
*Ensure cam lock is secured. Phillips head screw driver may be required to secure.*
- e. Ice-inspection Light (FIKI) ..... Condition/Security  
*Inspect for security of light and lighting cover. Ice lights are required for night operations in icing conditions.*
- f. Windshield Spray Nozzles (FIKI) ..... Condition/Security  
*Ensure nozzles are securely fitted to the cowling and are unobstructed.*
- g. Vortex Generator ..... Condition  
*Inspect condition of vortex generator and ensure it has not been damaged.*
- h. Exhaust Pipes ..... Condition, Security and Clearance  
*SR20/SR22 - Ensure there is adequate clearance between lower cowling and exhaust pipes and verify they are secure with some movement. Inspect heat shield for security.*  
*SR22TN/SR22T - Ensure each tailpipe is secure by grasping the end of the tailpipe. Loose tailpipes should be serviced prior to flight. Do not fly an aircraft with loose tailpipes.*

11. Left Main Gear and Forward Wing

- a. Wheel Fairings ..... Security, Accumulation of Debris  
*Physically ensure security of wheel pants. Check for debris in wheel pants (ice or slush may have formed during taxi).*
- b. Tire ..... Condition, Inflation and Wear

*Inspect tire for excessive wear to include flat spots, bald spots or visible tire chords. Ensure adequate tire inflation. Moving the aircraft may be necessary to visually inspect the entire tire for overall condition if excessive wear is suspected.*

- c. Wheels and Brakes ..... Condition  
*Inspect the area directly surrounding the wheel for evidence of fluid leaks. Visually inspect brake temperature sticker for evidence of overheating. (Center of blue inspection disc is white in a normal condition, dark gray when overheated.)*
  - d. Chock and Tie Down Ropes ..... Remove  
*Ensure all wheel chocks and tie down ropes are removed and stowed securely to prevent hazards to others.*
  - e. Fuel Drains (2 underside) ..... Drain and Sample  
*Use a clear fuel strainer and sample fuel from the main tank and the collector tank. Visually verify color for grade of fuel and inspect for contaminants. Ensure fuel drains do not leak after taking sample.*
  - f. TKS Fluid Vent (underside wing) (FIKI) ..... Unobstructed  
*Verify there are no obstructions to the TKS fluid vent.*
  - g. TKS Fluid Reservoir (FIKI) ..... Verify Desired Quantity  
*Check cap condition and security. Minimum dispatch level for flight into known ice is 5 gallons between the two tanks. Use only approved fluid meeting DTD-406B standards.*
  - h. Fuel Cap ..... Check Quantity and Secure  
*Visually verify fuel is at desired amount and that the fuel cap is secured and locking tab is facing rearward.*
  - i. Leading Edge and Stall Strips ..... Condition  
*Inspect leading edge for any abnormalities. Ensure both stall strips are secured.*
12. Left Wing Tip
- a. Fuel Vent (underside) ..... Unobstructed  
*Verify there are no obstructions to the fuel vent.*
  - b. Pitot Mast (underside) ..... Inspect  
*Ensure cover removed and stowed, inspect tube inside and out for any obstructions. Pitot mast may be hot.*

- c. Strobe, Nav Light and Lens .....Condition and Security  
*Inspect for security of lighting covers.*
- d. Tip.....Attachment  
*Ensure all screws are in place on upper and lower surfaces. Visually inspect for and damage to leading edge, trailing edge and wing tip.*

13. Left Wing Trailing Edge

- a. Aileron ..... Freedom of Movement  
*Verify full deflection of right aileron and ensure opposite deflection of left aileron. Inspect control assemblies located near the leading edge of outboard and inboard aileron. Inspect the security of the bolt located under the inboard edge of the aileron.*
- b. Aileron Gap Seal .....Security  
*Visually inspect the aileron gap seal attachment along the entire surface.*
- c. Flap and Rub Strip.....Condition and Security  
*Inspect flap hinges, bolts, and cotter pins for security and verify a small amount of movement when flaps are in an extended position. Visually inspect rub strip for abnormal chafing.*
- d. Hinges, Actuation Arm, Bolts and Cotter Pins ..... Secure  
*Verify all moveable control surfaces are secure and all bolts and cotter pins are in place.*

**Ice Protection System Pre-Flight Inspection**

The ice protection system should be tested following the normal pre-flight inspection. An inspection of the ice protection system including verification of proper mode selection and adequate fluid flow is required any time use of the system may be necessary during flight.

FIKI - Dispatch into known icing conditions is prohibited if porous panels do not fully “wet-out” or persistent annunciation of any anti-ice system CAS messages.

System priming is only necessary if planning to enter forecast icing conditions or IMC and OAT is less than 41°F / 5°C.



• Note •

The following procedure is designed to be performed immediately following the normal pre-flight inspection. Items normally checked during that inspection will not be repeated here. Reference the AFM supplement for a complete, stand-alone checklist.

Prior to conducting a pre-flight inspection of the ice protection system, ensure the aircraft is positioned in an area in which dripping anti-ice fluid will not cause a slipping hazard to other persons. Pilots should not operate the anti-ice system in high-traffic areas or inside hangars.

During long periods of non-use, the porous panel membranes may dry out which can cause uneven fluid flow during subsequent operation. Perform the pre-flight inspection every 30 days to keep porous panel membranes wetted.

1. Cabin

- a. Battery 1 Master Switch .....ON
- b. Cabin Doors .....Close  
*Close doors in order to prevent anti-ice fluid from the windshield sprayer from entering cabin.*
- c. WIND SHLD Push-Button .....Press  
*Verify Evidence of anti-ice fluid from spray nozzles.*
- d. ICE PROTECT System Switch.....ON
- e. ICE PROTECT Mode Switch..... NORM  
*Verify Metering Pump Cycle is 30s on, 90s off. Check anti-ice fluid endurance indications on the MFD.*
- f. ICE PROTECT System Switch.....OFF
- g. PUMP BKUP Switch.....ON  
*Verify Metering Pump is continuously on. Check anti-ice fluid endurance indications on the MFD.*
- h. PUMP BKUP Switch.....OFF
- i. ICE PROTECT System Switch.....ON
- j. ICE PROTECT Mode Switch..... HIGH  
*Verify Metering Pump is continuously on. Check anti-ice fluid endurance indications on the MFD. Pump should remain on HIGH for walk-around inspection of panels.*

2. Empennage
  - a. Stabilizer Porous Panels.....Condition/Security  
*Check condition and security of porous panels. Verify evidence of anti-ice fluid along length of panels.*
3. Right Wing Forward and Main Gear
  - a. Porous Panels.....Condition/Security  
*Check condition and security of porous panels. Verify evidence of anti-ice fluid along length of panels.*
4. Nose Gear, Propeller, Spinner
  - a. Slinger Ring ..... Evidence of Anti-Ice Fluid  
*Verify anti-ice fluid is dripping from the bottom of the slinger ring. This will ensure ice protection to the prop.*
5. Left Wing Forward and Main Gear
  - a. Porous Panels.....Condition/Security  
*Check condition and security of porous panels. Verify evidence of anti-ice fluid along length of panels.*
6. Cabin
  - a. ICE PROTECT System Switch .....OFF
  - b. Anti-ice Fluid Quantity .....Check  
*Verify minimum 5 gallons if dispatching into icing conditions.*
  - c. Bat 1 and 2 Master Switches .....OFF  
*Ensure both battery switches are turned off.*

## Before Engine Start

Complete the Before Starting Engine checklist as a do-list to start the aircraft engine. Before starting the engine verify all pre-flight items are complete and all emergency equipment is on board and stored in the proper location. Consider removing the CAPS pin after all occupants have boarded the aircraft and are seated with seat belts fastened. Ensure seats are locked into position by verifying the control handle is in the full down position.

During engine start, the aircraft should be positioned so that the propeller blast will not adversely affect any aircraft, hangar, or person.

## Passenger Flight Briefing

The pilot should provide a safety briefing, referencing the Passenger Briefing Card, to all passengers prior to each flight. The briefing shall provide instructions in the event of a pilot incapacitation including the use of the CAPS, seat belts, exits, and any other safety equipment on the aircraft. The pilot should also discuss sterile cabin procedures and other information as necessary.

At a minimum, passengers should be briefed on the following items:

- CAPS,
- Smoking,
- Seatbelts,
- Doors,
- Emergency Exits/Egress Hammer,
- Use of Oxygen.

## Procedure (Do-List)

1. Pre-flight Inspection ..... COMPLETE  
Verify pre-flight inspection has been completed and all items are completed.
2. Weight and Balance ..... Verify within Limits

• WARNING •

Ensure that the airplane is properly loaded and within the AFM's weight and balance limitations prior to takeoff.

3. Emergency Equipment ..... ON BOARD

Verify all safety equipment required for flight is on board and in working order. This may include, but is not limited to, personal flotation equipment, life raft, flashlight, batteries, cold weather equipment, etc.

**4. Passengers ..... BRIEFED**

Ensure all passengers have been briefed according to the Cirrus Aircraft Passenger Briefing Card and verify a briefing card is located in each seat back. See passenger briefing items listed in previous section. Verify CAPS pin is removed.

**5. Seats, Seatbelts and Harnesses..... ADJUST AND SECURE**

Verify all seats, including seat backs and slides are locked, and belts and harnesses are securely adjusted and fastened for all occupants of the aircraft.

**• Caution •**

Crew seats must be locked in position and control handles fully down before flight. Ensure seat belt harnesses are not twisted.

## Engine Start

The Engine Start checklist should be accomplished as a do-list. Select the proper engine start procedure based on outside air temperature and internal engine temperature.

If the engine has been exposed to temperatures at or below 20°F (-7°C) for a period of two hours or more, the use of an external pre-heater and external power is highly recommended. Failure to properly pre-heat a cold soaked engine may result in congealing within the engine, oil hoses, and oil cooler with a potential loss of oil flow, possible internal damage to the engine, and subsequent engine failure.

If the engine does not start during the first few attempts, or if the engine firing diminishes in strength, the spark plugs have probably frosted over. Pre-heat must be used before another start is attempted.

Pilots may opt to power on the battery 1 and 2 and avionics switches and obtain their IFR clearance and complete flight plan programming prior to engine start if clearance and/or taxi delays are anticipated. Limit ground operations without the engine running to preserve battery power for starting the engine.

### Procedure (Do-List)

1. External Power (if applicable) ..... CONNECT

If required, pilots may want to ensure power connection and brief assisting personnel on securing external power receptacle door.

• WARNING •

If airplane will be started using external power, keep all personnel and power unit cables well clear of the propeller rotation plane.

2. Brakes ..... HOLD

Parking brake may be used; however, constant pressure should be applied at all times using toe brakes.

3. Bat Master Switches ..... ON (check volts)

Voltage should read approximately 23-25 volts for battery starts.

4. Strobe Lights ..... ON

Turn strobe lights on prior to engine start to warn others of pending engine start. For night operations, pilot may instead consider the use of navigation lights to avoid distracting others.

5. Mixture ..... FULL RICH  
Mixture lever should be in the full rich position for normal engine start.
6. Power Lever ..... FULL FORWARD  
Power lever should be in the full forward position in order to prime the engine.
7. Fuel Pump ..... PRIME, then BOOST  
On the first start of the day, especially under cool ambient conditions, holding Fuel Pump switch to PRIME for 2 seconds will improve starting.
8. Propeller Area ..... CLEAR  
Visually clear the area around the propeller and ensure the area behind aircraft is clear and that no one is approaching the aircraft.
9. Power Lever ..... OPEN ¼ INCH  
Open power lever and maintain one hand on power lever.
10. Ignition Switch ..... START  
Hold key in Start position until positive engine start then release verifying key is in the BOTH position.

• Caution •

Limit cranking to intervals of 20 seconds with a 20 second cooling period between cranks. This will improve battery and contactor life.

11. Power Lever ..... RETARD (to maintain 1000 RPM)  
Adjust the power lever as necessary to maintain engine smoothness and engine speed at 1000 RPM.
12. Oil Pressure ..... CHECK

• Caution •

After starting engine, if the oil gauge does not begin to show pressure within 30 seconds in warm weather and about 60 seconds in very cool weather, shut down engine and investigate cause. Lack of oil pressure indicates loss of lubrication, which can cause severe engine damage.

13. Mixture (SR22TN/SR22T).....LEAN  
Lean the mixture for maximum RPM rise shortly after engine start and leave the mixture lean during taxi until the run up.  
It is acceptable to lean the SR20 and SR22 using the same procedure described above for high altitude operations or if spark plug fouling is suspected.
14. Alt Master Switches .....ON  
Turn on both alternator master switches after engine start.
- Caution •
- Alternators should be left OFF during engine start to avoid high electrical loads being placed on the alternators.
15. Avionics Power Switch .....ON  
Turn on avionics power switch and verify all avionics power up.
16. Engine Parameters ..... MONITOR  
Monitor all engine parameters to include manifold pressure, engine speed, oil pressure and temperature, EGTs, and CHTs. If any system displays an abnormal indication, engine shutdown should be considered and the problem investigated.
17. External Power (if applicable) ..... DISCONNECT  
Verify external power is removed and external power door secured by the assisting personnel. Consider reducing power to idle while external power is disconnected to minimize propeller blast. Carefully observe the process in case there is a need for engine shutdown.
18. Amp Meter/Indication ..... CHECK  
Check the amperage output of both alternators; both alternators should indicate a positive amperage. Check voltage of both batteries. Excessively high or low readings may indicate a problem and should be investigated.

## Common Errors

- Inadequate pre-heating during cold weather operations,
- Selection of the wrong starting technique,
- Over or under priming. Pilots are encouraged to monitor fuel flow during priming,

- Throttle mismanagement after engine start resulting in excessive RPMs,
- Fails to monitor oil pressure shortly after engine start,
- Fails to complete remaining engine start checklist items after the engine is started.



## Before Taxi

Complete the Before Taxi checklist as a flow and then reference the aircraft checklist to verify all items are complete. It is recommended to program the required navigation information and communication frequencies for the intended flight at this time. Navigation information should be entered into the flight plan via the Garmin Control Unit (GCU). Set primary airborne frequencies into COM 1 and necessary ground frequencies into COM 2. Set applicable VOR frequencies if necessary at this time.

Obtain airport weather information and call for taxi and or IFR clearance if applicable. Verify the waypoints entered into the flight plan match the IFR clearance obtained including applicable departure procedures.

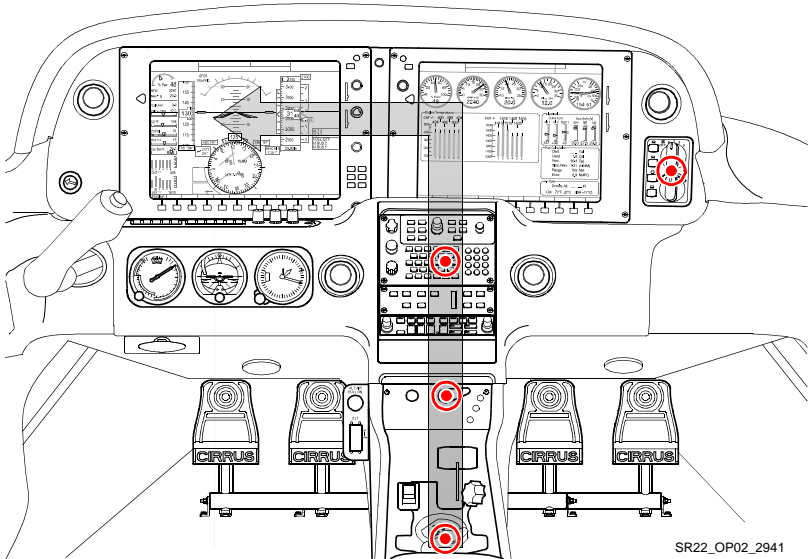

### Before Taxi Flow

#### Procedure (Flow Pattern)

1. Flaps ..... UP (0%)  
Visually verify flaps are in the 0% position and flap position light UP is illuminated.
2. Radios/Avionics ..... AS REQUIRED

Ensure all radios and avionics are programmed, navigation frequencies identified, courses set and with required waypoints or flight plans loaded.

3. Cabin Heat/Defrost ..... AS REQUIRED
4. Fuel Selector ..... SWITCH TANK  
Switch tank to ensure positive fuel flow from both fuel tanks.

### Avionics Configuration

- Audio Panel ..... Select COM AS REQUIRED  
Ensure desired communication are selected. Adjust intercom volume as required.
- Autopilot ..... Verify OFF  
Verify the autopilot is not engaged and yaw damper is off.
- GCU/MFD/PFD ..... SET COM and FPL AS REQUIRED  
Initialize the MFD and verify database currency. Construct flight plan as required and set applicable communication and navigation frequencies.
- MFD ..... CONFIGURE  
Adjust MAP page range to display Safe Taxi. Select Chartview to view the airport diagram if Safetaxi is not available for the airport.
- PFD ..... VERIFY and SET  
Verify PFD is fully aligned and select the traffic display on PFD inset display.

### Common Errors

- Neglects to setup communication and navigation information before taxi. Programming errors or delays typically occur when these tasks are completed at the end of the runway before takeoff,
- Fails to switch fuel tanks,
- Fails to reference the electronic checklist,
- Fails to deselect a monitored frequency on the audio panel after obtaining the necessary information, typically ATIS/AWOS.

## Taxi-Out

A cause of brake failure is the creation of excessive heat through improper braking practices. Riding the brakes while taxiing causes a continuous build up of energy which may lead to excessive heat. Excessive heat causes warped brake rotors, damaged or glazed linings, damaged o-rings, and vaporized brake fluid. To avoid brake failure, observe the following operating and maintenance practices:

- Directional control should be maintained with rudder deflection supplemented with brake pressure as required,
- Use only as much power (throttle) as is necessary to achieve forward movement. 1000 RPM is enough to maintain forward movement under normal conditions,
- Avoid unnecessary high speed taxiing. High speed taxiing will result in excessive demands on the brakes, increased brake wear, and the possibility of brake failure,
- Use the minimum necessary brake application to achieve directional control,
- Do not ride the brakes. Pilots should consciously remove pressure from the brakes while taxiing. Failure to do so results in excessive heat, premature brake wear, and increased possibility of brake failure,
- Refer to the Handling, Service and Maintenance section of the POH or the Maintenance manual for recommended maintenance and inspection intervals for brakes.

Maintain high levels of situational awareness during all movement on the airport surface to avoid a runway incursion accident. Minimize tasks such as reading checklists or folding maps while taxiing. Utilize the Safe Taxi airport diagram to aid in situational awareness.

### • WARNING •

Maximum continuous engine speed for taxiing is 1000 RPM on flat, smooth, hard surfaces. Power settings slightly above 1000 RPM are permissible to start motion, for turf, soft surfaces, and on inclines. Use minimum power to maintain taxi speed.

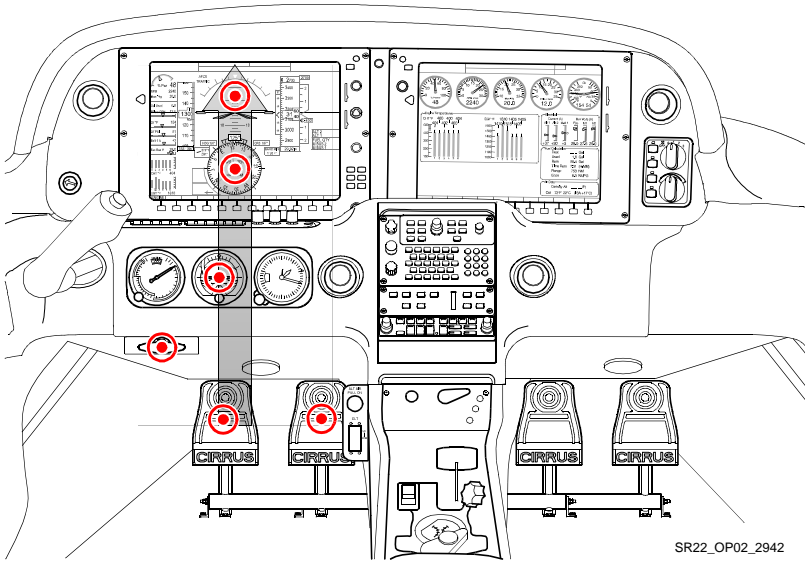

SR22\_OP02\_2942

### Taxi-Out Flow

#### Procedure (Flow Pattern)

1. Parking Brake.....DISENGAGE  
Manually depress parking brake and ensure completely down.
2. Brakes ..... CHECK  
Upon initial movement verify both brakes are functioning by applying pressure.
3. HSI Orientation ..... CHECK  
Visually check HSI alignment with magnetic compass.
4. Attitude Gyro ..... CHECK  
Verify gyro is erect and horizon bars are set level.
5. Turn Coordinator ..... CHECK  
During turns on the ground, verify the rate of turn indicator displays a turn in the direction of the turn and inclinometer displays a skid.

#### Common Errors

- Improper braking technique resulting in premature wear and possible fire,

- Fails to set and check all instrumentation during taxi or when the aircraft is moving and turning on the ground,
- Fails to reference the taxiing checklist,
- Fails to reference Safe Taxi for situational awareness during ground operations.

## Before Takeoff

Complete the Before Takeoff checklist as a do-list. Complete the checklist at an appropriate run up area prior to departure. The Before Takeoff checklist will ensure the aircraft is properly configured for takeoff and all engine and electrical indications are within parameters. Run-up items are included in this checklist. Verify engine oil temperature reaches a minimum of 100° F prior to applying run up power settings. Verify all engine and electrical indications are normal prior to departure.

During cold weather operations, the engine should be properly warmed before takeoff. In most cases this is accomplished when the oil temperature has reached at least 100° F. In warm or hot weather, precautions should be taken to avoid overheating during prolonged ground engine operation. Additionally, long periods of idling may cause fouled spark plugs.

### Procedure (Do-List)

1. Doors .....LATCHED  
Verify both top and bottom latch of each door is securely latched. Press firmly at each door latch position to determine the security of each door.
2. CAPS Handle ..... Verify Pin REMOVED  
Verify the CAPS pin is removed and stowed. Ensure cover placard is securely fastened.
3. Seat Belts and Shoulder Harness ..... SECURE  
Verify the security and placement of all seat belts and shoulder harnesses of each occupant. Also, verify all occupants are properly informed of seat belt requirements and operation.
4. Fuel Quantity ..... CONFIRM  
Confirm the fuel quantity is sufficient for the planned flight and fuel tank quantities are balanced.
5. Fuel Selector ..... FULLEST TANK  
Ensure the fuel selector is drawing fuel from the fullest tank.
6. Fuel Pump ..... AS REQUIRED  
SR20/SR22 - Fuel Pump On  
SR22TN/SR22T - Fuel Pump Low Boost

7. Mixture ..... AS REQUIRED  
SR22 - Set the mixture full rich for sea level departures. Set mixture control lever for maximum power on takeoff for altitudes higher than sea level. Reference the Max Power Fuel Flow placard or the top of the green arc of the fuel flow gauge for proper mixture setting. Power must be at full-throttle for placarded values to be accurate.  
SR20/SR22TN/SR22T - Set the mixture full rich for all altitudes.
8. Flaps ..... SET 50% & CHECK  
Select flaps to 50% and visually verify both flaps are in position prior to takeoff.
9. Transponder ..... SET  
Set assigned squawk code if one is given, otherwise, set the appropriate code.
10. Autopilot ..... CHECK  
Complete the autopilot test in accordance with the autopilot user guide.
11. Navigation Radios/GPS ..... Set for Takeoff  
Verify radio frequencies are set to include tower/departure frequencies. Check GPS flight plan for accuracy and correct initial waypoint.
12. Cabin Heat/Defrost ..... AS REQUIRED  
Set environmental controls as desired prior to takeoff.
13. Brakes ..... HOLD  
Firmly hold brakes. Set the parking brake if assistance is required.
14. Power Lever ..... 1700 RPM  
Increase power lever to 1700 RPM for engine run-up. Ensure oil temperature is at least 100° F prior to increasing power. Select the engine page for expanded engine and electrical information during the engine run-up.
15. Alternator ..... CHECK  
Alternator will be checked by placing greater electrical loads and turning on additional equipment below.
  - a. Pitot Heat ..... ON
  - b. Navigation Lights ..... ON

- c. Landing Light ..... ON
  - d. Annunciator Lights ..... Verify OFF
- Verify that no electrical CAS messages appear on the PFD and that positive amps are indicated.
- 16. Voltage ..... CHECK  
Verify voltage outputs for both main buses and the essential bus are in the green arcs.
  - 17. Pitot Heat ..... AS REQUIRED  
Pitot heat should be turned ON for flight into IMC, flight into visible moisture, or whenever ambient temperatures are 5° C or less to reduce the possibility of pitot tube icing.
  - 18. Navigation Lights ..... AS REQUIRED  
Select navigation lights ON for night operations.
  - 19. Landing Light ..... AS REQUIRED  
Select landing light ON. It is recommended to leave the landing light on while within 10NM of the departure airport.
  - 20. Magnetos ..... CHECK LEFT and RIGHT
    - a. Ignition Switch ..... R, note RPM, then BOTH
    - b. Ignition Switch ..... L, note RPM, then BOTHRPM drop must not exceed 150 RPM for either magneto. RPM differential must not exceed 75 RPM between magnetos. If there is a doubt concerning operation of the ignition system, RPM checks at higher engine speeds will usually confirm whether a deficiency exists. An absence of RPM drop may indicate faulty grounding of one side of the ignition system or magneto timing set in advance of the specified setting.
  - 21. Engine Parameters ..... CHECK  
Visually verify all engine parameters are in acceptable ranges. Check Oil pressure and temperature, RPM, manifold pressure, EGT and CHT.
  - 22. Power Lever ..... 1000 RPM
  - 23. Flight Instruments, HSI and Altimeter ..... CHECK and SET  
Set all flight instruments for initial course and altitude. Verify the HSI displays proper course and heading when checked with



magnetic compass. Ensure local altimeter has been set and is within 75 feet of field elevation.

24. Flight Controls..... FREE & CORRECT  
Check for full range of motion of the control yoke and that control surface deflection corresponds to yoke deflection.
25. Trim ..... SET for Takeoff  
Set electric trim in the takeoff position as displayed on control yoke arm.
26. Autopilot..... DISCONNECT  
Ensure PFD heading and altitude bugs are set and the autopilot is disconnected.  
  
GFC 700 - Press the go-around button on the throttle to engage the Flight Director in Takeoff (TO) mode. Set the HDG and ALT bug for the assigned initial heading and altitude.

### **Icing Conditions Anticipated after Takeoff (FIKI):**

1. ICE PROTECT System Switch .....ON
2. ICE PROTECT Mode Switch ..... NORM/HIGH  
HIGH should be selected initially to ensure critical lifting surfaces remain clear of ice during takeoff and initial climb. Once in enroute climb and ice buildup on unprotected surfaces is negligible, the pilot may select NORM. If rate of ice buildup on protected surfaces is unacceptable, select HIGH or MAX as appropriate.
3. PITOT HEAT Switch.....ON
4. Cabin Heat ..... Hot
5. Windshield Defrost.....ON  
Hot windshield defrost should be used to reduce the possibility of ice forming on the windshield.
6. Ice-Inspection Lights ..... As Required  
Ice inspection lights will illuminate the leading edges of the wings and horizontal stabilizer in order to monitor ice accumulation and confirm fluid flow at night.

### **Common Errors**

- Fails to complete checklist items in their entirety,

- Intentionally skips items in the checklist but neglects to re-reference the checklist and complete the task before departure,
- Fails to adhere to FIKI pitot heat ground operating limitations,
- Fails to recognize an unlatched pilot or passenger door during the engine run-up.

## Takeoff Briefing

Reference the Takeoff checklist prior to departure. Complete a takeoff briefing to review the critical items prior to takeoff. A takeoff briefing allows the pilot to review the takeoff procedure and determine the actions necessary in the event of abnormal/emergency conditions during the takeoff roll and initial climb. At a minimum, a takeoff briefing should include the following items:

- Type of procedure used (normal, short, or soft),
- Takeoff distance required / runway distance available,
- $V_R$  and initial climb speed,
- Abnormality / engine failure before  $V_R$ ,
- Abnormality / engine failure after  $V_R$ ,
- CAPS strategy in the event of a loss of power during climbout considering altitude.

### Sample Takeoff Briefing

This will be a \_\_\_\_\_ (normal, short, soft) takeoff from runway \_\_\_\_\_ with a takeoff distance of \_\_\_\_\_ feet and \_\_\_\_\_ feet of runway available. Rotation speed is \_\_\_\_\_ KIAS. Initial heading after takeoff is \_\_\_\_\_ degrees to an altitude of \_\_\_\_\_ feet. Abort the takeoff for any engine failures/abnormalities prior to rotation. If the engine fails after rotation I will \_\_\_\_\_ (determine if CAPS is an option).

### CAPS Takeoff Recommendation

Follow these recommendations in the event of a total loss of engine power during the initial climb out considering the aircraft's altitude.

| Height Above Ground Level (AGL) | Recommended Response               |
|---------------------------------|------------------------------------|
| 0' - 500', (0' - 600' G5)       | Land straight ahead <sup>a</sup>   |
| 500' - 2000', (600' - 2000' G5) | CAPS immediately                   |
| 2000' or greater                | Troubleshoot, use CAPS as required |

a. Activate CAPS immediately if no other survivable alternative exists.

## Normal Takeoff

Use of the Flight Director in Takeoff (TO) mode is recommended if using the GFC 700 autopilot. Press the Go-around button on the throttle to engage the Flight Director in TO mode. The recommended flap setting for a normal takeoff is 50%. Align the aircraft on the runway centerline and smoothly apply full power in a 4 to 5 second continuous sweep. Slight brake pressure may be required for directional control early in the takeoff roll in some crosswind situations. Maintain directional control with rudder during the takeoff roll after sufficient rudder control is available. Check engine and airspeed indications early in the takeoff roll to ensure proper function. Discontinue the takeoff by reducing the power to idle and using brakes as necessary for any abnormal engine or airspeed indications, sluggish acceleration, or rough engine. At  $V_R$  smoothly apply back pressure to the control yoke sufficiently enough to rotate the aircraft. Pitch the aircraft for approximately  $7^\circ$  to intercept  $V_X$  or  $V_Y$  as appropriate. Maintain coordination with proper rudder input during the climb out.

### Procedure (Flow Pattern)

1. Brakes ..... RELEASE (Steer with Rudder)

Initially, a slight amount of differential braking may be required for directional control. As airspeed increases, both feet should be removed from toe brakes and directional control maintained with rudder inputs.

2. Power Lever ..... FULL FORWARD

Smoothly increase power lever full forward for maximum takeoff power. Discontinue takeoff if any rough or sluggish acceleration is noted. Do not confuse any detents for a full power setting. Engine speed at full power should be approximately:

- SR20/SR22/SR22TN - 2700 RPM,
- SR22T - 2500 RPM.

SR22TN/SR22T - During the first takeoff of the day, due to relatively low engine oil temperature, engine Manifold Pressure may exceed limits. This is acceptable, but if this occurs, pilots should smoothly reduce power slightly to bring MP back below red-line. As a technique, pilots can smoothly add power on takeoff until reaching red line, instead of full-forward. Verify that the power lever can be moved to full forward and remain within limits.

3. Engine Parameters ..... CHECK  
Monitor engine parameters during the takeoff roll. If any abnormal or questionable indications arise, abort the takeoff early in the takeoff roll.
4. Elevator Control ..... ROTATE Smoothly at  $V_R$   
As airspeed approaches  $V_R$ , smoothly and gradually apply back pressure to the control yoke to increase the angle of attack sufficiently enough to rotate the aircraft.
  - SR20 - 65 to 70 KIAS
  - SR22 - 70 to 73 KIAS
  - SR22 G5 - 73 to 76 KIAS
  - SR22T G5 - 77 to 83 KIAS
5. Flaps ..... UP  
Retract the flaps after the following conditions have been met. Slight back pressure may be required after flap retraction
  - SR20 - 85 KIAS,
  - SR22 - 80 KIAS,
  - SR22 G5 - 90 KIAS,
  - Positive rate of climb,
  - Clear of terrain and obstacles.
  - FIKI - Retract as soon as practical once conditions are met.

## Completion Standards

- Verifies sufficient runway length is available for departure,
- For IFR flights, becomes familiar with and follows departure procedure guidance,
- Selects and executes the proper takeoff procedure with the appropriate configuration,
- Briefs the takeoff as recommended in this section with emphasis on developing a plan to handle abnormalities before or after rotation including CAPS procedures,
- Adds power smoothly to full power (4 to 5 seconds from 0 - 100%) and verbally verifies engine indications, CAS messages, and airspeed are normal early in takeoff roll,

- Aborts the takeoff early in the takeoff roll and applies brakes as necessary for engine parameter exceedences, CAS messages, airspeed issues, or other safety of flight issues,
- Keeps the runway center line between the main landing gear wheels through takeoff roll, rotation, and initial climb,
- Rotates smoothly at the recommended rotation speed to a climb attitude that will intercept  $V_X$  or  $V_Y$  as desired,
- Retracts flaps as recommended and continues to pitch the aircraft for the recommended climb airspeed,
- Does not engage the autopilot before 400 feet AGL,
- Verbally announces "CAPS Available" at 500 feet AGL,
- Maintains runway alignment until 1/2 mile past the departure end of the runway unless otherwise directed by ATC.

### Common Errors

- Loses directional control due to inadequate rudder inputs,
- Fails to recognize an unlatched or improperly closed door,
- Fails to promptly add full power early in the takeoff roll,
- Over rotates and uses poor airspeed control during the initial climb,
- Fails to track over the extended runway centerline during initial climb,
- Uses brakes excessively during the takeoff roll,
- Fails to recognize an unsafe situation early in the takeoff roll and fails to abort the takeoff promptly.

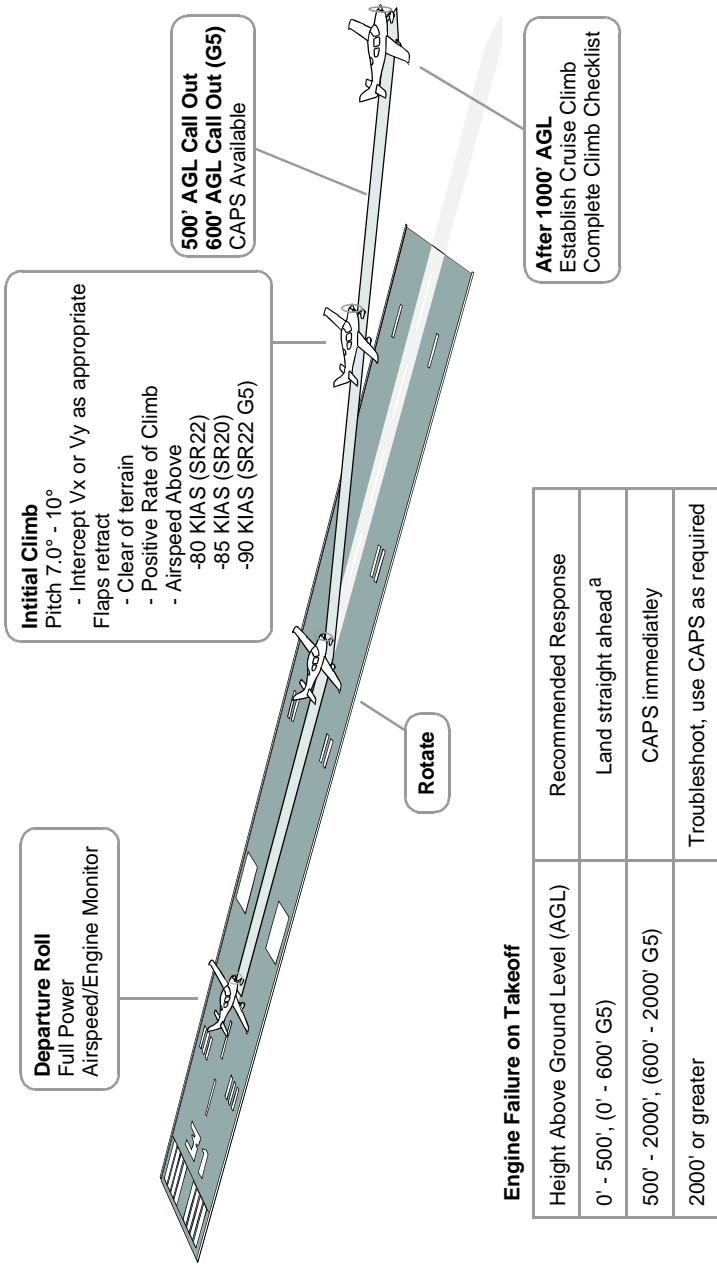

SR22\_OP02\_2662A

**Figure 3-1**  
**Takeoff Profile**

a. Activate CAPS immediately if no other survivable alternative exists.

## Short-Field Takeoff

Use the short-field technique to maximize takeoff performance and minimize takeoff ground roll. Set Flaps to 50% for a short-field takeoff. Align the aircraft on the runway centerline as close as possible to the end of the runway. Apply sufficient brake pressure and smoothly apply full power. Check engine indications and ensure full power before releasing the brakes. Steer with rudder only in order to minimize the ground roll distance. Rotate the aircraft at  $V_R$  smoothly and pitch for the obstacle clearance speed if an obstacle is present. Pitch for  $V_Y$  after clearing obstacles.

1. Flaps .....50%  
Set flaps to 50% and visually verify both flaps are in position prior to takeoff.
2. Brakes ..... HOLD  
Hold brakes firmly, do not allow the aircraft to roll.
3. Power Lever ..... FULL FORWARD  
Smoothly increase power lever full forward for maximum takeoff power. Discontinue takeoff if any rough or sluggish acceleration is noted. Do not confuse any detents for a full power setting. Engine speed at full power should be approximately:
  - SR20/SR22/SR22TN - 2700 RPM,
  - SR22T - 2500 RPM.
4. Mixture ..... SET  
SR22 - Set the mixture full rich for sea-level departures. Set mixture control lever for maximum power on takeoff for altitudes higher than sea level. Reference the Max Power Fuel Flow placard or the top of the green arc of the fuel flow gauge for proper mixture setting. Power must be at full-throttle for placarded values to be accurate.  
SR20/SR22TN/SR22T - Set the mixture to full rich for all altitudes.
5. Engine Parameters ..... CHECK  
Check all engine parameters prior to releasing the brakes. If any abnormal or questionable indications arise, consider aborting takeoff.
6. Brakes ..... RELEASE



Release the brakes and steer with rudder only. Sufficient rudder control should be available with full power.

7. Elevator Control ..... ROTATE Smoothly at  $V_R$

As airspeed approaches  $V_R$ , smoothly and gradually apply back pressure to the control yoke to increase the angle of attack sufficient for rotation.

- SR20 - 65 KIAS
- SR22 - 70 KIAS
- SR22 G5 - 73 KIAS
- SR22T G5 - 77 KIAS

8. Airspeed at Obstacle ..... Obstacle Clearance Speed

Maintain the obstacle clearance speed with flaps at 50% until safely clear of all obstacles.

- SR20 - 77 KIAS
- SR22 - 78 KIAS
- SR22 G5 - 84 KIAS
- SR22T G5 - 85 KIAS

### Completion Standards

- Properly executes applicable completion standards for a normal takeoff,
- Uses maximum available runway,
- Applies full power while holding sufficient brake pressure to keep the aircraft stationary until,
- Rotates promptly at the desired airspeed to proper pitch attitude to intercept  $V_x$  or  $V_y$  as necessary,
- Maintains coordination throughout initial climb.

### Common Errors

- Fails to use all available runway,
- Fails to hold sufficient brake pressure to keep the aircraft stationary during power addition,
- Over rotates the aircraft, causing a possible stall condition,
- Fails to apply adequate rudder inputs to maintain coordination,

- Prematurely retracts flaps, causing excessive sink rates.

## Soft-Field Takeoff

Soft or rough field takeoffs are executed using 50% flaps. Add 20% to the takeoff ground roll distance for dry grass runways and 30% for wet grass. Ensure the quality of the runway is adequate to support the aircraft. Avoid runways with long grass, soggy soil and large ruts or holes. Higher power settings will be required to taxi on grass surfaces. Hold full back pressure on the control yoke while taxiing and during the initial takeoff roll to reduce the pressure on the nose wheel. Reduce the back pressure slightly once the nose wheel lifts off the ground. Hold the aircraft in a nose up attitude until the aircraft becomes airborne. Once airborne reduce back pressure as necessary to remain in ground effect or within 20 feet of the surface. Accelerate the aircraft to  $V_X$  (for obstacles clearance) or  $V_Y$  before climbing out of ground effect.

### Completion Standards

- Properly executes applicable completion standards for a normal takeoff,
- Verifies the runway condition supports safe takeoff by taxiing over the runway prior to depart,
- Holds the elevator full aft during taxi and takeoff roll when sufficient elevator authority exists,
- Holds the aircraft at a high angle (approx 5 to 7.5 degrees) when sufficient airflow is available over the elevator,
- Relaxes back pressure during the takeoff roll and does not over rotate the aircraft,
- Reduces pitch when the aircraft becomes airborne to maintain in ground effect until  $V_X$  or  $V_Y$  is reached,
- Climbs out at  $V_X$  or  $V_Y$  as necessary.

### Common Errors

- Fails to apply sufficient back pressure during taxi or takeoff roll,
- Over rotates the aircraft during the takeoff roll or at rotation,
- Fails to apply sufficient rudder input to maintain directional control,
- Climbs out of ground effect too quickly.

## Crosswind Takeoff Technique

Partially deflect the ailerons into the wind during a crosswind takeoff. Maintain directional control with proper rudder input. Allow the aircraft to accelerate to a speed slightly higher than  $V_R$  prior to rotation. Lift the aircraft off the ground slightly quicker than with a normal takeoff. Shortly after rotation, crab the aircraft into the wind to track the aircraft along the runway centerline. Maintain coordination during climb with proper rudder input.

### Completion Standards

- Properly executes applicable completion standards for a normal takeoff,
- Recognizes the need for the crosswind technique,
- Applies aileron input into the crosswind and uses rudder to maintain runway alignment during the takeoff roll and rotation,
- Reduces the amount of aileron deflection as the aircraft accelerates and aileron control effectiveness increases,
- Establishes coordinated flight and a wind correction angle shortly after takeoff and tracks over the runway centerline during initial climb.

### Common Errors

- Fails to identify a crosswind situation,
- Fails to apply correct aileron inputs resulting in drift or side loads on the landing gear,
- Fails to establish a wind correction angle after rotation and allows the aircraft to drift away from the runway center line,
- Fails to resume coordinated flight after rotation resulting in a cross-control situation,

## Enroute Climb

Complete the Climb checklist as a flow when time and workload permit. Once clear of obstacles and terrain, normal climbs are performed flaps UP (0%) and full power at speeds 5 to 10 knots higher than best rate-of-climb speeds. These higher speeds give the best combination of performance, visibility and engine cooling. When desired and clear of obstacles, transition to cruise climb speed for increased engine cooling, visibility, and passenger comfort.

For maximum rate of climb, use the best rate-of-climb speeds shown in the rate-of-climb chart in Section 5 of the POH. If an obstruction dictates the use of a steep climb angle, the best angle-of-climb speed should be used. Climbs at speeds lower than the best rate-of-climb speed should be of short durations to avoid engine cooling problems.

For operation in noise sensitive areas when obstacle and terrain clearance is not an issue, the following procedures are recommended. Upon reaching 1000' AGL reduce power to 2500 RPM with maximum manifold pressure. Adjust pitch to maintain the desired climb airspeed. Resume full power climb upon reaching 3000' AGL and adjust mixture accordingly.

• Caution •

Use caution when engaging the autopilot at low altitude due to the increased workload of programming the autopilot and potential for human errors. Pilots should hand fly the aircraft to a safe altitude and engage the autopilot if desired when time and workload permit.

| Climb Speeds (KIAS)             | SR20        | SR22        | SR22<br>G5  | SR22TN<br>SR22T | SR22T<br>G5 |
|---------------------------------|-------------|-------------|-------------|-----------------|-------------|
| Cruise Climb                    | 100-<br>110 | 110-<br>120 | 110-<br>120 | 120-130         | 120-<br>130 |
| Best Rate ( $V_Y$ ), Sea Level  | 96          | 101         | 108         | 101             | 103         |
| Best Rate ( $V_Y$ ), 10,000 ft  | 92          | 96          | 99          | 101             | 102         |
| Best Angle ( $V_X$ ), Sea Level | 83          | 79          | 88          | 84              | 88          |
| Best Angle ( $V_X$ ), 10,000 ft | 87          | 83          | 88          | 84              | 88          |

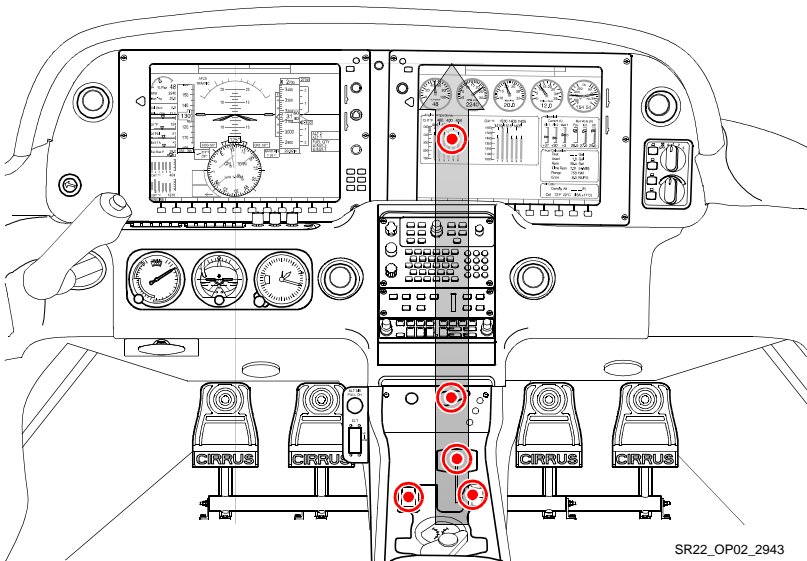

### Enroute Climb Flow

#### Procedure (Flow Pattern)

1. Climb Power ..... SET  
 Set climb power considering noise abatement procedures. Normal climbs are made with full power.
2. Flaps ..... Verify UP  
 Verify flaps have been retracted to 0%. If not, verify below  $V_{FE}$  and ensure the following criteria has been met before retracting the flaps:
  - SR20 - 85 KIAS,
  - SR22 - 80 KIAS,
  - SR22 G5 - 90 KIAS,
  - Positive rate of climb,
  - Clear of terrain and obstacles.
3. Mixture ..... AS REQUIRED  
 Set power, mixture, and airspeed per table.
4. Fuel Pump ..... As Required  
 SR20 - OFF

SR22 - BOOST

SR22TN/SR22T - LOW BOOST

Fuel boost should be left on during takeoff and for climb as required for vapor suppression with hot or warm fuel.

| Climb Settings |                    | Power Lever  | Mixture / Fuel Flow | Airspeed |
|----------------|--------------------|--------------|---------------------|----------|
| SR20           |                    | Full Forward | Full Rich           | 100-110  |
| SR22           |                    | Full Forward | Top of Green Arc    | 110-120  |
| SR22TN         | Full Power Climb   | Full Forward | Full Rich           | 120-130  |
|                | Lean of Peak Climb | Full Forward | Cyan Target or Less | 130      |
| SR22T          | Full Power Climb   | Full Forward | Within Green Arc    | 120-130  |
|                | Lean of Peak Climb | 30.5" MP     | Cyan Target or Less | 130      |

5. Engine Parameters ..... CHECK

Check all engine parameters for any abnormal indications that may indicate impending engine problems.

- Fuel Flow - Monitor per Climb Settings table above
- Cylinder Head Temperatures - Adjust fuel flow and/or airspeed to keep CHTs below:
  - SR22T - 420° F,
  - SR22TN - 380° F.

6. Oxygen ..... AS REQUIRED

- a. Oxygen Masks/Cannulas ..... DON
- b. Oxygen System ..... ON
- c. Flow Rate ..... ADJUST for planned cruise altitude
- d. Flowmeters and Quantity ..... MONITOR

For optimal protection, pilots are encouraged to use supplemental oxygen above 10,000 feet during the day and above 5,000 feet at night.

Cannulas are not approved above 18,000 feet MSL because cannulas fail to deliver adequate levels of oxygen. Pilots must use a mask that is certified above 18,000 feet MSL when operating above FL180.

If using a pulse oximeter, adjust flow rate to keep oxygen saturation above 90%. Pilots are encouraged to use pulse oximeter and check saturation levels every 10 to 15 minutes.

## Avionics Configuration

- Autopilot - Engage modes as desired above 400 feet AGL when time and workload permit,
- MFD - Complete Climb Checklist, monitor map for situational awareness,
- PFD - Monitor aircraft flight parameters and system status.

## Completion Standards

- Maintains positive aircraft control,
- Retracts the flaps when climbing, clear of obstacles, and at the prescribed airspeed,
- Maintains desired airspeed within +10/-5 KIAS,
- Abides by local noise abatement procedures if applicable,
- Follows instrument departure procedures if applicable,
- Follows ATC instructions and clearances if applicable,
- Completes the Climb checklist as a flow and references the checklist when workload permits,
- Manages engine temperatures through airspeed/pitch control, proper power and mixture settings as recommended by the AFM,
- At pilot's discretion, uses the autopilot to reduce workload,
- Uses proper scanning techniques and Traffic Alert System for collision avoidance,
- Uses supplemental oxygen at the appropriate time during the climb,
- Maintains appropriate cloud clearances during VMC climbs,
- Operates FIKI system properly when flying through icing conditions during departure.



## Common Errors

- Inability to maintain desired airspeed while hand flying,
- Over dependence on the autopilot for controlled flight,
- Engaging the autopilot before 400 feet AGL,
- Fails to engage the proper mode of the autopilot,
- Fails to complete Climb checklist items,
- Fails to divide attention and look outside during VFR climbs,
- Fails to become familiar with, program, or follow applicable departure procedures,
- Neglects to monitor engine parameters during climb,
- Fails to set mixture control as required during climb,
- Fails to abide by sterile cockpit rules during climbout,
- Fails to monitor for icing conditions.

## Cruise

Complete the Cruise checklist as a flow when time and workload permit. Allow the aircraft to accelerate to cruise speeds before setting the desired cruise power setting. Ensure adequate fuel reserves remain for the intended destination. Normal cruise power settings are between 55% - 85% power with mixture set for best power or best economy. Turbo aircraft will always cruise at best economy.

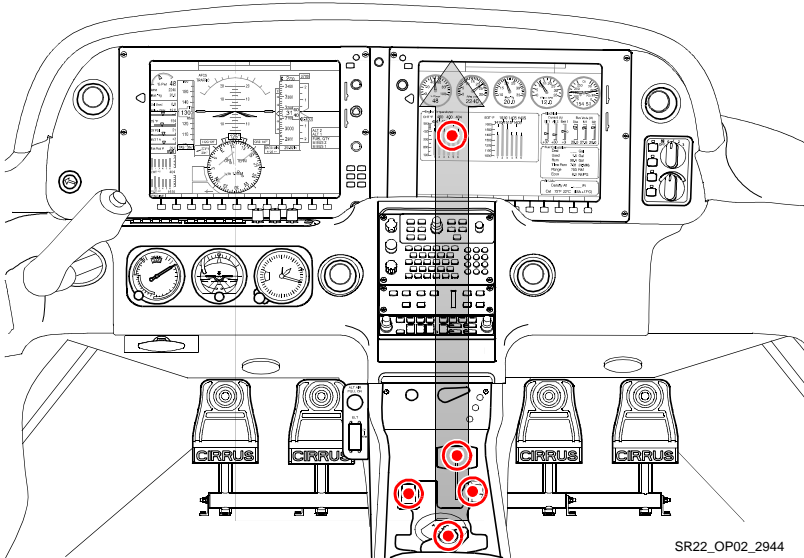

### Cruise Flow

## Engine Break-In

For engine break-in of normally-aspirated engines, cruise at a minimum of 75% best power, rich of peak EGT, until the engine has been operated for at least 25 hours or until oil consumption stabilizes. Turbo aircraft may be operated at best economy, lean of peak EGT, with a power setting greater than 75% during engine break-in. Operation at higher power will ensure proper seating of the rings, and is applicable to new engines, and engines in service following cylinder replacement or top overhaul of one or more cylinders.

## Procedure (Flow Pattern)

1. Fuel Pump..... OFF / AS REQUIRED

The Fuel Pump may be used for vapor suppression in cruise. Vapor lock issues may be recognized by fluctuating EGTs, CHTs and fuel flows, and rough engine operation. Select BOOST or HIGH BOOST as appropriate if vapor lock is suspected.

2. Power Lever ..... SET

Allow the aircraft to accelerate to cruise speeds before setting cruise power. Select the desired percent power considering range, endurance, and desired performance for the intended flight.

SR22TN - Reduce the power lever to 2500 RPM with maximum MP. If a lower power setting is desired to increase range/endurance, reduce the throttle to the desired percent power.

SR22T - Reduce power lever to 30.5" MP or less.

3. Mixture .....LEAN as required

SR20/SR22 - Use the Lean Assist feature on the MFD Engine page to set the mixture control for Best Power or Best Economy.

| Mixture Description | Exhaust Gas Temperature |
|---------------------|-------------------------|
| Best Power          | 75° F Rich of Peak EGT  |
| Best Economy        | 50° F Lean of Peak EGT  |

SR22TN/SR22T - Set the fuel flow to the cyan target or less.

4. Engine Parameters ..... MONITOR

Monitor all engine parameters for any abnormal indications that may indicate impending engine problems.

- SR22TN/SR22T - Lean Mixture to keep all CHTs below 420° F (SR22T) or 380° F (SR22TN). As an approximation, a 0.5 GPH reduction in fuel flow will reduce CHTs by 15° F.

5. Fuel Flow and Balance ..... MONITOR

Check fuel flow gauge and ensure fuel balance is within 7.5 gallons (SR20), 10 gallons (SR22).

Fuel BOOST must be used for switching from one tank to another. Failure to activate the Fuel Pump before transfer could result in delayed restart if the engine should quit due to fuel starvation.

## Icing Conditions (FIKI)

Even with an aircraft that is certified to operate in known icing conditions, prolonged flight in icing conditions should be avoided. Pilots should use good pre-flight planning to choose a route and altitude that will minimize time in icing conditions. If this is not possible, consider delaying or cancelling the flight. Pilots should always have an escape option in case of a system malfunction or severe ice encounter. This escape could be above or below the cloud layer or below the freezing level. Note that in some conditions the freezing level may be at the surface or below the MEA.

Pilots may generally escape the worst icing conditions in stratus clouds by making an altitude change of more than 3000 ft. While flying through cumulus clouds, altitude changes may not be effective and lateral deviations may be necessary to escape the worst icing conditions.

During icing encounters in cruise, increase engine power to maintain cruise speed as ice accumulates on the unprotected areas and causes the aircraft to slow down. Sacrifice altitude if necessary in order to maintain safe flying speed.

The autopilot may be used in icing conditions. However, every 30 minutes the autopilot should be disconnected to detect any out-of-trim conditions caused by ice buildup. If significant out-of-trim or other anomalous conditions are detected, the autopilot should remain off for the remainder of the icing encounter. When disconnecting the autopilot with ice accretions on the airplane, the pilot should be alert for out-of-trim forces.

### Ice Formation Determination

Typically, a leading edge with a small radius will collect ice more quickly than a leading edge with a large radius. To help monitor possible ice accumulation, a thin metal tab is attached to the outboard end of the right-hand and left-hand stall strips. In some icing conditions this tab may be the first place that airframe ice accretion is noticeable. Additionally, refer to other areas of the aircraft, such as the horizontal tail and lower windscreen, to aid in determining if ice is accreting to the aircraft.

• Caution •

Ice accumulations on protected areas are abnormal.

## De-Icing Procedures

1. Pitot Heat ..... Verify ON
2. Ice Protect System Switch ..... ON
3. Ice Protect Mode Switch ..... AS REQUIRED  
Select NORM or HIGH as conditions dictate.  
If icing conditions are inadvertently encountered, press MAX to initially dissipate ice accumulation, then select NORM or HIGH as required by ice accumulation.
4. WIND SHLD Push-Button ..... PRESS As Required  
Use the windshield ice protection when residual fluid that is slung off of the propeller will not keep the windshield free of ice. Due to the temporary reduction in visibility, do not use the windshield sprayer within 30 seconds prior to landing.
5. Airspeed ..... Maintain 95-177 KIAS and less than 204 KTAS  
Maintaining airspeed within this range will ensure proper pressure distribution over the wings and effective anti-ice system operation. Adjust final approach airspeed to 95 KIAS with 50% flaps when landing with ice adhering to the aircraft.
6. Flaps ..... UP  
Keep flaps in the up position until required for landing. Limit flap extension for landing to 50%.
7. Ice Inspection Lights ..... AS REQUIRED  
Ice inspection lights will illuminate the leading edges of the wings and horizontal stabilizer in order to monitor ice accumulation and confirm fluid flow at night.
8. Cabin Heat ..... HOT
9. Windshield Defrost ..... ON  
Windshield defrost set to hot will help to keep the windshield free of ice.
10. Anti-ice Fluid Quantity ..... MONITOR  
Ensure adequate quantity to complete flight.
11. Ice Accumulation ..... MONITOR  
If ice accretion rate is higher than desired or ice is not shedding, select a higher mode of operation. If ice accretions do not shed,

select PUMP BKUP and perform the Anti-Ice System Failure Checklist. Exit icing conditions immediately if ice cannot be shed.

## Avionics Configuration

- Autopilot - Ensure correct modes are engaged if desired,
- GCU/Flight Plan - ensure proper navigation is set,
- MFD - Use Lean Assist to lean the mixture. Complete the Cruise Checklist,
- PFD - Monitor aircraft flight parameters and system status.

## Completion Standards

- Allows the aircraft to accelerate before setting cruise power,
- Adheres to procedures described in the AFM for setting cruise power and mixture controls,
- Completes Cruise checklist,
- Monitors engine parameters and manages accordingly,
- Establishes the aircraft on the intended course and altitude,
- Ensures adequate fuel reserves will be available when reaching the destination, monitors fuel status throughout the flight,
- Monitors enroute and destination weather periodically,
- Plans arrival and descent before descent is required,
- Keeps the aircraft within fuel balance limitations,
- Monitors the physical state of passengers during cruise, especially important for flights above 10,000 feet MSL,
- Identifies situations that require an altitude or route change, such as: weather, airspace, and traffic,
- Maintains altitude +/-200 feet and headings +/-15 degrees.

## Common Errors

- Exhibits tendencies toward complacency, and fails to monitor flight status, passengers, pilot fatigue, and weather.
- Forgets to plan descents and prepare for arrival,
- Fails to recognize an inadequate fuel quantity situation or exceed the maximum fuel imbalance,
- Fails to set the mixture throughout the descent properly.

## Descent

Descents should be planned during cruise considering the amount of altitude to lose, distance and time to destination, ATC restrictions, obstacle/terrain clearance, desired rate of descent, and engine care. Use the vertical navigation function of the GPS to assist descent planning. To manage workload, complete the descent checklist at the top of descent or at least 20 minutes from the destination. Set appropriate frequencies and review weather to determine the active runway. Verify GPS units are programmed as desired for the arrival and approach into the airport.

During descent, power should be used to manage airspeed and maintain engine temperatures as desired. Maintain airspeed within the green arc if turbulence is expected or encountered during the descent. Use caution and avoid excessive maneuvering when airspeed is within the yellow arc during the descent. Complete the Descent checklist as a flow when time and workload permit upon initial descent to land. Reference the checklist to verify all items are complete once the flow has been completed.

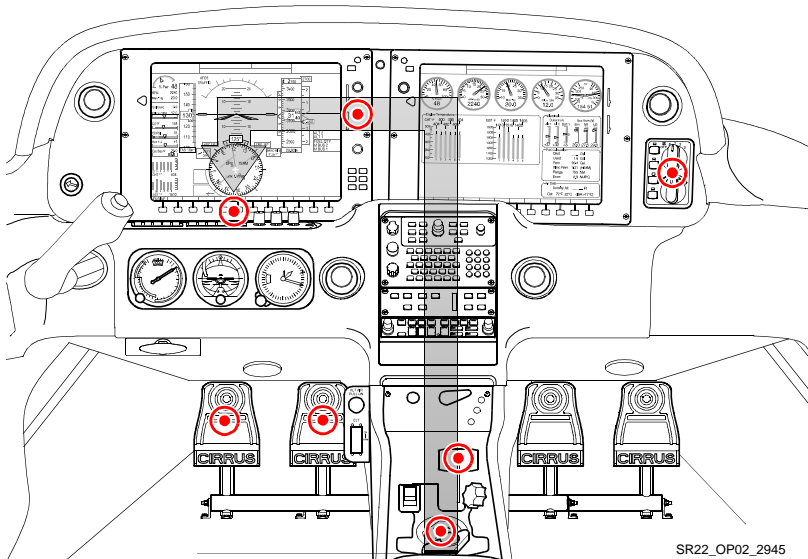

SR22\_OP02\_2945

### Descent Flow

## Procedure (Flow Pattern)

1. Oxygen..... AS REQUIRED
2. Altimeter..... SET  
Verify the proper altimeter setting has been set into the PFD and in the standby altimeter.
3. Cabin Heat/Defrost ..... AS REQUIRED
4. Landing Light ..... ON  
The landing light should be selected on for visibility to others at the top of the descent or within 10NM from the destination. If in IMC, consider leaving off to reduce light reflection in the cabin.
5. Fuel System ..... CHECK  
Ensure fuel is balanced and selected to the fullest tank.
6. Mixture ..... AS REQUIRED  
SR20 - It is not necessary to adjust the mixture during descent.  
SR22 - Consider altitude when setting mixture for descent. Full mixture settings at high altitudes may lead to engine roughness or flooding resulting in engine loss.  
SR22TN/SR22T - Set the fuel flow to the cyan target or less.
7. Brake Pressure ..... CHECK  
Apply pressure to each toe brake and ensure resistance is felt. A soft or mushy feeling in the brakes could indicate a brake failure.

## Rapid Descent (SR22TN/SR22T)

1. Power Lever ..... REDUCE MP to 18-20" Hg  
Pitch the aircraft to the top of the green arc on the airspeed indicator,
2. Mixture ..... Maintain CHTs above 240° F

## Avionics Configuration

- Autopilot - Engage the modes on autopilot for descent as desired,
- GCU/Flight Plan - Verify that the correct navigation information is set,
- MFD - Complete the Descent checklist, monitor the map for situational awareness,



- PFD - Set Altitude Bug as appropriate for the descent. Monitor the aircraft flight parameters.

## Completion Standards

- Starts descent at the calculated top of descent and at the calculated descent rate,
- Maintains positive aircraft control with emphasis on airspeed and vertical descent rate,
- Adheres to ATC and airspace restrictions throughout the descent,
- Maintains airspeed below  $V_{NO}$  while descending in turbulent conditions or if turbulence is expected in the descent,
- Recognizes a steep descent, usually due to ATC restrictions, and manages airspeed and descent rates accordingly,
- Monitors for icing conditions during descents in IMC,
- Uses the correct modes of the autopilot to assist in workload management while preparing for arrival/landing,
- Completes the Descent checklist as flow pattern and references the checklist when workload permits.

## Common Errors

- Fails to start the descent at the appropriate time using the necessary descent rate,
- Fails to consider passenger comfort when selecting descent rates and/or airspeed,
- Neglects to complete the Descent checklist items in a timely manner,
- Fails to complete airport arrival tasks and planning,
- Fails to slow to a speed that allows the pilot to perform a stabilized approach in a timely manner,
- Controls or reduces power too aggressively or abruptly,
- Allows airspeed to decay unknowingly during level-off with low power settings,
- Does not trim the aircraft for changes in airspeed throughout the descent.

## Before Landing and Traffic Pattern

Complete the Before Landing checklist as a flow prior to entering the traffic pattern when time and workload permit. Slow the aircraft early enough to allow for an easy transition into the traffic flow and enough time to ensure the aircraft is configured for landing. The following profile describes a normal traffic pattern. Pilots should use this profile as a guide when entering the traffic pattern on the downwind leg and modify as appropriate for base entry or straight-in approaches.

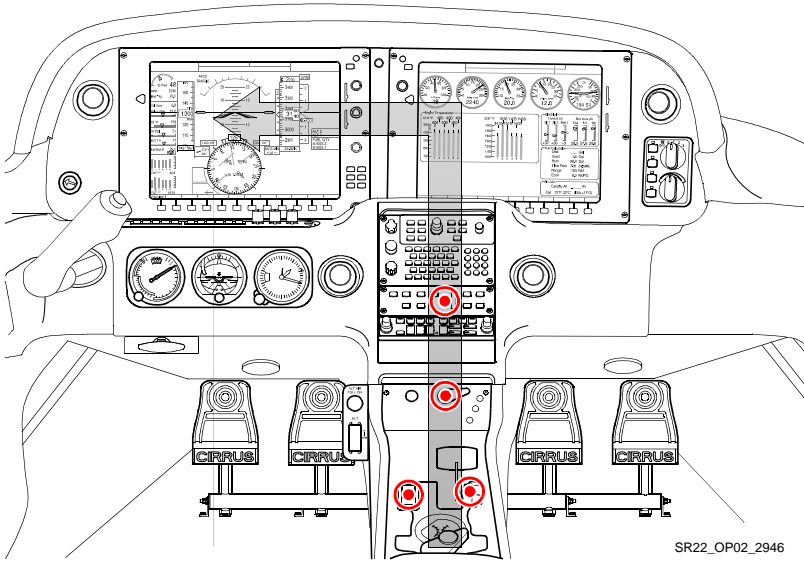

### Before Landing / Traffic Pattern Flow

#### Procedure (Flow Pattern)

1. Seat Belt and Shoulder Harness..... Secure  
Ensure the seat belt and shoulder harness is secure for all occupants in the aircraft.
2. Fuel Pump..... BOOST
3. Mixture ..... AS REQUIRED  
SR20 - Mixture full rich for all altitudes.  
SR22 - Mixture as required for altitude. Reference the green arc on the fuel flow gauge or the Max Power Fuel Flow placard for mixture setting. Avoid rich mixture settings at high elevations.

SR22TN/SR22T - Mixture full rich for all altitudes.

The mixture should be placed in the landing position prior to entering the traffic pattern or prior to the FAF on an instrument approach.

4. Flaps ..... AS REQUIRED

Reference the Traffic Pattern Profile or Approach Profile for information on the appropriate use of flaps

5. Autopilot ..... AS REQUIRED

It is recommended to disconnect the autopilot prior to entering the traffic pattern. Ensure yaw damper is off prior to landing.

### Avionics Configuration

- Autopilot - Disengage the autopilot prior to entering the traffic pattern, verify the yaw damper is disconnected,
- MFD - Complete the Before Landing checklist, monitor Map for situational awareness,
- PFD - Monitor aircraft flight parameters.

SR22\_OP02\_2666B

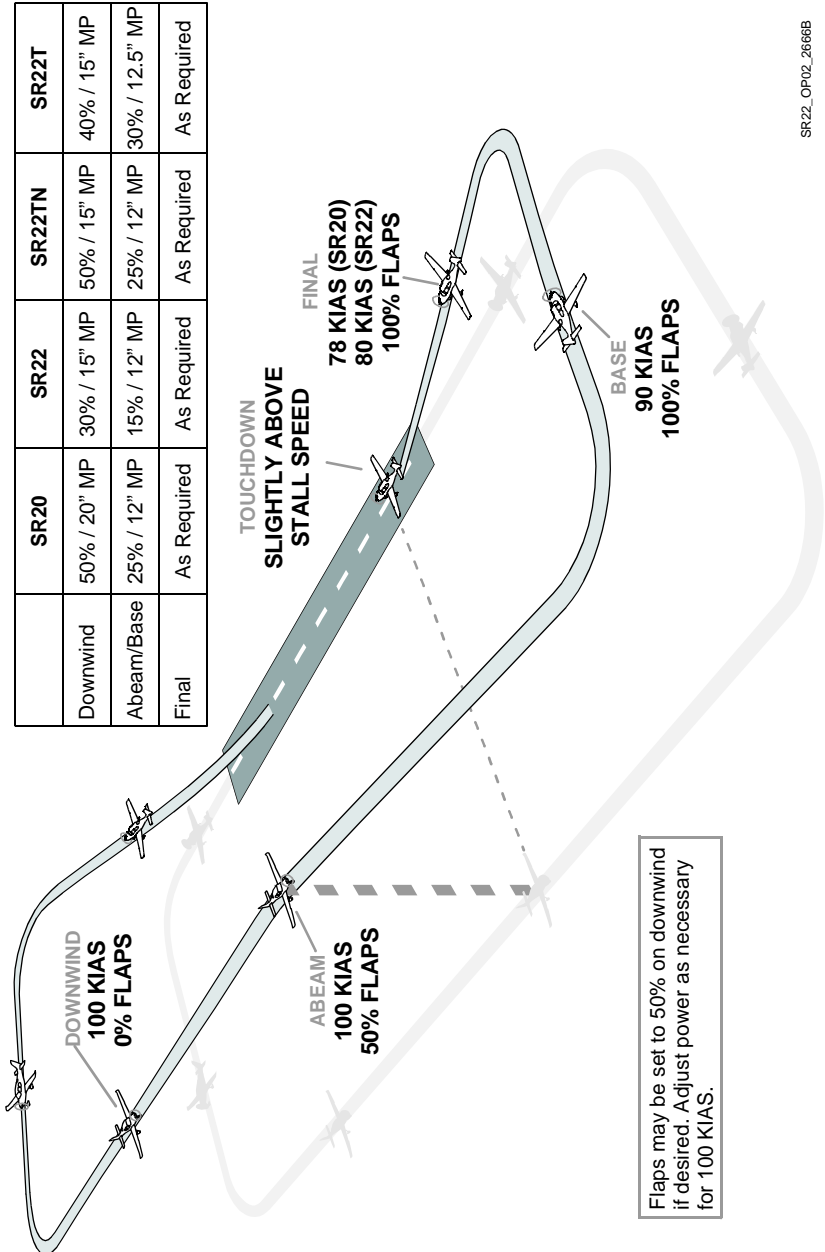

Figure 3-2  
 Traffic Pattern Profile

## Completion Standards

- Slows the aircraft to recommended downwind speed before mid-field downwind,
- Completes Before Landing checklist before entering the traffic pattern,
- Properly communicates with ATC or other traffic in the local area,
- Enters the traffic pattern complying with local procedures, ATC clearances, and prescribed traffic pattern procedures,
- Maintains traffic pattern altitude on downwind +/-100 feet, airspeed +/-10 KIAS,
- Establishes a controlled descent, manages aircraft configuration and airspeed as described above with airspeed +/-5 KIAS
- Maintains proper spacing from other aircraft in the traffic pattern,
- Disconnects the autopilot before entering into the traffic pattern.

## Common Errors

- Carries excessive speed on the downwind leg due to improper planning and power management,
- Enters downwind leg above traffic pattern altitude due to improper descent planning and/or power management,
- Fails to follow standardized power and aircraft configuration changes in the traffic pattern,
- Fails to compensate for ballooning when deploying the flaps, resulting in an excess loss of airspeed and/or altitude gain,
- Fails to maintain coordinated flight throughout the traffic pattern,
- Has trouble visualizing and becoming oriented with runway configuration resulting in confusion and non-standard pattern entry,
- Exhibits poor airspeed control during downwind, base, and final,
- Fails to reduce power and pitch on the upwind or crosswind leg resulting in excessive airspeed and/or altitude above traffic pattern altitude.

## Stabilized Approach Definition

A stabilized approach is critical to a safe, successful landing. A stabilized approach is characterized by a constant angle and constant rate of descent approach profile ending near the touch-down point. Stabilized approach criteria apply to all approaches including practice power-off approaches.

### VFR Stabilized Approach Definition

All briefings and appropriate checklists should be completed by 500' AGL in visual conditions.

A VFR approach is considered stabilized when all of the following criteria are achieved by 500' AGL:

- Proper airspeed,
- Correct flight path,
- Correct aircraft configuration for phase of flight,
- Appropriate power setting for aircraft configuration,
- Normal angle and rate of descent,
- Only minor corrections are required to correct deviations.

A go-around must be executed if the above conditions are not met and the aircraft is not stabilized by 500' AGL.

### IFR Stabilized Approach Definition

All briefings and appropriate checklists should be completed prior to the IAF for instrument conditions.

An IFR approach is considered stabilized when all of the following criteria are met prior to the FAF, and continues to touch-down:

- Proper airspeed,
- Correct flight path,
- Correct aircraft configuration for phase of flight,
- Appropriate power setting for aircraft configuration,
- Normal angle and rate of descent,
- Only minor corrections with pitch and power are required to correct airspeed and glide path deviations,
- Normal bracketing (+/- 5°) is used to correct for lateral and vertical navigation deviations.

• Note •

Keep flaps at 50% for landing unless the runway is in sight and landing is assured before 500' AGL. Ensure sufficient runway length is available for a 50% flap landing.

A missed approach must be executed if the above conditions are not maintained during an instrument approach.

## Instrument Approach Procedures

The following Approach sections outline the operating procedures for executing precision and nonprecision approaches. The information describes the best way to configure the aircraft for given instrument procedures, complete checklist items, and configure avionics in Cirrus aircraft. The purpose of this section is to supplement the information in the POH and provide greater guidance on the completion of various instrument procedures in the aircraft. The techniques outlined in this section may not be inclusive of all variables encountered in the national airspace system. Pilots should follow these standard procedures when applicable and exercise good judgment for non-standard procedures. To reduce workload during the descent and instrument approach procedure follow these recommendations.

- Obtain destination weather information as soon as possible to determine active runways and applicable approaches,
- Set applicable COM and NAV frequencies prior to descent,
- Use the autopilot while briefing and preparing for the approach,
- Reduce unnecessary communications and distractions during the approach,
- Use the Descent and Before Landing flows outlined in this manual to complete checklist and avionics set up procedures. Always reference the checklist after the flow is complete,
- Brief the approach using the guidelines listed in this section.

### Approach Briefing

The purpose of an approach briefing is to prepare the pilot to execute an instrument approach procedure. Pilots should brief the instrument approach procedure when time and workload permits. Preferably, the approach should be briefed approximately 20 minutes prior to the IAF or start of vectors. The approach briefing should include the following items:

- Type of procedure and runway (e.g. ILS 35L),
- Transition to final (vectors or IAF),
- Applicable COM and NAV frequencies,
- Approach altitudes and DA or MDA,
- Airspeeds and configuration changes,
- MAP and missed approach procedure.



Sample Approach Briefing

This will be a \_\_\_\_\_ (ILS, GPS...) approach to RWY \_\_\_\_\_ via the \_\_\_\_\_ transition (VTF or IAF). The proper navigation source (GPS, VLOC) for the approach is selected and the proper course of \_\_\_\_\_ is set in the HSI. Applicable approach frequencies are tuned and identified. Final approach speed is \_\_\_\_\_ KIAS with approach flaps (50%) set prior to the FAF. Call out 1000 feet, 500 feet and 100 feet above minimums. The minimum altitude for the approach is \_\_\_\_\_ feet. The missed approach procedure is climb to \_\_\_\_\_ altitude and turn left/right to the \_\_\_\_\_ fix and hold.

## Precision Approach Procedure

The following section provides guidance for executing a precision approach using vectors to final or full procedure as the transition. The precision approach profile may be used for ILS, LPV, and LNAV/VNAV approaches, or any approach that has lateral and vertical course guidance.

### Avionics Configuration

#### Autopilot (If Desired)

| Approach Segment                     | Garmin GFC 700   |               | S-Tec 55X / 55SR |                       |
|--------------------------------------|------------------|---------------|------------------|-----------------------|
|                                      | Lateral Mode     | Vertical Mode | Lateral Mode     | Vertical Mode         |
| Vector to Final                      | HDG <sup>a</sup> | As Required   | HDG              | As Required           |
| Cleared to IAF                       | NAV (GPS)        | As Required   | NAV GPSS         | As Required           |
| Proc Turn Outbound / Course Reversal | NAV (GPS)        | As Required   | NAV GPSS         | As Required           |
| Inbound to FAF                       | APR (GPS/LOC)    | ALT           | NAV APR          | ALT                   |
| FAF Inbound                          | APR (GPS/LOC)    | GS or GP      | NAV APR          | GS or VS <sup>b</sup> |
| Missed Approach                      | GA <sup>c</sup>  | GA            | NA               | NA                    |

- a. Arm NAV when cleared to intercept final, arm APR when cleared for the approach.
- b. 55SR cannot track glideslope. Use VS mode and appropriate descent rate to track GS.
- c. Press the Go-around button at the decision altitude or missed approach point. Ensure the altitude bug is set to the assigned missed approach altitude.

#### FMS

- Load approach with assigned transition (VTF or IAF) and set the appropriate BARO minimums for the approach,
- Verify all Flight Plan waypoints are correct including course reversals,
- Activate the approach at the start of approach vectors or when cleared direct to the IAF,
- Verify all approach frequencies are tuned and identified,

- Verify the navigation mode switches from GPS to LOC on an ILS approach when inbound to FAF.

### MFD

- Reference charts for approach information and briefing,
- Reference the electronic checklist at the completion of the Descent and Before Landing flows.

### PFD

- Set the Altitude bug for the Missed Approach Altitude (DA with S-Tec AP) once established inbound to FAF,
- Sync the HDG bug for the wind correction heading once established inbound on the final approach course.

## **Completion Standards**

- Complies with all ATC clearances, instructions, and procedures in a timely manner,
- Establishes aircraft configuration and airspeed as recommended in this manual,
- Completes the Descent and Before Landing checklists prior to the FAF,
- Completes an approach briefing before becoming established on a published segment of the approach,
- Before the FAF, maintains altitude +/-100 feet, airspeed +/-10 KIAS, headings within +/-10 degrees, and accurately tracks radials, courses, and bearings,
- Completes all avionics related tasks correctly and at the proper time based upon ATC clearances,
- Maintains a stabilized final approach, from the FAF to DA allowing no more than three-quarter-scale deflection of either localizer or glideslope and maintains airspeed +/-10 KIAS,
- Promptly initiates a missed approach from the DH if required visual references for the runway are not unmistakably visible,
- Transitions to a normal landing considering all regulatory requirements to descend below a DA,
- Maintains localizer and glideslope deviations within three-quarter-scale deflections during visual descent until glide-slope signal must be abandoned to accomplish a normal landing.

## **Common Errors**

- Fails to slow the aircraft to provide adequate time for approach preparation,
- Fails to configure the aircraft as recommended in this section,
- Exhibits improper airspeed management during level-off or start of descents during the approach,
- Neglects to verify that the autopilot is active and armed modes,
- Fails to activate the approach in the flight plan at the proper time,
- Fails to brief missed approach procedures.

| Approximate Power Settings        | SR20         | SR22         | SR22TN       | SR22T          |
|-----------------------------------|--------------|--------------|--------------|----------------|
| Start of Vectors / Cleared to IAF | As required  | As required  | As required  | As required    |
| Final Intercept                   | As required  | As required  | As required  | As required    |
| 1/2 Scale Below Glideslope        | 50% / 22" MP | 30% / 15" MP | 50% / 15" MP | 40% / 15" MP   |
| FAF Inbound                       | 25% / 12" MP | 15% / 12" MP | 25% / 12" MP | 30% / 12.5" MP |
| Missed Approach                   | Full Power   | Full Power   | Full Power   | Full Power     |

Precision Approach Briefing Elements

- Type of procedure and runway (e.g. ILS 31),
  - Transition to final (VTF or IAF),
  - Applicable Nav and Com frequencies,
  - DA/MDA,
  - MAP and missed approach procedure.
- Note •
  - Set ALT bug to the Missed Approach altitude prior to the FAF,
  - Sync the HDG bug once established inbound, on the final approach course,
  - Execute a missed approach anytime the outlined stabilized approach criteria are not met.

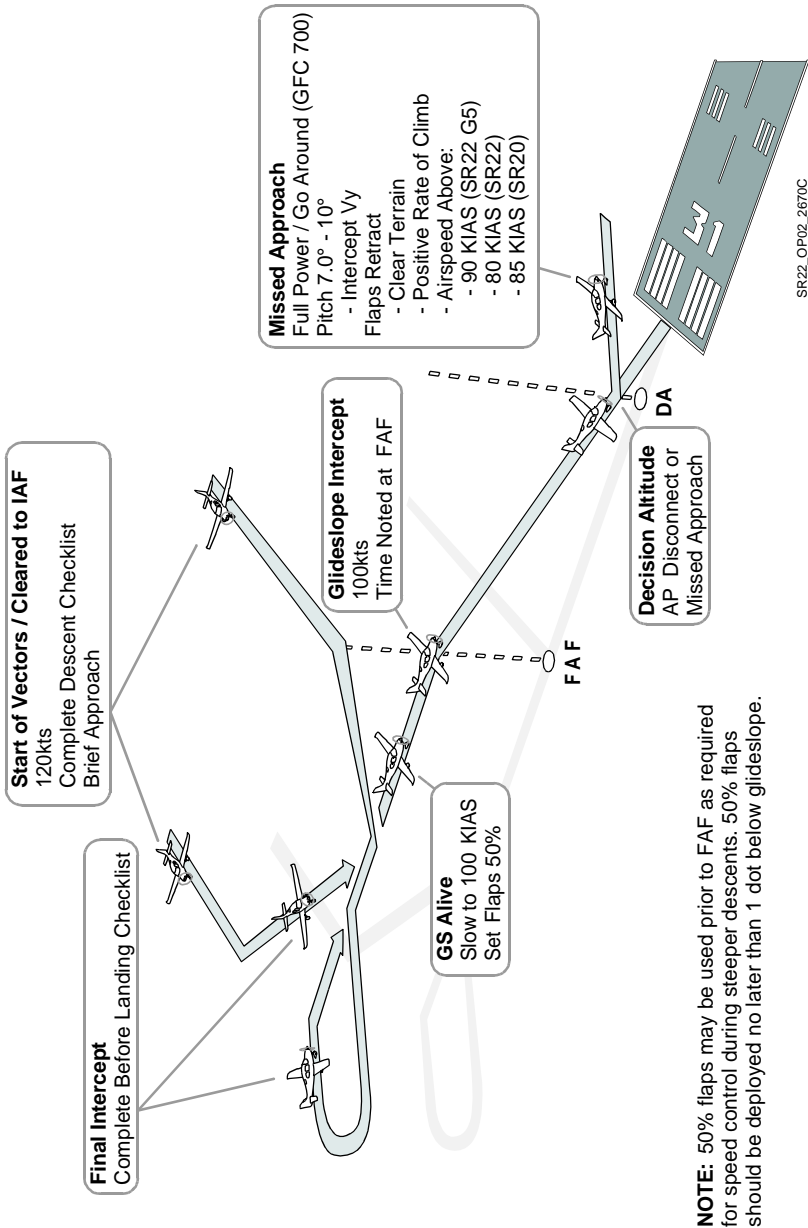

**Figure 3-3**  
**Precision Approach Profile**

## Nonprecision Approach Procedure

The following provides guidance for executing a nonprecision approach with no vertical guidance using vectors to final or full procedure as the transition. The nonprecision profile may be used for VOR, Localizer, Localizer Back Course, GPS, or any approach that only has lateral course guidance.

### Avionics Configuration

#### Autopilot (If Desired)

| Approach Segment                     | Garmin GFC 700          |               | S-Tec 55X / 55SR          |               |
|--------------------------------------|-------------------------|---------------|---------------------------|---------------|
|                                      | Lateral Mode            | Vertical Mode | Lateral Mode              | Vertical Mode |
| Vector to Final                      | HDG <sup>a</sup>        | As Required   | HDG                       | As Required   |
| Cleared to IAF                       | NAV (GPS)               | As Required   | NAV GPSS                  | As Required   |
| Proc Turn Outbound / Course Reversal | NAV (GPS)               | As Required   | NAV GPSS                  | As Required   |
| Inbound to FAF                       | NAV (GPS, VOR, LOC, BC) | ALT           | GPSS (GPS) APR (VOR/ LOC) | ALT           |
| FAF Inbound                          | APR (GPS, VOR, LOC, BC) | VS + ALTS     | GPSS (GPS) APR (VOR/ LOC) | VS +ALT       |
| Missed Approach                      | GA <sup>b</sup>         | GA            | NA                        | NA            |

a. Arm NAV when cleared to intercept final, arm APR when cleared for the approach.

b. Press the Go-around button at the decision altitude or missed approach point. Ensure the altitude bug is set to the assigned missed approach altitude.

#### FMS

- Load approach with assigned transition (VTF or IAF) and set appropriate BARO minimums for the approach,
- Verify all Flight Plan waypoints are correct including course reversals,
- Activate the approach at the start of approach vectors or when cleared direct to the IAF,
- Verify all approach frequencies are tuned and identified,

- Verify the navigation mode is set as required (GPS, VOR, LOC, or BC).

### MFD

- Reference charts for approach information and briefing,
- Reference the electronic checklist at the completion of the Descent and Before Landing flows.

### PFD

- Set Altitude bug for the Minimum Descent Altitude (MDA) once established inbound to FAF,
- Set the HDG bug for the wind correction heading once established inbound on the final approach course.

## **Completion Standards**

- Complies with all ATC clearances, instructions, and procedures,
- Establishes aircraft configuration and airspeed per recommendations described in this manual,
- Completes the Descent and Before Landing checklists prior to the FAF,
- Completes an approach briefing before being established on a published segment of the approach,
- Pre FAF, maintains altitude +/-100 feet, airspeed +/-10 KIAS, headings +/-10 degrees, and accurately tracks radials, courses, and bearings,
- Correctly completes all avionics related tasks at the proper time based upon ATC clearances,
- Ensures GPS RAIM is available and the CDI is in APR mode before commencing the approach past the FAF and determines the appropriate approach minimums,
- Maintains a stabilized final approach from the FAF to MAP allowing no more than three quarter scale CDI deflection, with airspeed +/-100 KIAS, and altitude within +100 / -0 feet from the MDA,
- Promptly initiates a missed approach from the MAP if required visual references for the runway are not unmistakably visible,
- Transitions to a normal landing, considering all regulatory requirements to descend below a MDA.



## Common Errors

- Fails to slow the aircraft to provide adequate time for approach preparation,
- Fails to verify CDI sensitivity and RAIM,
- Fails to configure the aircraft as recommended in this section,
- Exhibits improper airspeed management during level-off or start of descents during the approach,
- Fails to verify the autopilot's active and armed modes,
- Fails to activate the approach in the flight plan at the proper time,
- Fails to brief missed approach procedures.

| Approximate Power Settings        | SR20         | SR22         | SR22TN       | SR22T          |
|-----------------------------------|--------------|--------------|--------------|----------------|
| Start of Vectors / Cleared to IAF | As required  | As required  | As required  | As required    |
| Final Intercept                   | As required  | As required  | As required  | As required    |
| 2 NM to FAF                       | 50% / 22" MP | 30% / 15" MP | 50% / 15" MP | 40% / 15" MP   |
| FAF Inbound                       | 25% / 12" MP | 15% / 12" MP | 25% / 12" MP | 30% / 12.5" MP |
| Missed Approach                   | Full Power   | Full Power   | Full Power   | Full Power     |

Nonprecision Approach Briefing Elements

- Type of procedure and runway (e.g. LOC 31),
- Transition to final (VTF or IAF),
- Applicable Nav and Com frequencies,
- MDA,
- MAP and missed approach procedure.

• Note •

- Set ALT bug to the MDA prior to FAF,
- Sync the HDG bug once established inbound,
- Execute a missed approach anytime the outlined stabilized approach criteria are not met.

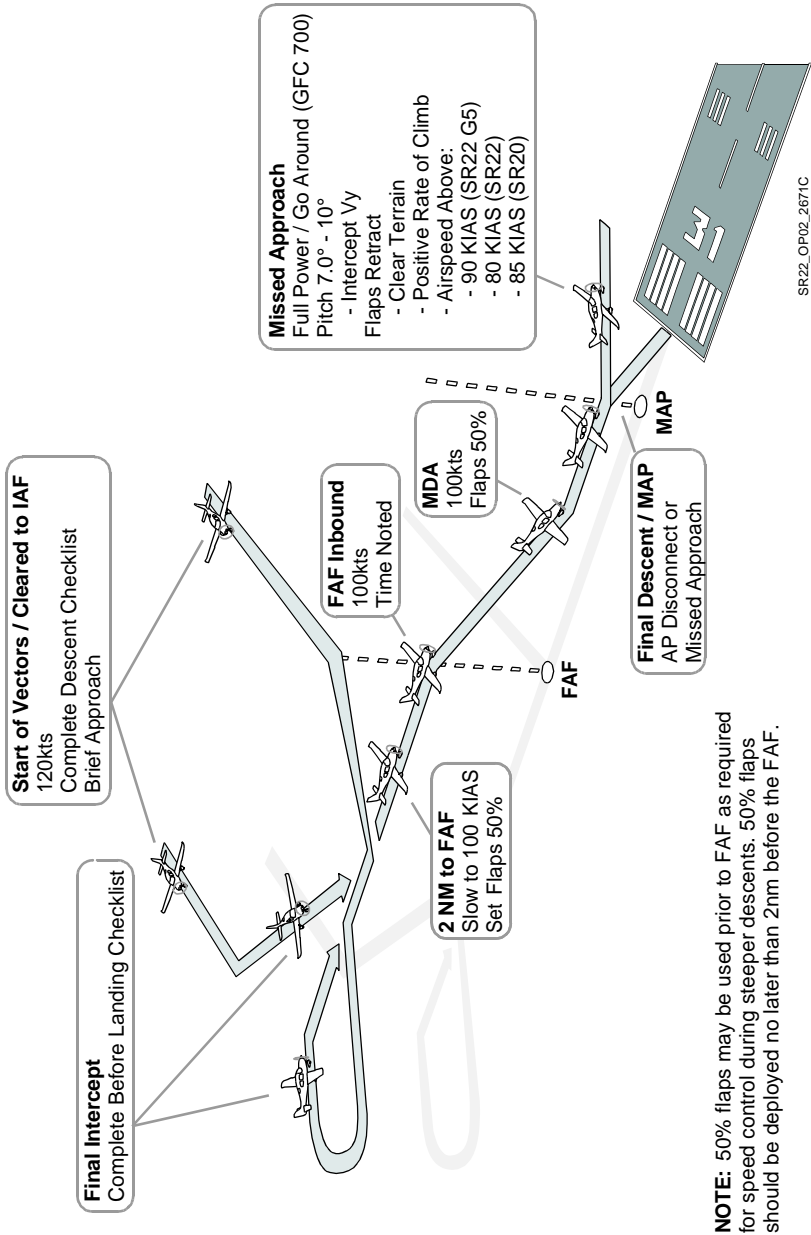

Figure 3-4  
Nonprecision Approach Profile

## Go-Around

A go-around should be executed anytime an approach does not meet the stabilized approach criteria outlined in this manual for instrument or visual conditions. A go-around should be completed from memory since it is a time critical maneuver.

In addition to the stabilized approach criteria, execute a go-around/missed approach for these conditions:

- Excessive ballooning during round-out or flare,
- Excessive bouncing or porpoising,
- Landing beyond the first third of the runway,
- Any condition when a safe landing is in question.

The first priority of executing a go-around is to stop the aircraft's descent. Smoothly and promptly apply full power while simultaneously leveling the wings and pitching the aircraft to stop the descent. Maintain coordination while adding power by applying rudder pressure. Retract the flaps to 50%. Do not fully retract the flaps at this point in the go-around because it may lead to excessive altitude loss.

Begin pitching for a climb attitude once the aircraft's descent rate has been stopped and the aircraft is accelerating. Pitch for  $V_X$  if obstacle clearance is an issue. Pitch for  $V_Y$  for all other situations. Retract flaps to 0% once the aircraft is climbing, clear of obstacles, and above 80 KIAS (SR22), 85 KIAS (SR20), or 90 KIAS (SR22 G5).

### Procedure (Memory)

1. Autopilot .....DISENGAGE

GFC 700 - Disengage the autopilot by pressing the go-around button located on the throttle. The yaw damper will remain engaged after pressing the go-around button.

- Note •

Press the go-around button on the throttle handle when executing a missed approach from an IAP for aircraft equipped with the GFC 700 autopilot.

S-Tec 55X/SR - Disengaged the Autopilot by pressing the AP DISC on the control yoke.

2. Power Lever .....FULL FORWARD

Increase power lever to the full forward position. Ensure full power is used and do not stop at any detents along power lever travel.

3. Flaps .....50%  
Select flaps to 50% to decrease drag and maintain maximum lift as a climb is initiated.
4. Airspeed..... SEE BELOW  
SR20 - 81 to 83 KIAS  
SR22 - 75 to 80 KIAS  
SR22 G5 - 80 to 85 KIAS
5. Flaps ..... UP  
Verify flaps have been retracted to 0%. If not, ensure the following criteria is met before retracting the flaps:
  - SR20 - 85 KIAS
  - SR22 - 80 KIAS
  - SR22 G5 - 90 KIAS
  - Positive rate of climb
  - Clear of terrain and obstacles
  - FIKI - Retract as soon as practical once conditions are met. Extending flaps in icing conditions can reduce the effectiveness of the elevator and horizontal stabilizer and could potentially lead to a tail stall.

## Completion Standards

- Makes a timely decision to discontinue the approach or landing considering approach stability, clearances, and runway obstructions,
- Applies full power immediately and transitions to a climb pitch attitude for  $V_y$  and maintains  $V_y +10/-5$  KIAS,
- Retracts flaps from 100% to 50% after full power is applied and pitch attitude is established,
- Retracts flaps when climbing, clear of obstacles and airspeed above 85 (SR 20), 80 KIAS (SR22/T), or 90 KIAS (SR22 G5) respectively,
- Assesses potential traffic conflicts and maneuvers as required to avoid traffic conflicts,

- Announces the go-around to the control tower or local traffic after the aircraft is climbing at the desired airspeed with configuration set and when workload permits.

## **Common Errors**

- Fails to recognize and initiate a go-around,
- Fails to apply full takeoff power,
- Fails to maintain coordination during a go-around,
- Neglects to disconnect the autopilot,
- Retracts flaps before adding power,
- Improper pitch control resulting in excessive loss of altitude, stall entry, or both,
- Announces go-around before regaining aircraft control,
- Fails to keep the aircraft aligned and over the runway throughout the go-around and initial climb.

## Approach and Landing Speeds

| Approach Speeds                      | SR20                       | SR22       | SR22 G5    |
|--------------------------------------|----------------------------|------------|------------|
| 100% Flaps                           | 78 KIAS                    | 80-85 KIAS | 80-85 KIAS |
| 50% Flaps                            | 83 KIAS                    | 85-90 KIAS | 85-90 KIAS |
| 0% Flaps                             | 88 KIAS                    | 90-95 KIAS | 90-95 KIAS |
| Short-field (100% Flaps)             | 78 KIAS                    | 77 KIAS    | 79 KIAS    |
| 50 ft Speed - $V_{REF}$ (100% Flaps) | 78 KIAS                    | 77 KIAS    | 79 KIAS    |
| Touch-down Speed                     | Slightly Above Stall Speed |            |            |
| Max Demonstrated Crosswind           | 20 KIAS                    |            | 21 KIAS    |

## Normal Landing

Normal landings should be made with 100% flaps. Final approach speeds should be adjusted to account for gusts exceeding 10 KTS by adding half of the gust factor. Reduce power smoothly and begin slowing from the final approach speed at a time that allows an easy transition from final descent to round-out and flare with minimum floating or ballooning. Touch-downs should be made on the main wheels first at speeds slightly above stall. Gently lower the nose wheel after the mains are on the ground.

### Completion Standards

- Considers the wind conditions, landing surface, obstructions, and selects a suitable touch-down point within the first 1/3 of the runway,
- Establishes the aircraft approach and landing configuration and airspeed as recommended, and adjusts pitch and power as required,
- Maintains a stabilized approach and recommended airspeed +/- 5 KIAS with wind gust factor applied,
- Manages airspeed and power to minimize floating during round-out,
- Touches down smoothly at approximate stalling speed,
- Touches down at or within 400 feet beyond a specified point, with no drift, and with the airplane's longitudinal axis aligned with and over the runway centerline,
- Maintains crosswind correction and directional control throughout the approach and landing sequence,
- Completes the Before Landing checklist,
- Uses brakes as required while maintaining directional control. Keeps the runway centerline between the main landing gear until reaching the desired turnoff point,

### Common Errors

- Flares too high creating a stall to hard landing situation,
- Touches down 5 to 10 KIAS above stall speed causing a flat landing attitude and possible pilot-induced oscillation,



- Fails to keep the aircraft on the centerline throughout the landing roll,
- Fails to initiate a go-around for unsafe landing situations,
- Fails to continuously add back pressure to slow the aircraft during round-out into the flare,
- Relaxes elevator back pressure during flare to quickly after touch-down.

## Short-Field Landing

Landings on short runways should be made with 100% flaps. Final approach speeds should be adjusted to account for wind gusts exceeding 10 KIAS by adding half the gust factor. Progressively reduce power after clearing all approach obstacles. Proper airspeed and power control should result in an approach with minimal floating in ground effect without excessive sink rates during the approach. Touch-down should be made on the main wheels first. Immediately after touch-down, ensure power is at idle, lower the nose wheel and apply brakes as required. To decrease stopping distances, consider retracting the flaps and holding the control yoke full aft. Emphasis should be placed on the accuracy of the touch-down to ensure enough runway remains after touch-down to stop the aircraft.

### Completion Standards

- Adheres to applicable completion standards for normal landings,
- Touches down at or within 200 feet beyond a specified point, with no side drift, minimum float and with the airplane's longitudinal axis aligned with and over the runway center,
- Applies brakes and elevator control as necessary to stop in the shortest distance consistent with safety,
- Executes a go-around if sufficient runway for braking is not available.

### Common Errors

- Selects and tracks to an aiming point that results in a touch-down beyond the desired landing point,
- Touches down before the specified touch-down point,
- Touches down 200 feet beyond the specified touch-down point,
- Fails to adjust approach angle to compensate for obstacles if applicable,
- Fails to recognize the need for a slip to landing for obstacle clearance purposes,
- Fails to adjust airspeed to the recommended short-field approach speed,
- Applies excessive braking causing undue brake wear or loss of directional control.

## Soft-Field Landing

Cirrus aircraft are approved for landings on soft field and turf runways. Add 20% to the landing ground-roll distance when landing on a dry grass runway and 60% when landing on a wet grass runway. Always ensure that the quality and condition of the runway surface is adequate to support the aircraft. Avoid turf runways with long grass, wet or soggy soil, large ruts or holes. A soft field approach is quite similar to a normal landing approach. Touch-downs should be made on the main wheels first. A soft touch-down will reduce the stress on the landing gear and make it easier to keep the nose wheel from digging into the turf preventing a loss of directional control. Keep the nose wheel off the ground as long as possible by applying sufficient back pressure to the control yoke. A little power can be added immediately after touch-down to aid in keeping the nose wheel off the ground. Braking should be minimized. Excessive braking could lead to a loss of directional control on the runway. Higher power settings will be required to taxi on a soft field.

### Completion Standards

- Adheres to applicable completion standards for normal and short-field landings,
- Touches down smoothly on the main landing gear and holds full elevator aft controls throughout the landing roll and taxi,
- Applies brakes only as required and maintains directional control without locking the brakes during the landing roll.

### Common Errors

- Fails to accurately assess height above touch-down resulting in a flat, hard, or unsafe touch-down,
- Fails to touch-down accurately resulting in a runway over run situation,
- Fails to hold full elevator back pressure to reduce nose wheel pressure/fatigue,
- Fails to assess runway condition before attempting takeoff or landing,
- Fails to account for sunrise or sunset times when planning a flight out of, or into an unlit soft field runway.

## Crosswind Landing

Crosswind landings should be made with 100% flaps. It is recommended to crab the aircraft into the wind sufficiently enough to track the aircraft along the extended centerline of the runway. Hold the crab until the beginning of the round-out. At the start of the round-out, enter a slip by applying rudder pressure to align the longitudinal axis of the aircraft with the runway and simultaneously apply aileron to keep the aircraft tracking the runway centerline. Touch-downs should be made on the upwind main landing gear first, followed by the downwind main landing gear, and nose gear. Hold aileron correction into the wind during the rollout and apply rudder as necessary to maintain directional control.

### Completion Standards

- Adheres to applicable completion standards for normal, short-field, and soft field landings,
- Identifies need for crosswind technique,
- Smoothly applies rudder and aileron inputs to align the longitudinal axis of the aircraft with the runway over the runway centerline with no drift as the aircraft enters the round-out phase of landing,
- Holds aileron crosswind control inputs after touch-down and through the landing roll,
- Identifies crosswind conditions that exceed the pilot's capabilities and develops alternative plans for safe landing,
- Selects 100% flaps.

### Common Errors

- Applying excessive control inputs resulting in uncoordinated flight,
- Fails to hold ailerons into the wind after touch-down with no drift,
- Touches down with drift,
- Fails to recognize an unsafe crosswind situation and fails to select a more suitable landing runway,
- Develops marginal crosswind proficiency on a long and wide runway. Pilot then assumes he or she will be proficient on shorter and narrower runways.

## Reduced Flap Landings (0% and 50%)

While most landings in Cirrus aircraft are performed with 100% flaps, it is important for pilots to develop proficiency landing with 50% or 0% flaps. Landing with less than 100% flaps should be considered a non-typical situation requiring a heightened sense of awareness and caution. Final approach speeds are increased by 5 KIAS for 50% flap and 10 KIAS for 0% flap landings due to the increased stall speed with reduced flap deflection. A slightly larger traffic pattern will be required to descend the aircraft on an approximately 3 degree glidepath to the runway without excessively high descent rates.

Pilots must also be aware that the aircraft will be at a higher angle of attack as compared to a landing with full flaps on final approach and during touch-down. Pilots are cautioned to not exceed 10 degrees of nose high pitch during the round-out and flare to prevent a tail strike. Landing distances with reduced flaps will be greater due to increased final approach and touch-down speeds.

Pilots landing from an instrument approach procedure may elect to land with approach flaps (50%) if changing flap configuration on short final will create an unstabilized approach. Increase final approach speed and ensure adequate runway remains for safe stopping.

### Completion Standards

- Adheres to applicable completion standards for normal, short-field, and/or crosswind landings,
- Selects a runway with adequate distance,
- Adjusts final approach speed as required,
- Adjusts traffic pattern as necessary for a stabilized approach,
- Does not flare the aircraft excessively during round-out and flare.

### Common Errors

- Fails to select a runway with adequate distance,
- Overshoots desired touch-down point excessively,
- Over rotates the aircraft during round-out or flare,
- Fails to adjust traffic pattern for reduced flap landing,
- Elects to land with 50% flaps in crosswind conditions when normal procedure calls for 100%.

## Icing Landing Procedure

1. ICE PROTECT System Switch..... On

It is important to ensure the switch has been set to the intended position. This is especially true for night operations.

2. ICE PROTECT Mode Switch..... HIGH / As Required

HIGH should be selected initially. If ice accumulation rate is low, select NORM. If ice does not shed, select MAX and perform the Anti-ice System Failure checklist.

3. WIND SHLD Push-Button ..... Press As Required

Use the windshield ice protection when residual fluid that is slung from the propeller will not keep the windshield free of ice.

• Caution •

To prevent an obstructed view due to residual anti-ice fluid on windshield, do not operate windshield ice system within 30 seconds of landing.

4. Ice Inspection Lights ..... As Required

Ice inspection lights will illuminate the leading edges of the wings and horizontal stabilizer in order to monitor ice accumulation and confirm fluid flow at night.

5. Flaps .....50%

Approaches and landings in icing conditions or with ice adhering to the aircraft should be made with 50% flaps. Extending flaps to 100% in icing conditions can reduce the effectiveness of the elevator and horizontal stabilizer and could potentially lead to a tail stall.

6. Airspeed..... Minimum of 95 KIAS

Residual ice on the protected areas and ice accumulation on the unprotected areas of the airplane can cause an increase in stall speed even with the anti-ice system operating. Refer to the Stall Speeds with 45 Minute Ice Accumulation chart in the TKS Anti-ice System supplement.

7. Airspeed on Short Final .....88 KIAS

Airspeed should be no less than 88 KIAS if icing conditions exist or with ice adhering to the airframe due to the possibility of an increased stall speed.

## Completion Standards

- Adheres to applicable completion standards for normal and short-field landings,
- Identifies the need, actual or simulated by the instructor, to perform the icing landing procedure,
- Selects a runway with adequate landing distance to perform the icing landing procedure considering landing distances and ground roll published in the TKS Anti-Ice Supplement.

## Common Errors

- Fails to identify the need for the icing landing procedure,
- Neglects to assess the landing distance performance implications of the icing landing procedure,
- Lands with over-rotation causing a tail strike.

## After Landing

Complete the After Landing checklist as a flow after clearing the active runway. Ensure the pitot heat is turned off. The mixture can be leaned if desired. Set the mixture by leaning for max RPM rise.

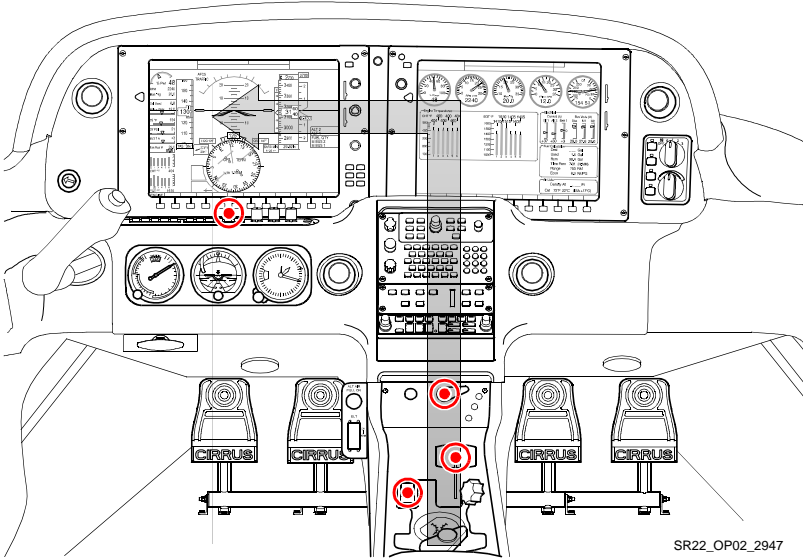

### After Landing Flow

#### Procedure (Flow Pattern)

1. Power Lever ..... 1000 RPM  
Reduce power to 1000 RPM during taxi. Changes in engine speed should be used to accelerate or decelerate the aircraft along with minimal braking as necessary.
2. Fuel Pump ..... OFF  
Select Fuel Pump OFF after clearing runway.
3. Mixture (SR22TN/SR22T) ..... LEAN  
Lean the mixture for maximum RPM rise.

It is acceptable to lean the SR20 and SR22 using the same procedure described above for high altitude operations or if spark plug fouling is suspected.



4. Flaps ..... UP  
Select flaps to 0% (UP) after clearing runway.
5. Transponder .....STBY  
Ensure transponder has automatically cycled to STBY. If not, select STBY manually unless directed by ATC.
6. Lights ..... AS REQUIRED  
Reduce external lighting once clearing the runway to the minimum required for safe/legal operation so as to avoid creating a hazard to others.
7. Pitot Heat ..... OFF  
Select Pitot Heat OFF.
8. Ice Protection System ..... OFF  
Select Ice Protection System OFF if used for landing.

### Completion Standards

- Completes the after landing checklist procedure after clearing the active runway,
- (FIKI) Turns pitot heat off within 45 seconds after landing.

### Common Errors

- Completes checklist items during landing ground roll, before clearing the active runway, or during taxi,
- Neglects to complete checklist items and/or reference the checklist after landing.



as being HOT, and contact maintenance personnel immediately.

4. Mixture .....CUTOFF  
Reduce mixture control to the full CUTOFF position and ensure engine stops running. If the engine continues to run with the mixture at idle, ensure the boost pump is in the OFF position.
5. All Switches .....OFF  
Turn off all remaining switches including the air conditioning and fan if equipped.
6. Magnetos .....OFF  
Turn off magnetos and remove key.
7. ELT ..... TRANSMIT LIGHT OUT  
After a hard landing, the ELT may be activated. If this is suspected, press the RESET button located below the circuit breaker panel near the floor by the pilot's right ankle.
8. Chocks, Tie-downs, Pitot Cover ..... AS REQUIRED  
Set parking brake if required, chock both main wheels, use tie downs under wings and tail if necessary. Place pitot cover and static covers if needed.

### Completion Standards

- Completes shutdown checklist as described.

### Common Errors

- Fails to reference and follow the shutdown checklist procedure,
- Fails to turn the A/C or fan to the off position,
- Fails to turn the magnetos off,
- Fails to replace the CAPS pin during post flight.

Intentionally Left Blank

# Section 4

## Emergency & Abnormal Procedures

### General

Sections 3 and 3A of the Pilot's Operating Handbook provide the procedures for handling emergency and abnormal system and/or flight conditions which, if followed, will maintain an acceptable level of airworthiness and reduce operational risk. The guidelines described in these sections are to be used when an emergency or abnormal condition exists and should be considered and applied as necessary.

This section does not reference all emergency and abnormal procedures that are described in the Pilot's Operating Handbook. Reference this section for expanded guidelines on the selected procedures and cockpit flow diagrams for emergency procedure memory items.

The procedures described in this section are commonly practiced during flight training as a means to develop and assess a pilot's system and procedural knowledge and his or her ability to make correct decisions regarding the failure or emergency situation. Completion standards are provided for pilots and instructors when assessing performance. Reference the Common Errors sections to anticipate typical errors made by pilots when practicing these procedures.

### Checklist Usage for Abnormal Procedures

Completion of abnormal procedures should be done using the do-list method. The appropriate checklist should be directly referred to and each item should be completed in the order prescribed.

### Checklist Usage for Emergency Procedures

Emergency checklists should be completed from memory. The Emergency Procedures section of the POH identifies checklist items for emergency procedures that must be memorized. Execution of these procedures is considered time critical and is done without reference to a checklist. The checklist should only be referenced during an emergency if workload permits. Reference the emergency procedure flow patterns when practicing the completion of memory items.

## CAPS Deployment

The Cirrus Airframe Parachute System (CAPS) is a unique safety feature installed in all Cirrus aircraft. CAPS provides a level of protection to the pilot and passengers that is not common to most general aviation aircraft today. However, for CAPS to work, it must be manually activated by the pilot or a passenger at a safe altitude.

No minimum altitude for deployment has been set. This is because the actual altitude loss during a particular deployment depends upon the airplane's airspeed, altitude, and attitude at deployment as well as other environmental factors. In most cases, however, the chances of a successful deployment increases with altitude. As a data point, altitude loss from level flight deployments has been demonstrated at less than 400 feet, (561 feet G5), and altitude loss from spin deployments has been demonstrated at less than 920 feet, (1081 feet G5). If circumstances permit, it is advisable to activate the CAPS at or above 2,000 feet AGL.

The circumstances and decisions to use CAPS may or may not be readily apparent. The situations when CAPS should be considered will always be an emergency or pending emergency. The pilot must assess the risk of continued flight considering all known factors and determine the likelihood of a safe outcome. Whenever the safe outcome of a flight is in question and there is high risk of severe injury or death, CAPS should be used.

Pilots may encounter situations that require an immediate activation of CAPS such as: an engine failure after takeoff, mid-air collision, spin, or a loss of control in flight. CAPS must be activated quickly under these circumstances to preserve altitude and control airspeed within acceptable deployment parameters. Pre-briefing these circumstances often will help the pilot to react quickly and activate CAPS in a timely manner, increasing the probability of CAPS working properly. It is also important to note that CAPS has been activated by pilots at speeds in excess of 180 knots on multiple occasions with successful outcomes. Always keep in mind the best speed to activate CAPS is below  $V_{pd}$  if able.

Emergency situations in an aircraft are always stressful and pilots may overlook all available options for surviving the emergency. Pilots who regularly conduct CAPS training and think about using CAPS will often have a higher probability of deploying CAPS when necessary.

Performing CAPS training in a Cirrus flight training device or simulator is highly recommended. Visit [www.cirrusaircraft.com](http://www.cirrusaircraft.com) to find an interactive map displaying Cirrus Simulator Centers. It is also recommended that frequent flying passengers complete CAPS training in a Cirrus simulator to develop the ability to properly activate CAPS.





*After Deployment:*

3. Mixture ..... CUTOFF
4. Fuel Selector..... OFF
5. Bat-Alt Master Switches..... OFF  
If time permits, declare the emergency and announce CAPS activation prior to turning off the Bat and Alt switches.
6. Ignition Switch..... OFF
7. Fuel Pump ..... OFF
8. ELT ..... ON
9. Seat Belts and Harnesses ..... TIGHTEN
10. Loose Items ..... SECURE

11. Assume emergency landing body position.

Reference the passenger briefing card for the correct emergency landing body position. Be mindful of airbag seat belts if installed.

12. After the airplane comes to a complete stop, evacuate quickly and move upwind.

In high winds the parachute may inflate and drag the aircraft after touchdown. Remain upwind of the aircraft.

## Completion Standards

- Maintains situational awareness during the scenario and makes appropriate decisions,
- Recognizes the need to use CAPS by an appropriate altitude,
- If not in a loss of control situation, and if time and altitude permits, slows the airplane below V<sub>pd</sub>
- If in a loss of control situation immediately uses CAPS,
- Simulates the recommended procedure for pulling CAPS,
- Simulates the post deployment procedures time permitting and secures the cabin,
- Identified the correct emergency landing body position,
- Recognized the most appropriate door position during touchdown considering outside factors.

## Common Errors

- Fails to maintain situational awareness during the scenario,

- Descends below an appropriate altitude to deploy CAPS,
- Failure to slow below  $V_{pd}$ , when time and altitude permits,
- Failure to complete the post deployment CAPS procedures to secure the cabin,
- Failure to assume the emergency landing body position before ground impact.

## Emergency Descent

There are multiple situations that require the use of an emergency descent. For example, fire, medical emergency, or an O<sub>2</sub> malfunction are just a few. Whatever the reason, the main purpose of performing an emergency descent is to lose altitude as quickly as possible to avoid life-threatening hazards. For some scenarios, landing the aircraft at an airport or suitable off-airport landing site or deploying CAPS may be an additional objective.

To enter an emergency descent, reduce the power to idle and lower the nose approximately 10 - 15 degrees to intercept V<sub>NE</sub>. Pitch the aircraft to V<sub>NO</sub> if significant turbulence is expected during the descent.

Banking the aircraft to 45 degrees will help the aircraft accelerate more quickly as well as keep loading positive during the maneuver. It is recommended to bank the aircraft to 45 degrees until heading 90 degrees from the previous heading. From there, adjust heading as necessary for terrain, traffic, and/or a diversion airport.

Set the mixture control as recommended below and turn the boost pump on. Clear the engine every 1000 feet by increasing MP to 15 inches, then reducing back to idle. The combination of high airspeed and low power will cause CHTs to cool. It is good practice to allow the engine to warm before applying high power settings. When possible restore power to minimum necessary for level flight until CHTs return to green.

Inform ATC of the emergency and intended actions and request any assistance if necessary when workload permits.

### Procedure

1. Power Lever ..... IDLE

2. Mixture ..... AS REQUIRED.

- SR20 - full rich,
- SR22 - top of green fuel flow arc,
- SR22TN - full rich,
- SR22T - full rich.

3. Airspeed ..... V<sub>NE</sub>

Decrease pitch to 10 - 15 degrees to intercept V<sub>NE</sub>. Maintain V<sub>NO</sub> if turbulence is expected.

## Completion Standards

- Promptly recognizes the need for an emergency descent and enters the maneuver,
- Banks aircraft to 45 degrees during the start of the maneuver to load the aircraft and increase descent rate,
- Maintains airspeed  $\pm 0/-5$  KIAS of target airspeed for maneuver,
- Determines the best course of action considering the nature of the emergency.

## Common Errors

- Fails to reduce pitch sufficiently to accelerate to the desired airspeed,
- Overspeeds the aircraft beyond  $V_{NE}$ ,
- Fails to manage airspeed and altitude properly to execute a stabilized approach to landing,
- Fails to consider deploying CAPS at an appropriate altitude.

## Engine Malfunctions Overview

Proper pre-flight inspections, operating as per AFM recommendations, and routine maintenance all reduce the likelihood of an in-flight engine malfunction. Although engine malfunctions are a rare occurrence, pilots must be capable of properly identifying and troubleshooting while maintaining aircraft control.

Pilots are encouraged to actively scan engine instrumentation during flight to preemptively fend off or identify up and coming failures. Pay close attention to oil pressure and CHT status and trends.

Most engine malfunctions should be treated as emergencies. Pilots should be familiar with emergency procedure memory items and be capable of completing memory items in a timely fashion. Practice completing emergency procedure memory items during recurrent training and while sitting stationary in the aircraft.

### Training Limitations

- Simulated engine failures on takeoff and power-off return to airport during departure / climb maneuvers are not permitted,
- Simulated engine failures are not permitted in actual IMC or when VMC cannot be maintained,
- Ensure the aircraft is in a position to make an airport landing or landing at a suitable off-airport site when conducting these maneuvers in case a real emergency is encountered during the simulated emergency practice.

## Engine Failure In Flight

Fuel starvation is a major cause of engine failures in-flight. Neglecting to switch fuel tanks or attempting flight beyond fuel reserves are major contributing factors. Pilots are encouraged to program a scheduled message as a reminder to check the fuel balance every 30 minutes. Proper pre-flight planning and ensuring sufficient fuel reserves considering current or changing weather conditions for every flight is critical.

If time and workload permit, complete the Engine Air-start checklist in attempt to regain engine power. Proceed to the Emergency Landing Without Engine Power checklist if the engine fails to restart.

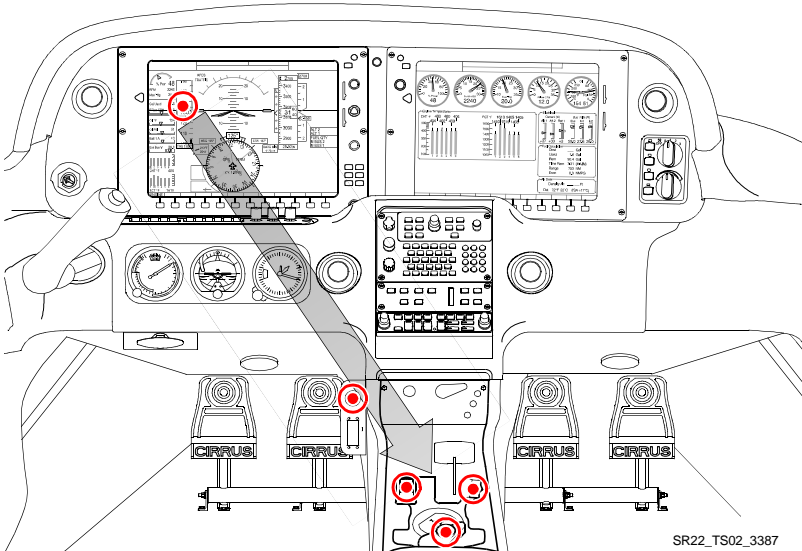

### Engine Failure In Flight

#### Procedure (SR20, SR22)

1. Best Glide Speed ..... ESTABLISHED  
Pitch to maintain altitude until the airspeed reaches best glide speed, then pitch down to maintain best glide speed.
2. Mixture ..... AS REQUIRED

Lean or enrichen the mixture in effort to supply the engine with a combustible fuel-air ratio. Use a smooth but prompt sweeping motion to re-initiate combustion.

3. Fuel Selector..... SWITCH TANKS

The engine should start shortly after switching fuel tanks if the cause of the engine failure was due to fuel starvation. Be mindful of maximum fuel imbalances and fuel reserves required to complete the flight.

4. Fuel Pump ..... BOOST

Turning the boost pump on will help suppress vapors that may be in the fuel lines and/or increase fuel pressure to the injectors. The engine will not run on the electric boost pump alone.

5. Alternate Induction Air .....ON

Press the center button on the alternate static source when pulling the alternate induction air control knob.

6. Ignition Switch.....CHECK, BOTH

Switch between the left and right magnetos. Leave the ignition on the magneto that causes the engine to fire for the remainder of the flight.

7. If engine does not start, proceed to CAPS Deployment or Forced Landing Checklist, as required.

## Procedure (SR22T and TN)

1. Best Glide Speed .....ESTABLISH  
Pitch to maintain altitude until the airspeed reaches best glide speed, then pitch down to maintain best glide speed.
2. Fuel Selector ..... SWITCH TANKS  
The engine should start shortly after switching fuel tanks if the cause of the engine failure was due to fuel starvation.
3. Ignition Switch ..... CHECK, BOTH  
Switch between the left and right magnetos. Leave the ignition on the magneto that causes the engine to fire for the remainder of the flight.
4. Fuel Pump ..... BOOST  
Turning the boost pump on will help suppress vapors that may be in the fuel lines and/or increase fuel pressure to the injectors. The engine will not run solely on the electric boost pump if the mechanical pump fails. High boost may be required above FL180 for vapor suppression.
5. Power Lever ..... 1/2 OPEN  
Set the power lever to half open before adjusting the mixture control. If the engine fires, make future power changes cautiously. Return the throttle to a running position if the engine fails during future throttle movements.
6. Mixture ..... IDLE CUTOFF, then slowly advance until engine starts
7. Perform Caps Deployment or Emergency Landing Without Engine Power checklist, as required.  
If engine Starts:
8. CHTs and Oil Temperature ... VERIFY within GREEN range, warm engine at partial power if required

## Completion Standards

- Maintains aircraft control with airspeed +/-10 KIAS of  $V_G$ ,
- Quickly steers the aircraft to suitable landing or CAPS deployment area,
- Positions the aircraft to a point where a stabilized approach to landing can be made,



- When workload permits, troubleshoots engine failure as described in the AFM,
- Secures engine if engine restart is not possible before landing,
- Simulates an emergency radio call and requests ATC assistance as necessary,
- Simulates a CAPS deployment at an appropriate altitude and airspeed, if necessary.

## Common Errors

- Loses excessive altitude by not pitching to  $V_G$  soon after the engine failure,
- Fails to troubleshoot failed engine as described in the AFM,
- Does not quickly determine, and steer the aircraft towards a suitable landing or CAPS deployment area and/or decide to deploy CAPS, if warranted, with adequate altitude,
- Overshoots or undershoots intended touchdown point,
- Fails to manage glide angle with flaps and/or side slip as necessary,
- Fails to simulate declaring an emergency and getting priority handling and assistance from ATC,
- Fails to consider surface winds when selecting landing direction.

## Emergency Landing Without Engine Power

The purposes of completing the Emergency Landing Without Engine Power checklist items are to secure the engine in an effort to reduce fire potential after touchdown and to alert ATC of the emergency situation through communication, transponder code, and ELT.

Turn the aircraft and glide towards an airport if available. Otherwise, glide the aircraft to the best location for CAPS deployment considering water, terrain, population density, etc. The flight path indicator on Perspective can be a useful tool to determine if the aircraft is capable of gliding to the intended airport. Monitor the flight path indicator when the aircraft is established and stabilized at best glide speed. If the flight path indicator points beyond the airport depicted on synthetic vision, a glide to the airport may be likely. Consider possible wind changes and the amount of maneuvering required to line up for a runway as the aircraft descends through altitude.

When reaching 2000 feet AGL, the pilot must make the decision whether to continue a gliding approach to landing or to activate CAPS. In many cases, CAPS will be the best option for survival, but it must be activated in time with sufficient altitude remaining. Do not continue an attempted landing unless landing is assured.

Maintain best glide speed with flaps at 0% until landing is assured. Use flaps to increase the descent angle when landing is assured. Eventually, flaps should be placed to 100% for touch-down. All power-off landings should be made with 100% flaps to reduce touchdown speed and potential impact forces.

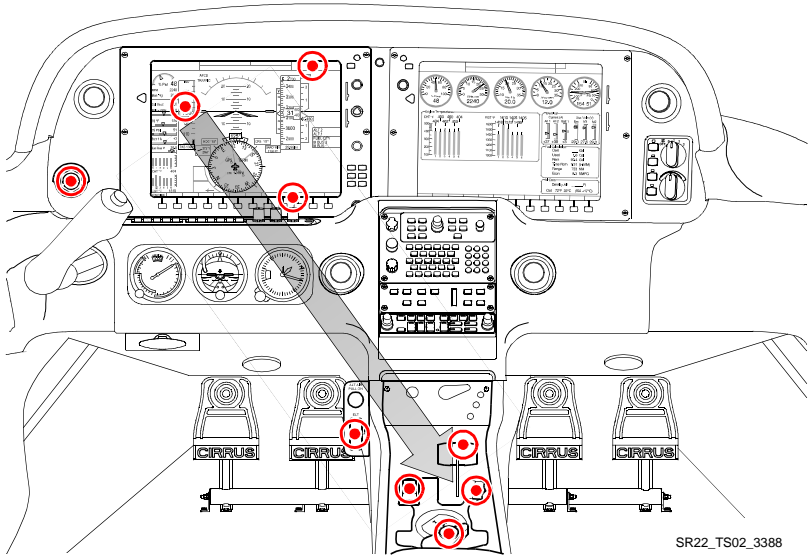

SR22\_TS02\_3388

### Emergency Landing Without Engine Power

#### Procedure

1. Best Glide Speed ..... ESTABLISH  
Pitch trim should be set approximately full aft for best glide airspeed. Pilots may consider using the IAS mode of the autopilot set to best glide to help with workload during the descent.
2. Radio ..... Transmit (121.5 MHz) MAYDAY giving location and intentions  
Use the current frequency to transmit the mayday call if currently in communication with ATC. Otherwise, transmit on 121.5.
3. Transponder ..... SQUAWK 7700
4. If off airport, ELT ..... ACTIVATE
5. Power Lever ..... IDLE
6. Mixture ..... CUTOFF
7. Fuel Selector ..... OFF
8. Ignition Switch ..... OFF
9. Fuel Pump ..... OFF
10. Flaps (when landing is assured) ..... 100%

- 11. Master Switches..... OFF
- 12. Seat Belt(s) ..... SECURED

### Completion Standards

- Completes the Emergency Landing Without Engine Power checklist when workload permits,
- Makes a good decision whether to continue to a landing or to activate CAPS,
- Maintains best glide speed +/-10KTS.

### Common Errors

- Fails to activate CAPS at a sufficient altitude,
- Hesitates to determine, and steer the aircraft towards, an airport within glide range,
- Descends at an airspeed much higher than best glide, reducing glide range,
- Fails to set 100% flaps for landing or extends flaps prematurely.

## Unexplained Loss of Manifold Pressure

If SR22T or SR22TN aircraft experience an unexpected loss of normal manifold pressure, the engine will typically revert to operation similar to a normally aspirated aircraft at approximately the same altitude. However, continued flight should only be conducted to the nearest suitable landing place in order to investigate the cause of the unexpected loss of normal manifold pressure.

The four most probable causes are:

1. A leak or rupture at an induction system coupling or a loose or failed induction coupling hose clamp.
  - a. This condition does not usually present a significant hazard, other than power loss equivalent to a normally-aspirated engine.
  - b. While this condition is the most probable, the following three conditions may present an immediate hazard to continued safe flight. Because it is difficult for the pilot to distinguish between a simple induction system leak and any of the more hazardous causes, all unexpected losses of manifold pressure should be assumed hazardous.
2. A significant leak in the exhaust system.
  - a. An exhaust leak may present a possible fire hazard. Reducing power and adjusting the mixture as described reduces the possibility of an engine compartment fire.
3. A loss of oil pressure to the wastegate actuator due to a general loss of engine oil pressure.
  - a. Potentially caused by a failed oil line, oil line fitting, or oil pump
  - b. Failure to maintain normal full manifold pressure at altitude may be an early indication of an oil leak and impending loss of oil pressure.
  - c. Monitor for reduction in oil pressure; if observed continue to diversion airfield, but prepare for forced landing.
4. A failure of an internal component in the turbocharger.
  - a. If the pilot experiences a sudden loss of manifold pressure and later observes declining oil pressure, it may be due to a failure of an internal turbocharger component. If there is a loss of oil pressure due to a failure of the turbocharger, engine oil may be vented through the tail pipe overboard.

- b. Monitor for reduction in oil pressure; if observed continue to diversion airfield, but prepare for forced landing.

## Training Limitations

- Limit failure to VMC,
- Maintain at least 15" of manifold pressure above FL180.

## Procedure

1. Power ..... ADJUST to minimum required for sustained flight
2. Mixture ..... ADJUST for EGTs between 1300 to 1400 degrees F  
The mixture will need to be enriched as the aircraft descends through altitude to maintain a combustible fuel-air ratio.
3. Descend to MINIMUM SAFE ALTITUDE from which a landing may be safely accomplished.  
Descent at best glide speed to extend glide range if necessary.
4. Divert to nearest suitable airfield.  
Consider CAPS if a landing at a suitable airfield is not available.
5. Radio.....Advise ATC landing is urgent or Transmit (121.5 MHz) MAYDAY giving location and intentions when workload permits.
6. Oil Pressure ..... MONITOR  
A loss of engine oil pressure may cause the loss of manifold pressure. Plan for a forced landing or CAPS activation if oil pressure is steadily decreasing or low.
7. Land as soon as possible.  
Continuously monitor for signs of fire. Shut the engine OFF immediately at the first indications of a fire and initiate an emergency descent to a landing or CAPS activation.

## Completion Standards

- Recognizes the failure and promptly completes the emergency checklist items,
- Selects a suitable diversion airport and completes necessary arrival tasks,
- Maintains aircraft control, using available power to minimize descent rate,

- Monitors engine indications and describes possible indications of turbo or wastegate failures,
- Continuously monitors for signs of fire.

### **Common Errors**

- Fails to describe the potential causes of the failure,
- Does not treat the failure as a potential emergency,
- Fails to land at the nearest suitable airport,
- Fails to maintain aircraft control due to the increased workload.

## Engine Roughness or Partial Power Loss

If a partial engine failure permits level flight, land at a suitable airfield as soon as conditions permit. If conditions do not permit safe level flight, use partial power as necessary to set up a forced landing pattern over a suitable landing field. Always be prepared for a complete engine failure and consider CAPS deployment if a suitable landing site is not available. Refer to the AFM Section 10, Safety Information, for CAPS deployment scenarios and landing considerations.

### Procedure

1. Air Conditioner (if installed) ..... OFF
2. Fuel Pump ..... BOOST  
Selecting BOOST on may clear the problem if vapor in the injection lines is the problem or if the engine-driven fuel pump has partially failed. The electric fuel pump will not provide sufficient fuel pressure to supply the engine if the engine-driven fuel pump completely fails.
3. Fuel Selector ..... SWITCH TANKS  
Selecting the opposite fuel tank may resolve the problem if fuel starvation or contamination in one tank was the problem.
4. Mixture ..... CHECK appropriate for flight conditions
5. Power Lever ..... SWEEP  
Sweep the Power Lever through range as required to obtain smooth operation and required power.
6. Alternate Induction Air (SR20 or SR22) ..... ON  
A gradual loss of manifold pressure and eventual engine roughness may result from the formation of intake ice. Opening the alternate engine air will provide air for engine operation if the normal source is blocked or the air filter is iced over.
7. Ignition Switch ..... BOTH, L, then R  
Cycling the ignition switch momentarily from BOTH to L and then to R may help identify the problem. An obvious power loss in single ignition operation indicates magneto or spark plug trouble. Lean the mixture to the recommended cruise setting. If engine does not smooth out in several minutes, try a richer mixture



setting. Return ignition switch to the BOTH position unless extreme roughness dictates the use of a single magneto.

8. Land as soon as practical.

Consider the use of CAPS if a safe landing at a suitable airport can not be guaranteed.

### Completion Standards

- Troubleshoots the engine roughness or partial power loss considering engine indications, environmental conditions, and engine control positions,
- Steers the aircraft towards a suitable landing airport,
- Maintains safe altitude until a glide to landing can be made,
- Continuously plans for an engine failure,
- Simulates declaring an emergency and receives priority handling and assistance from ATC if simulated conditions warrant.

### Common Errors

- Prematurely starts a descent with a partial power loss or rough engine before aircraft is within a position to glide to the airport,
- Fails to properly troubleshoot and recognize the reason for engine roughness or power loss,
- Fails to maintain aircraft control while troubleshooting engine roughness or power loss,
- Fails to contact ATC declaring an emergency and requesting priority handling, if necessary,
- Fails to determine an appropriate landing spot or to initiate a CAPS deployment.

## Loss of Oil Pressure

A loss of oil pressure is an emergency situation that typically results in a catastrophic engine failure. Immediate action by the pilot is required to steer the aircraft towards a suitable landing or CAPS deployment area. Reduce power to minimum for sustained level flight to extend engine life but preserve altitude as long as possible in preparation for an engine failure.

A rise in oil temperature due to the loss of oil pressure may or may not be seen. Do not immediately overlook a low oil pressure situation as an indication problem if oil temperature does not rise. Indication problems generally are identified by erratic and quick changes in pressure. A true loss of oil pressure is typically identified by a gradual and consistent decrease in pressure. Pilots are encouraged to monitor oil pressure during routine scanning to identify oil pressure issues early.

### Procedure

1. Oil Pressure Gauge ..... CHECK  
High oil temperature may or may not accompany low oil pressure.  
*If pressure low:*
  - a. Power..... REDUCE to minimum for sustained flight
  - b. Land as soon as possible.
  - c. Prepare for potential engine failure.
    - (1) Continually select suitable forced landing fields.
    - (2) Prepare for CAPS activation if necessary.

### Completion Standards

- Promptly investigates and determines the reason for the OIL PRESS message,
- Maintains altitude until aircraft is in a position to perform a power-off approach to landing,
- Completes the emergency checklist procedure as described in the AFM and reduces power to the minimum required for level flight,
- Adheres to applicable performance expectations for the Engine Failure in Flight Procedure if applicable.

## Common Errors

- Fails to recognize the cause of the OIL PRESS message,
- Fails to reduce power to minimum for sustained flight for a low oil pressure situation,
- Fails to recognize the severity of a low oil pressure warning,
- Fails to divert to nearest suitable airport,
- Starts descent prematurely, before the aircraft is within glide range of a suitable runway,
- Fails to consider CAPS as an off-airport landing alternative.

# Engine Fire In Flight

An engine fire in flight typically results from leaking fuel or oil in the engine compartment that comes in contact with the exhaust manifold. The engine must be shut down to remove the fuel source of the fire in effort to extinguish the fire. An emergency descent should be initiated promptly to help extinguish the fire and to accelerate altitude loss in preparation for an emergency landing or CAPS deployment. If CAPS is determined to be the best option, continue the descent until the aircraft is 2000 feet AGL, slow the aircraft within the deployment envelope, and activate CAPS. At this point, any fire should have been extinguished if the fuel was shutoff as per the emergency checklist and if the emergency descent was completed properly. But, be mindful of fire during the final descent and prepare to exit the aircraft quickly upon touchdown.

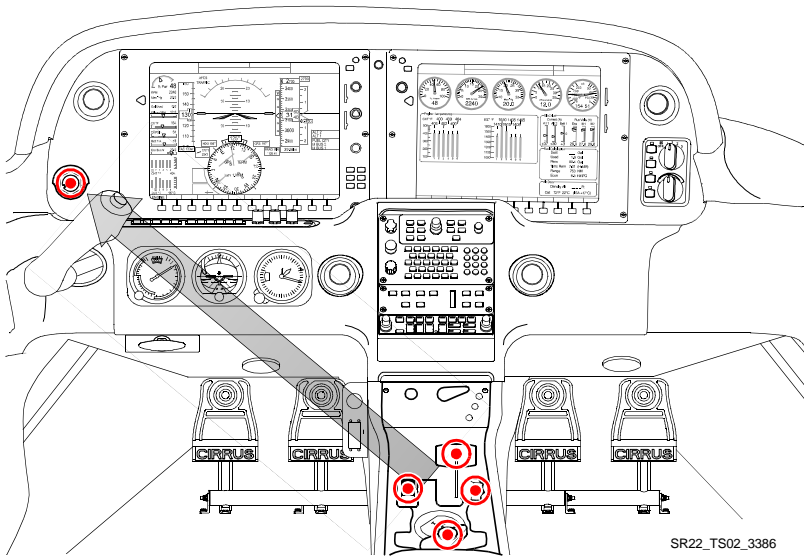

## Engine Fire In Flight

### Procedure

1. Mixture ..... CUTOFF

Placing the mixture to idle cutoff stops fuel flow at the mixture control valve located in the engine-driven fuel pump. This is the closest fuel cutoff point to the engine.

2. Fuel Pump .....OFF

Turning the auxiliary fuel pump off reduces remaining fuel pressure in the fuel system.

3. Fuel Selector.....OFF

Selecting the OFF position cuts off the fuel flow behind the engine firewall.

4. Airflow Selector .....OFF

Select OFF to reduce the chance of contaminated air from entering the cabin.

5. Power Lever ..... IDLE

Reduce the power lever to IDLE to further reduce the chance of fire and to use remaining oil pressure to increase propeller pitch.

6. Ignition Switch.....OFF

Turning the ignition switch to OFF further reduces the likelihood of combustion in the cylinders.

7. Cabin Doors .....PARTIALLY OPEN

Partially open the cabin doors to remove smoke and fumes from the cabin. Be mindful of door position when activating CAPS.

8. Land as soon as possible.

- A high probability exists that an off-airport landing will be required. Use CAPS when a safe landing is in doubt, preferably above 2000 feet AGL.

### Completion Standards

- Completes the Engine Fire checklist items from memory in a timely manner,
- Establishes an emergency descent smoothly and promptly and maintains  $V_{NO} +0/-5$  KIAS,
- Determines best course of action to recover the aircraft, considering CAPS, off-airport landing, or airport landing,
- Completes the Emergency Landing Without Engine Power checklist memory items,

- Properly executes a go-around when conditions warrant.

## **Common Errors**

- Fails to complete Engine Fire checklist memory items,
- Does not initiate emergency descent correctly and promptly if conditions warrant,
- Fails to correctly determine whether to land at an airport, land off-airport, or deploy CAPS.

## Electrical Malfunctions Overview

Cirrus aircraft are equipped with a robust, fault tolerant electrical system with redundant sources of power and protective devices. It is important for pilots to be knowledgeable of the aircraft's power generation, power distribution, indicating systems, and caution and warning systems because the aircraft's primary flight instruments rely on electrical power for operation. During flight training, multiple electrical failures will be simulated to develop and assess the pilot's knowledge of the electrical system, troubleshooting techniques, and decision making. Use the guidance in this section, coupled with the procedures detailed in the Pilot's Operating Handbook, when handling training of electrical malfunctions.

### Training Limitations

- Electrical malfunctions are not permitted in IMC or when VMC can not be maintained,
- Limit operations to 10 minutes with alternators turned off,
- Do not turn both batteries off in flight if ATC or intercom communication is necessary. Energize batteries before turning alternators back on,
- Do not turn ALT 1, ALT 2, and BATT 1 off if intercom communication is needed or if external communication is required by the instructor.
- Electrical fire should only be simulated in class E or G airspace under VFR or simulated IFR by verbally announcing the fire.

## Alternator 1 and 2 Failures

An alternator failure is recognized through the Crew Alerting System (CAS) on the Primary Flight Display. Pilots are encouraged to call up the Engine page on the Multi Function Display to verify what has failed. Then, reference the appropriate checklist for troubleshooting.

In most cases, an alternator 1 failure is recognized by the following:

- ALT 1 caution,
- Main Bus 1 voltage at approximately 24 volts and Low M Bus caution message,
- Battery 1 discharging and associated caution message.

An alternator 2 failure is recognized by and ALT 2 caution message. No other cautions or warnings are present because alternator 1 is capable of powering the remaining electrical equipment.

A single alternator failure is typically an abnormal condition, not an emergency procedure. Pilots are encouraged to follow checklist guidance when troubleshooting alternator issues. Reference the CAS checklist group for alternator troubleshooting guidance. The autopilot should be engaged to decrease pilot workload during troubleshooting efforts.

Distance remaining to destination, weather, and availability of maintenance are factors that pilots should consider when determining the best course of action with a failed alternator. The Kinds of Operation Equipment list found in section 2 of the Pilot's Operating Handbook allows flight to depart VFR day and night with a failed alternator 2. Alternator 1 is required for all flight dispatches. It is recommended to land at an airport with maintenance capabilities in the event of an alternator 1 failure to reduce aircraft down-time.

### Procedure

1. ALT 1 or 2 Circuit Breaker ..... CHECK & SET
2. ALT 1 or 2 Master Switch ..... CYCLE

Do not attempt multiple restarts if the failed alternator does not start on the initial cycle. If alternator does not reset (low A1 Current and M1 voltage):

3. ALT 1 or 2 Master Switch ..... OFF

#### **For Alternator 1 Failures:**

1. Non-Essential Bus Loads ..... REDUCE



- a. If flight conditions permit, consider shedding the following to preserve Battery 1:
  - (1) Air conditioning,
  - (2) Cabin fan,
  - (3) Landing light,
  - (4) Yaw servo,
  - (5) Convenience power (aux items plugged into armrest jack)
2. Continue flight, avoiding IMC or night flight as able (reduced power redundancy).

## Completion Standards

- Promptly recognizes and identifies the failure,
- Uses the autopilot to reduce workload,
- Calls up the appropriate checklist and follows checklist procedure as a do-list,
- Makes appropriate decisions considering external factors such as weather conditions, airspace ahead, nature of the failure, ETE to destination, etc.

## Common Errors

- Completes checklist items without reference to the checklist,
- Incorrectly identifies the cause of the failure,
- Attempts multiple circuit breaker resets,
- Fails to correctly load-shed.

## Electrical Fire (Cabin Fire In Flight)

An electrical fire or cabin fire in flight is an emergency situation requiring immediate pilot action. The pilot must turn off power sources and electrical equipment to eliminate an electrical fire. In VFR conditions, it is recommended to turn off both batteries and alternators. Reference the magnetic compass, backup airspeed indicator, backup altimeter, and outside visual reference for aircraft control.

In IMC conditions, or conditions that require flight by reference to instruments, turn off all switches except BATT 2 to preserve power to the primary flight display and backup attitude indicator. There is a high probability that the source of fire will be eliminated. Turn off BATT 2 if the fire continues to burn. Activate CAPS if controlled flight can not be maintained.

### Procedure

1. Oxygen System (if applicable) .....OFF

Turn off the oxygen system, if applicable, to reduce the chance of a severe fire in the cabin.

2. Bat-Alt Master Switches ..... OFF, AS REQ'D

In VFR, turn off all battery and alternator switches. When flight by reference to instruments is required, leave BATT 2 ON.

3. Fire Extinguisher ..... ACTIVATE

• Note •

*If airflow is not sufficient to clear smoke or fumes from cabin:*

4. Cabin Doors ..... PARTIALLY OPEN

5. Avionics Power Switch .....OFF

6. All other switches ..... OFF

7. Land as soon as possible.

*It is not possible to maintain aircraft control in IMC without electrical power to the PFD and/or backup attitude indicator. Activate CAPS if aircraft control can not be maintained.*

8. Air Conditioner (if installed) .....OFF

9. Airflow Selector ..... OFF

10. Bat-Alt Master Switches ..... ON

11. Avionics Power Switch .....ON
12. Required Systems .....ACTIVATE one at a time
13. Temperature Selector..... COLD
14. Vent Selector..... FEET/PANEL/DEFROST POSITION
15. Airflow Selector .....SET AIRFLOW TO MAXIMUM
16. Panel Eyeball Outlets..... OPEN
17. Land as soon as possible.

### **Completion Standards**

- Recognizes the severity of the electrical fire and responds by completing the Cabin Fire in Flight checklist procedures,
- Takes appropriate action to eliminate cabin smoke and fumes,
- Diverts to nearest suitable airport for approach and landing, or
- Simulates CAPS deployment if aircraft control cannot be maintained,
- Makes appropriate decisions considering all external factors.

### **Common Errors**

- Fails to complete Cabin Fire in Flight checklist memory items in a timely fashion,
- Fails to consider VMC or IMC when turning off switches to attempt to eliminate the fire,
- Fails to land the aircraft as soon as possible,
- Fails to recognize if/when aircraft attitude cannot be maintained in IMC,
- Fails to maintain positive aircraft control due to high workloads and increased stress.

## Integrated Avionics Malfunctions Overview

Cirrus Perspective avionics are robust, fault tolerant, and redundant. Although a component failure is highly unlikely, it is important to train pilots how to handle various avionics-related failures. Focus ground and flight training on the following objectives:

- Ability to maintain aircraft control,
- Proper identification of the failed component,
- Knowledge of other avionics equipment affected by the failed equipment, primarily the autopilot,
- Knowledge of information, features, or functions that are rendered inoperative by the failed equipment,
- Proper use of backup instrumentation,
- Knowledge and use of ATC services available to reduce workload.

The following table is a useful tool that describes how autopilot modes are affected by various Perspective component failures. An 'X' in the

| Failure                | ROL | HDG            | NAV | APR | LVL            | PIT | IAS VS ALT | GS GP | VNAV |
|------------------------|-----|----------------|-----|-----|----------------|-----|------------|-------|------|
| PFD Screen             | X   | X              | X   | X   | X              | X   | X          | X     | X    |
| PFD Power <sup>a</sup> | X   | X              | X   | X   | X              | X   | X          | X     | X    |
| ADC <sup>b</sup>       | X   | X <sup>c</sup> | X   | X   | X <sup>d</sup> | X   |            |       |      |
| Single AHRS            | X   | X              | X   | X   | X              | X   | X          | X     | X    |
| Dual AHRS              |     |                |     |     |                |     |            |       |      |
| GIA 1 <sup>e</sup>     | X   | X              | X   | X   | X              | X   | X          | X     | X    |
| GIA 2                  | X   | X              | X   | X   | X              | X   | X          | X     | X    |

- The autopilot will revert to ROL mode when the PFD power is failed. All lateral modes may be reselected and used.
- Assumes system with 1 ADC or 2 failed ADCs. All modes of the AP will be available with a single ADC failure in a dual ADC configuration.
- Turns to heading or to intercept a course will be made at half standard rate.
- Only the wings level mode will be available with a ADC failure. Use PIT mode or hand fly for vertical control.
- The autopilot will revert to ROL and PIT mode upon failure. All other modes may be reselected

box means the autopilot mode will be available during the respective equipment failure.

## Training Limitations

- Limit avionics malfunctions to VMC and when the flight can continue in VMC to landing,

- Note •

It is permissible to fly in IMC while in reversionary mode as long as both the PFD and MFD screens are visible and charts and checklists are available through other sources.

- Restore power to failed equipment before entering IMC,
- Ensure ATC communication is maintained as required during failures,
- Do not power down the Air Data Computer when the altitude reporting (Mode C) capability of the transponder is required by regulations or necessary for safe flight,
- Limit failures to areas of low traffic congestion and instructor workload.

## PFD Display Failure and Reversionary Mode

It is possible to enter and exit reversionary mode in flight by pressing the reversionary mode button.

Although all autopilot modes and all flight and navigation instruments are available in reversionary mode, pilots must be aware that certain MFD information, features, and functions are not available in reversionary mode.

The following information and resources will not be available while in reversionary mode:

- Approach charts,
- Checklists,
- Detailed airport and frequency information,
- Most satellite weather products
- Lean assist feature,
- TKS tank selection control,

The following information and resources will not be available with a PFD power loss:

- Baro setting unchangeable with PFD power loss; use backup altimeter,
- Com volume and squelch adjustment,
- Loss of Com 1 and Nav 1 control; Com 1 defaults to 121.5,
- Note •

The autopilot will revert to roll mode when the PFD is powered down. It is possible to re-engage any mode of the autopilot.

### Procedure

1. Display Backup ..... ACTIVATE  
Press the red button between the MFD and PFD to activate the display backup if the primary instruments are not displayed on the MFD. Use backup charts, checklists, and airport information as required.
2. Land as soon as practical.

### Completion Standards

- Recognizes PFD failure and selects reversionary mode,

- Uses the correct modes of the autopilot and/or hand-flies to maintain aircraft control within applicable private or instrument practical test standards,
- Determines the best course of action considering external factors, such as weather, ATC services available, airport services, level of workload, and pilot proficiency,
- Utilizes backup charts and checklists,

### **Common Errors**

- Fails to carry backup charting or checklist resources,
- Fails to recognize the autopilot change to roll mode,
- Inability to control the aircraft while scanning primary instruments on the MFD,
- Fails to recognize and account for the loss of Com 1.

## Air Data Computer Failure

An air data failure could be caused by faulty input information. Look for faulty indications on the standby airspeed and altimeter to verify. Troubleshoot an ADC failure by resetting the ADC circuit breaker(s), switching to the alternate static source, and turning pitot heat on. Adjust the instrument scan to include the backup airspeed and altimeter.

The following information will not be available during an air data failure with a single ADC:

- PFD airspeed,
- PFD altitude,
- PFD vertical speed,
- Percent power, except SR22Ts,
- OAT,
- Wind information,
- TAS,
- Transponder Mode C (single ADC).

Pitch control is not available when the LVL autopilot mode is selected. The lateral ROL mode, or wing leveler, is available. Pilots may hand-fly or use PIT mode of the autopilot to maintain vertical control.

### Procedure

1. ADC Circuit Breaker..... SET

If open, reset (close) circuit breaker.

2. Revert to Standby Instruments (Altitude, Airspeed).

Verify the standby instruments are working properly by maneuvering the aircraft slightly and looking for the expected change. i.e. enter a slight climb and verify that airspeed decreases and altitude increases. Select the alternate static source and verify pitot heat is on.

3. Land as soon as practical.

### Completion Standards

- Correctly identifies the ADC failure,
- Completes the Air Data Computer Failure checklist procedure,



- Checks standby airspeed and altimeter indications and selects alternate static source and pitot heat as necessary,
- Uses the correct modes of the autopilot or hand-flies to maintain aircraft control within applicable private or instrument practical test standards.

## **Common Errors**

- Fails to recognize affected modes of the autopilot,
- Fails to control the aircraft airspeed and altitude within applicable standards,
- Fails to notify ATC and request assistance as necessary,
- Determines the best course of action considering external factors such as: weather, ATC services available, airport services, level of workload, and pilot proficiency.

## AHRS Failure

In order to lose all AHRS information, aircraft equipped with dual attitude heading and reference systems would need to have a dual AHRS failure. Dual AHRS equipped aircraft will automatically switch from one AHRS unit to the other if performance degradation in one AHRS is recognized by the internal system monitoring. A dual AHRS failure, or single AHRS failure in aircraft equipped with one AHRS, can be recognized by the following indications:

- Loss of Synthetic Vision or horizon indications,
- Red “X” over the attitude indicator,
- “ATTITUDE FAIL” annunciator over the attitude indicator,
- Loss of heading information,
- Red “X” over the heading information,
- CDI will remain in the vertical position and provide left and right of course deviation indications.

It is important to note that the PFD CDI needle will be oriented straight up, and still display accurate course deviations for GPS and LOC courses. GS information will also be available while conducting ILS approaches. TRK and DTK can be displayed on the MFD user-defined data field for reference. Pitch and roll information is obtained through outside visual reference or the backup attitude indicator and heading information is obtained through the magnetic compass and/or ground track.

The GFC 700 autopilot will not be available during a dual AHRS failure. See the Autopilot Failure Modes table for more information.

### Procedure

1. Verify Avionics System has switched to functioning AHRS

If not, manually switch to functioning AHRS and attempt to bring failed AHRS back on-line:

2. Failed AHRS Circuit Breaker..... SET

If open, reset (close) circuit breaker. If circuit breaker opens again, do not reset.

3. Be prepared to revert to Standby Instruments (attitude / heading).

Left and right course indications will be available on the HSI. Refer to the magnetic compass for heading information.

## Completion Standards

- Recognizes the failed equipment, ensures that the system switches the sensor information to AHRS 2 if available,
- Informs the instructor or ATC of failure, assistance needed, and remaining navigation capabilities,
- Determines the best course of action considering external factors such as the weather, ATC services available, airport services, level of workload, and pilot proficiency,
- Maintains aircraft control at all times within applicable practical test standards for the procedure or phase of flight being performed.

## Common Errors

- Fails to maintain aircraft control within applicable practical test standards,
- Fails to include backup attitude indicator in instrument scan,
- Fails to include TRK and/or compass heading in scan,
- Over-controls pitch and roll,
- Neglects to inform ATC or the instructor of the failure and requested assistance,
- Unable to adjust to a partial panel scan,
- Loses aircraft control, requiring instructor intervention, and fails to consider a CAPS deployment.

## GIA Failure

The Garmin Integrated Avionics (GIA) 1 powers COM 1, NAV 1, and GPS 1. GIA 2 powers COM 2, NAV 2, and GPS 2. In the event of a failure, the respective COM and NAV will be replaced with a red 'x' while the COM frequency defaults to 121.5. Before simulating this failure by pulling the GIA 1 or 2 circuit breakers, note the frequency being used in the respective COM. It is very common for pilots to overlook the loss of COM or NAV and fail to re-tune the active frequency in COM 2. Be sure to highlight the change and reset the frequency as necessary for uninterrupted communication with ATC or other traffic.

### Procedure

1. Communication ..... USE COM 1 or 2  
Use COM 1 if GIA 2 fails or use COM 2 if GIA 1 fails.
2. Navigation ..... USE VLOC 2 if applicable
3. Land as soon as practical.

### Completion Standards

- Recognizes the failed equipment and resets communication frequencies as required,
- Re-engages the desired mode of the autopilot if necessary,
- Determines the best course of action considering external factors such as weather, ATC services available, airport services, level of workload, and pilot proficiency.

### Common Errors

- Fails to recognize and change COM frequencies as required,
- Fails to recognize the autopilot mode switch from NAV to ROL.

## Loss of GPS Integrity

A loss of GPS integrity is an abnormal situation that requires the pilot to reference alternative forms of navigation. Pilots flying IFR should notify ATC immediately of the reduced navigational capabilities. It may be possible for ATC to provide radar vectors but expect to join victor airways to the intended destination. Also, consider the type of approaches available at the destination airport. A GPS approach will not be possible with a loss of GPS integrity.

Losing GPS integrity may have more impact when flying VFR due to the lack of ATC services available compared to when flying on an IFR flight plan. The 'dead reckoning' mode of the GPS will be helpful for maintaining situational awareness but use this feature with caution. VFR pilots are encouraged to switch navigation sources to VOR and navigate on victor airways to the final destination.

### Completion Standards

- Recognizes failure and selects an alternate form of navigation,
- Advises ATC and requests alternate routing if necessary,
- Determines the best course of action considering external factors such as weather, ATC services available, airport services, level of workload, and pilot proficiency.

### Common Errors

- Neglects to notify ATC of failure and request assistance as necessary,
- Loses situational awareness.

## Other Emergency Procedures Overview

The emergency and abnormal procedures discussed in this section are normally the result of the pilot making poor decisions, inadequate planning, or the pilot lacking fundamental skills. These procedures are practiced during flight training with the objective of developing decision making skills to avoid these situations.

### Unusual Attitudes

Unusual attitudes are most likely to be encountered by pilots who lack instrument skills, VFR pilots who inadvertently entered IMC, or pilots experiencing an abnormally high workload. Pilots who have entered an unusual attitude have temporarily lost aircraft control or failed to maintain aircraft control. At the moment of recognition, the pilot must make an immediate decision if the aircraft can be recovered using traditional recovery techniques such as: a manual recovery, engaging the autopilot (if within limitations), or activating CAPS. Immediate action by the pilot is required to recover the aircraft regardless of which recovery method is chosen.

It is important to note that pilots who have lost aircraft control may be disoriented beyond the point where traditional, hand flown recovery techniques are effective. CAPS activation may be the best recovery option available.

Preventing unusual attitudes is the best course of action. Pilots who maintain high levels of IFR proficiency and VFR pilots who remain clear of IMC conditions are less likely to enter an unusual attitude. Frequent recurrent training is helpful, but it is also helpful to frequently fly in IFR in order to maintain avionics programming proficiency and familiarity with IFR communications and procedures.

Pilots are encouraged to use the autopilot during periods of high workload, but should not become overly-dependent on the autopilot for aircraft control.

### Training Limitations

- Minimum recovery altitude is 1500 feet AGL,
- Do not exceed 60 degrees of bank or 30 degrees of pitch up or down,
- Initiate recovery before  $V_{NE}$  is exceeded,
- Conduct maneuver in VMC only,

## Recovery (Training)

- *Nose high*: add power while reducing pitch to maintain airspeed and level the wings,
- *Nose low*: reduce power while leveling the wings and increase pitch after wings are level to stop the descent.

## Completion Standards

- Promptly recognizes the unusual attitude and applies corrective actions as described above and in the Instrument Flying Handbook,
- Engages autopilot once the aircraft is recovered,
- Returns the aircraft to the previously assigned heading or course, and/or altitude,
- Regains situational awareness.

## Common Errors

- Fails to scan and interpret flight attitude quickly,
- Fails to add power from a nose low unusual attitude and loses significant airspeed and possibly aircraft control,
- Fails to return aircraft to previously assigned heading or course, and/or altitude,

## Inadvertent Flight into IMC

Inadvertent flight into IMC by VFR and IFR rated pilots is a major contributing cause of fatal accidents. Pilots that fail to brief and interpret weather conditions or intentionally fly below low cloud bases are at the highest risk for unintentional flight into IMC.

Although prevention is the best way to avoid inadvertent flight into IMC, pilots must be able to maintain aircraft control while safely exiting IMC. The autopilot is a great tool for assisting pilots out of IMC. However, the pilot must be capable of using the proper autopilot modes to exit the conditions. Returning to the previous VMC is usually the best option. However, some situations will require alternative solutions to exit IMC. This is particularly true while scud running close to the ground and/or obstacles. Scud running close to the ground increases the risk for a CFIT or loss of control accident, which are typically fatal.

### Training Limitations

- Abide by all legal altitude restrictions,
- Do not enter IMC unless on an IFR clearance,
- Flight below 500 feet AGL other than for takeoff or landing is not recommended,
- Do not put the aircraft on a direct collision course with obstacles or terrain other than normal descent to landing.

### Completion Standards

- Maintains aircraft control within applicable practical test standards,
- Uses autopilot correctly to assist in exiting IMC,
- Promptly and correctly changes heading and/or altitude to exit conditions,
- Seeks ATC assistance if necessary,
- Maintains situational awareness.

### Common Errors

- Fails to maintain aircraft control by focusing on instrument scan,
- Fails to consider weather patterns when planning the exit strategy,



- Does not initiate a prompt exit strategy,
- Continues to climb into IMC even at safe altitudes and expects to escape by turning around.

## Flap Malfunction

A malfunction in the flap system typically results in the flaps failing to extend prior to approach or landing. Pilots must be aware of the additional landing distance required due to the higher stall and approach speeds. Pilots are encouraged to select a landing runway that is at least 5000 feet long for 0% flap landings. A diversion may be necessary if the runway at the intended destination is not adequate for a safe landing.

Pilots are encouraged to practice reduced flap landings during initial and recurrent training.

### Training Limitations

- Reset the circuit breaker before conducting takeoff or landing practice,
- Minimum runway length is 5000 feet for zero flap takeoff and landing practice,
- Flaps may be failed in IMC as long as the destination ceiling and visibility is greater than 1000 feet AGL and 3 SM.

### Completion Standards

- Recognizes the failure after attempting to extend 50% flaps,
- Adjusts speed as necessary to perform a zero flap landing,
- Considers landing distance and selects an appropriate runway for a safe landing,
- Adheres to applicable landing completion standards.

### Common Errors

- Fails to recognize the flap malfunction and continues landing unknowingly,
- Knowingly attempts a landing on a short runway with inadequate safety margins,
- Lacks the skills to perform a zero flap landing within applicable completion standards.

## Oxygen System Malfunction

All pilots flying an oxygen and/or turbo equipped Cirrus aircraft are encouraged to attend hypoxia training every 5 years. Information about facilities that offer this training can be found on the Cirrus Training Portal. Be cognizant of hypoxia signs and symptoms and continuously monitor oxygen saturation levels with a pulse oximeter when operating at altitudes that require the use of supplemental oxygen.

It is critical to ensure adequate oxygen is available for the intended flight considering altitude and passengers. Careful preflight of all regulators, masks, cannulas, oxygen flow, hoses, and connections is required.

An O<sub>2</sub> malfunction at high altitude is an emergency situation requiring immediate and decisive action by the pilot. If supplemental oxygen is not available at high altitude, an emergency descent must be initiated. Consider using the autopilot in IAS mode set to V<sub>NO</sub> with the altitude bug set to 10,000 feet MSL, or higher if terrain dictates.

### • WARNING •

Intentionally removing supplemental oxygen at or above altitudes where supplemental oxygen is required by regulation is reckless and unsafe. The supplemental oxygen system will remain on during all O<sub>2</sub> malfunction scenarios. These scenarios are intended to teach pilots how to respond to various oxygen failures, not to demonstrate hypoxia signs, symptoms, and recovery.

## Training Limitations

- Malfunction limited to VFR in airspace and terrain that allows an emergency descent to a minimum of 12,500 feet MSL,
- Oxygen system and masks or cannulas will remain on at all altitudes that require supplemental oxygen.

## Completion Standards

- Promptly responds to the malfunction and initiates an emergency descent to a safe altitude,
- Declares an emergency when workload permits and coordinates with ATC as required,

- Recognizes signs and symptoms of hypoxia in passengers and responds accordingly.

## **Common Errors**

- Does not understand the severity of an oxygen system malfunction at high altitude,
- Fails to perform an emergency descent as described in the emergency descent completion standards.

## Power Lever Linkage Failure

A stuck throttle results from a linkage failure between the power lever and the throttle plate. The power may be at a high or low power setting. Individual circumstances dictate the proper reaction by the pilot.

When the power is stuck low and the aircraft is unable to sustain level flight, the pilot should establish the aircraft at best glide speed and prepare for an emergency landing. CAPS should be considered and activated above 2,000 feet AGL when the successful outcome of a forced landing is in doubt.

A stuck throttle with a high power setting will require the pilot to perform a power-off landing. The pilot should position the aircraft within safe gliding distance from the airport, a runway greater than 5,000 feet is recommended, and then shut the engine off with the mixture control and establish best glide. The pilot may enrichen the mixture to restart the engine if it appears the aircraft will come up short to the runway.

Pilots who are not confident in their ability to perform this procedure should consider CAPS as an alternative to the power-off landing.

### Procedure

1. Power Lever Movement..... VERIFY  
Sweep the power lever slowly to determine if any control remains.
2. Power .....SET if able
3. Flaps ..... SET if needed  
With a high power setting, consider decreasing airspeed by increasing the aircraft's pitch to flap speeds. Set flaps as desired and continue descent.
4. Mixture ..... AS REQUIRED (full rich to cut-off)  
To perform a landing with a stuck throttle, the engine will need to be shut off via the mixture control. It is best to position the aircraft within safe gliding distance before turning the engine off.
5. Land as soon as possible.

A stuck throttle should be treated as an emergency situation. Inform ATC of situation and request assistance and priority handling as necessary. Be prepared for a power-off landing.

## Completion Standards

- For takeoff scenario, promptly reduces throttle to idle and applies brakes as required to stop the aircraft on the runway,
- For landing scenario, simulates notifying ATC of emergency and requests assistance as necessary,
- For landing scenario, reduces risk by selecting a larger runway,
- For landing scenario, puts the aircraft into a position where a stabilized approach to a power-off landing can be accomplished,
- For landing scenario, considers methods of extending glide distance or performing a go-around if necessary.

## Common Errors

- Does not consider engine shutdown and power-off approach for resolving scenario,
- Fails to abort takeoff promptly,
- Fails to execute a power-off approach within applicable completion standards.

## Loss of Brake Pressure

Pilots are encouraged to check brakes before taxi and during the descent checklist during each flight operation as detailed in the normal procedures checklist. In the event of a loss of brake pressure during taxi, the engine should be shutdown before the aircraft comes into collision hazard with objects on the ground. The aircraft should be towed and repaired prior to flight or self-propelled movement on the ground.

If brake pressure is lost during flight, select a wide runway that is at least 5,000 feet in length. Notify ATC of the failure to ensure landing separation is accounted for. Touchdown close to the approach end of the runway with minimum speed. For a single brake failure, land on the side of runway corresponding to the failed brake. Use rudder to steer and counteract the forces of the remaining brake. Discontinue braking when rudder authority no longer over controls the single remaining brake.

### Training Limitations

- Discontinue scenario and apply brake pressure as necessary to avoid collision or runway overrun,
- Practice no-brake landings at a runway that is at least 5,000 feet,
- Limit failure to VMC.

### Completion Standards

- For taxi scenario, adheres to the Brake Failure During Taxi checklist procedures as necessary,
- For taxi scenario, shuts the engine down and stop the aircraft forward movement when necessary,
- For landing scenario, selects an appropriate runway for performing a no-brake landing,
- For landing scenario, references the Landing with Failed Brakes checklist procedure,
- For landing scenario, simulates informing ATC of malfunction and requests assistance as necessary,
- Lands on correct side of the runway for a single brake failure and maintains directional control.

## **Common Errors**

- For taxi scenario, fails to shut engine down and collides with ground structures,
- For landing scenario, fails to pump the brakes to restore pressure,
- For landing scenarios, fails to select an adequate runway,
- Fails to land on correct side of the runway for a single brake failure.



## Open Door

Doors that close hard or open in flight require service. When properly adjusted, Cirrus doors will remain closed and are easy to operate. It is recommended to close the passenger door from outside the aircraft when flying with infrequent flyers. Always check the upper and lower latches of each door before departure and listen for increased cabin noise during the engine run-up to identify an improperly shut door.

Although an open door is undesirable due to the increase in cabin noise, possible decrease in temperature, and possible precipitation in the cabin, the aircraft handling characteristics are unchanged. It is not possible to close the door in flight due to the aerodynamic forces. It is recommended to land and stop the aircraft to close the door if the door opens in flight or was left open during departure. This is not an emergency landing. Pilots should use normal power settings, speeds, and aircraft configuration for landing. Do not become overly distracted by the open door and focus on maintaining aircraft control.

### Completion Standards

- Maintains aircraft control,
- Communicates intentions to ATC and returns for a landing,
- Listens for signs of an open door during run-up and early in the takeoff roll,
- Aborts takeoff only when sufficient runway remains for stopping without excessive brake pressure.

### Common Errors

- Becomes preoccupied with open door and loses focus on primary pilot responsibilities,
- Attempts to slow and close door in flight.
-

Intentionally Left Blank

# Section 5

## Maneuvers

### General

Follow these guidelines for set up and execution of the following maneuvers. During these maneuvers, pilots should be alert to available forced landing areas. The area chosen should be clear of any obstacles or terrain and away from communities, livestock, or groups of people to prevent possible annoyance or hazards to others.

Reference the Airplane Flying Handbook FAA-H-8083-3a for more information.

### Minimum Recovery Altitude

- Performance maneuvers, slow flight, and stalls should be performed with a minimum recovery altitude of 1,500 feet AGL,
- Ground reference maneuvers should be performed at 1,000 feet AGL or applicable traffic pattern altitude.

### Mixture Control

For all maneuvering flight, the mixture should be set to allow maximum power if needed.

- SR20 - Set mixture full rich
- SR22 - Set mixture per the Max Power Fuel Flow placard or the top of the green arc on the fuel flow gauge
- SR22TN - Set mixture full rich
- SR22T - Set mixture full rich

## Steep Turns (Private and Commercial)

Enter this maneuver at 120 KIAS by smoothly banking the aircraft to 45 degrees (Private) or 50 degrees (Commercial) and simultaneously adding back pressure to maintain altitude. Maintain coordination with rudder. Additional power may be necessary to maintain airspeed. Continue the turn for 360 degrees. Start the roll out approximately 10 degrees before completing the full turn and simultaneously release back pressure. Reduce any power that was added during the maneuver.

### Limitations

- Minimum recovery altitude: 1,500 feet AGL,
- VMC only.

### Execution

- Execute clearing turns,
- Airspeed 120 KIAS,
  - SR20 - 60% Power / 21" MP (approximately),
  - SR22 - 30% Power / 18" MP (approximately),
  - SR22TN - 55% Power / 20" MP (approximately),
  - SR22T - 50% Power / 18" MP (approximately).
- Bank Angle 45° (Private) or 50° (Commercial).

### Recovery

- Smoothly roll out on desired heading while relaxing elevator back pressure to maintain altitude,
- Reduce power to maintain airspeed,
- Continue flight as desired.

### Completion Standards

- Exhibits knowledge of the elements related to this maneuver and complies with limitations, execution, and recovery procedures described in this manual,
- Maintains altitude +/-100 feet, airspeed +/-10 KIAS, bank angle +/- 5 degrees, and rolls out on entry heading +/-10 degrees,
- Maintains 45 degree (private), or 50 degrees (commercial),

- Divides attention between outside visual reference and instrument scan (VMC),
- Maintains aircraft coordination during maneuver,
- Smoothly rolls into opposite direction turn as requested by instructor.

### **Common Errors**

- Adds excessive elevator back pressure while rolling into bank causing the aircraft to climb and lose airspeed,
- Over-banks or excessively changes angle of bank, causing altitude and airspeed fluctuations,
- Fails to reduce back pressure and/or reduce power-on maneuver rollout causing the aircraft to climb and/or accelerate,
- Uses abrupt and excessive control inputs.

## Steep Spirals (Commercial)

A steep spiral is a constant gliding turn, during which a constant radius around a point on the ground is maintained, similar to the turns around a point maneuver. The radius should be such that the steepest bank will not exceed 60 degrees. Start the maneuver at 3,000 feet AGL or higher so that the spiral may be continued through a series of at least three 360-degree turns.

Operating the engine at idle speed for a prolonged period during the glide may result in excessive engine cooling or spark plug fouling. The engine should be cleared every 1,000 feet by briefly advancing the throttle to normal cruise power, while adjusting the pitch attitude to maintain a constant airspeed. Preferably, this should be done while headed into the wind to minimize any variation in groundspeed and radius of turn.

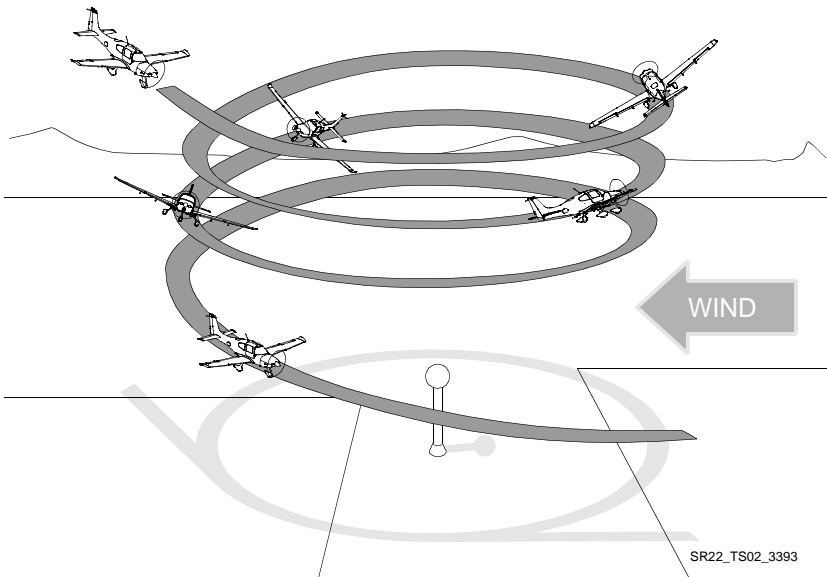

**Steep Spirals**

### Limitations

- Minimum recovery altitude 500 feet AGL unless safety or regulations dictate higher, or if a stabilized approach to landing can be made,
- Limit bank angle to 60 degrees,

- Limited to VMC.

## Execution

- Reduce throttle to idle,
- Adjust aircraft pitch to maintain altitude until  $V_G$  is reached,
- Lower nose to maintain  $V_G$  over the selected reference point,
- Adjust bank angle as necessary to fly a constant radius over selected reference point.
- Clear engine every 1,000 feet,
- Complete a minimum of at least three, 360-degree turns.

## Recovery

- Add power as necessary and climb to desired altitude, or
- Continue landing if a stabilized approach to landing can be maintained.

## Completion Standards

- Selects an altitude sufficient to continue through a series of at least three 360-degree turns,
- Selects a suitable ground reference point,
- Applies wind-drift correction to track a constant radius circle around the selected reference point with bank not to exceed 60 degrees,
- Divides attention between airplane control and ground track, while maintaining coordinated flight,
- Maintains  $V_G$  +/-10 KIAS, rolls out toward object or specified heading +/- 10 degrees,
- Positions aircraft for a stabilized approach to landing and completes a power-off landing within applicable completion standards.

## Common Errors

- Fails to maintain constant airspeed resulting in ground speed changes and difficulty maintaining a constant radius,
- Fails to decrease bank angle sufficiently on the upwind side to prevent getting blown over the reference point,

- Fails to account for wind changes throughout the descent,
- Mis-judges descent rate and fails to position the aircraft for a stabilized approach to landing if a landing was attempted.



## Chandelle (Commercial)

A chandelle is a maximum performance climbing turn beginning from approximately straight-and-level flight, and ending at the completion of a precise 180 degree turn in a wings-level, nose-high attitude at the minimum controllable airspeed. The maneuver demands that the maximum flight performance of the airplane be obtained; the airplane should gain the most altitude possible for a given degree of bank and power setting without stalling.

Since numerous atmospheric variables beyond control of the pilot will affect the specific amount of altitude gained, the quality of the performance of the maneuver is not judged solely on the altitude gain, but by the pilot's overall proficiency as it pertains to climb performance for the power and bank combination used, and to the elements of piloting skill demonstrated.

Prior to starting a chandelle, the flaps should be in the UP position, power set for 120 KIAS, and the airspace behind and above clear of other air traffic. The maneuver should be entered from straight-and-level flight at 120 KIAS. After the appropriate airspeed and power setting have been established, the chandelle is started by smoothly entering a coordinated turn with an angle of bank appropriate for the airplane being flown. Increase to full power as the climb is initiated.

Normally, this angle of bank should not exceed approximately 30 degrees. After the appropriate bank is established, a climbing turn should be started by smoothly applying back-elevator pressure to increase the pitch attitude at a constant rate and to attain the highest pitch attitude as 90 degrees of the turn is completed. Apply rudder inputs to maintain coordinated flight throughout the maneuver.

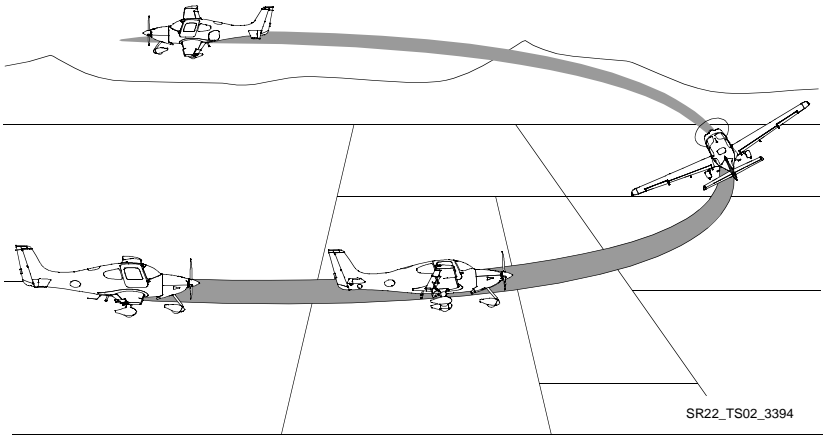

## Chandelle

### Limitations

- Minimum recovery altitude 1,500 feet AGL
- Limited to VMC.

### Execution

- Clear area around and above the aircraft,
- Maintain and note heading,
- Establish level flight at 120 KIAS,
  - SR20 - 60% Power / 21" MP (approximately),
  - SR22 - 30% Power / 18" MP (approximately),
  - SR22TN - 55% Power / 20" MP (approximately),
  - SR22T - 50% Power / 18" MP (approximately).
- Enter coordinated 30 degree level turn,
- Increase pitch at a constant rate to achieve max pitch halfway through the 180-degree turn while simultaneously adding full power,

- At the 90-degree point in the turn, maintain maximum pitch attitude while decreasing angle of bank at a constant rate to roll out wings level 180-degrees from starting heading,
- Hold the maximum pitch attitude momentarily at the 180-degree point, then reduce pitch to maintain level flight.

## Recovery

- Reduce power to normal cruise power setting once aircraft has accelerated as desired.

## Completion Standards

- Starts and completes maneuver higher than 1,500 feet AGL,
- Enters the maneuver at 120 KIAS with flaps UP,
- Establishes a 30-degree left or right turn,
- Simultaneously applies power and pitch to maintain a smooth, coordinated climbing turn to the 90-degree point, with a constant bank angle,
- Begins a coordinated constant rate rollout from the 90-degree point to the 180-degree point maintaining full power and a constant pitch attitude,
- Completes rollout at the 180-degree point +/-10 degrees, just above a stall airspeed, and maintaining that airspeed momentarily while avoiding a stall,
- Resumes straight-and-level flight with a minimum loss of altitude.

## Common Errors

- Establishes a maximum pitch that is too great, resulting in a stall condition,
- Fails to maintain coordination throughout maneuver,
- Fails to maintain a constant rate of pitch or bank changes during the appropriate phases of the maneuver,
- Fails to divide attention and look outside at visual reference points.

## Lazy Eights (Commercial)

The lazy eight is a maneuver designed to develop perfect coordination of controls through a wide range of airspeeds and altitudes so that certain accuracy points are reached with planned attitude and airspeed. In its execution, the dive, climb, and turn are all combined, and the combinations are varied and applied throughout the performance range of the airplane. It is the only standard flight training maneuver during which at no time do the forces on the controls remain constant.

The lazy eight as a training maneuver has great value since constantly varying forces and attitudes are required. These forces must be constantly coordinated, due not only to the changing combinations of banks, dives, and climbs, but also to the constantly varying airspeed. The maneuver helps develop subconscious feel, planning, orientation, coordination, and speed sense. It is not possible to do a lazy eight mechanically, because the control pressures required for perfect coordination are never exactly the same.

A lazy eight consists of two 180-degree turns, in opposite directions, while making a climb and a descent in a symmetrical pattern during each of the turns. At no time throughout the lazy eight is the airplane flown straight and level; instead, it is rolled directly from one bank to the other with the wings level only at the moment the turn is reversed at the completion of each 180-degree change in heading. As an aid to making symmetrical loops of the "eight" during each turn, prominent reference points should be selected on the horizon. The reference points selected should be 45-degrees, 90-degrees, and 135-degrees from the direction in which the maneuver is begun.

Prior to performing a lazy eight, the airspace behind and above should be clear of other air traffic. The maneuver should be entered from straight-and-level flight at 120 KIAS. Power remains constant throughout the maneuver.

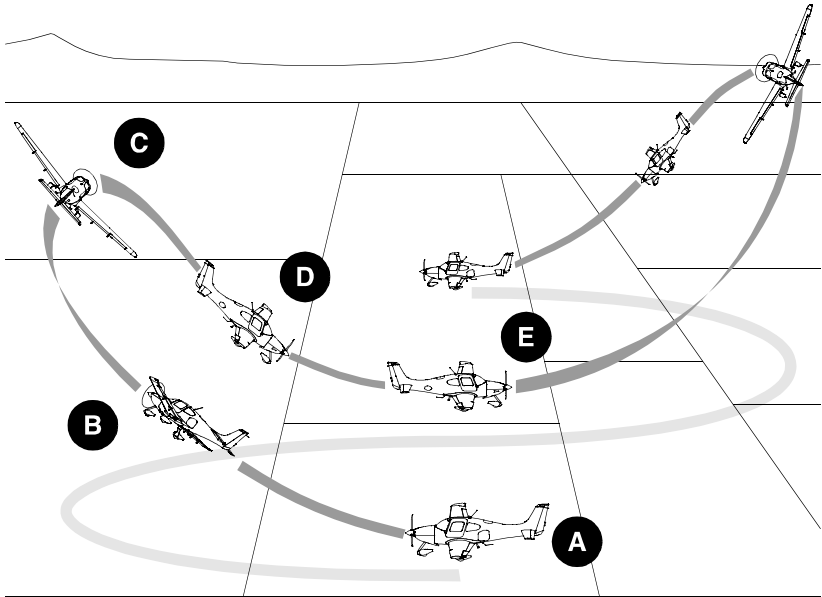

- A** ENTRY:  
1. LEVEL FLIGHT  
2. MANEUVERING OR CRUISE SPEED WHICHEVER IS LESS OR MANUFACTURER'S RECOMMENDED SPEED

- B** 45° POINT:  
1. MAX. PITCH-UP ALTITUDE  
2. BANK 15° (APPROX.)

- C** 90° POINT:  
1. BANK APPROX 30°  
2. MINIMUM SPEED  
3. MAXIMUM ALTITUDE  
4. LEVEL PITCH ATTITUDE

- D** 135° POINT:  
1. MAX. PITCH-DOWN  
2. BANK 15° (APPROX.)

- E** 180° POINT:  
1. LEVEL FLIGHT  
2. ENTRY AIRSPEED  
3. ALTITUDE SAME AS ENTRY ALTITUDE

SR22\_TS02\_3392

## Lazy Eights

### Limitations

- Minimum recovery altitude 1,500 feet AGL,
- Limited to VMC.

### Execution

- Clear area around aircraft,
- Flaps UP,
- Establish level flight at 120 KIAS,

- SR20 - 60% Power / 21" MP (approximately),
  - SR22 - 30% Power / 18" MP (approximately),
  - SR22TN - 55% Power / 20" MP (approximately),
  - SR22T - 50% Power / 18" MP (approximately).
- Control the aircraft to achieve the following throughout the maneuver,
    - At the 45-degree reference, maximum pitch up attitude with approximately 15 degrees of bank,
    - At the 90-degree reference, maximum bank of 30 degrees with level pitch,
    - At the 135-degree reference, maximum pitch down attitude with approximately 15 degrees of bank,
    - At the 180-degree point, momentary level pitch and bank as the turn direction is changed,
    - Proper coordination,
    - Constantly changing pitch and roll rates.

## Recovery

- Apply power as necessary to resume normal flight.

## Completion Standards

- Establishes the recommended entry configuration, power, and airspeed,
- Maintains altitude tolerance at 180-degree points, +/-100 feet from entry altitude,
- Maintains airspeed tolerance at the 180-degree point, +/-10 KIAS from entry airspeed,
- Maintains heading tolerance at the 180-degree point, +/- 10 degrees,
- Continues the maneuver through the number of symmetrical loops specified and resumes straight and level flight.

## Common Errors

- Rushes through maneuver and requires non-constant rates of pitch or roll change to match desired reference points,
- Fails to monitor area for other traffic during maneuver,

- Uses erratic or rough control inputs, usually caused by attempts to counteract poor planning.

## Maneuvering during Slow Flight

Practice this maneuver with a variety of flap configurations while climbing, descending, and turning. Enter the maneuver in level flight and smoothly reduce power. Maintain altitude while the aircraft slows to the desired airspeed and trim the aircraft. Add flaps as desired at  $V_{FE}$ . Add power as necessary to maintain the desired altitude. Maintain coordination throughout the maneuver with rudder control. Recover from this maneuver if a stall is encountered.

### Limitations

- Minimum recovery altitude: 1,500 feet AGL,
- Limited to VMC.

### Execution

- Execute clearing turns,
- Reduce power,
  - SR20 - 20% Power / 15" MP (approximately),
  - SR22 - 15% Power / 12" MP (approximately),
  - SR22TN - 25% Power / 12" MP (approximately),
  - SR22T - 30% Power / 12.5" MP (approximately).
- Flaps as desired (0% - 100%),
- Bank angle as desired (20° maximum),
- Airspeed - an airspeed at which any further increase in angle of attack, increase in load factor, or reduction in power would result in an immediate stall (current PTS standards),
- Power as required for level flight or desired climb or descent rate.

### Recovery

- Reduce angle of attack and level wings,
- Apply full power,
- Flaps 50%,
- Accelerate to  $V_Y$ ,
- Flaps 0%,
  - SR20 - 85 KIAS,



- SR22 - 80 KIAS.
- Clear of terrain and obstacles,
- Positive rate of climb.

## Completion Standards

- Exhibits knowledge of the elements related to this maneuver and complies with limitations, execution, and recovery procedures described in this manual,
- (Private) Maintains altitude +/-100 feet, airspeed +10/-0 KIAS, bank angle +/- 10 degrees, desired heading +/-10 degrees,
- (Commercial) Maintains altitude +/-50 feet, airspeed +5/-0 KIAS, bank angle +/-5 degrees, desired heading +/-10 degrees,
- Accomplishes coordinated straight-and-level flight, turns, climbs, and descents with flap configurations specified by the instructor,
- Divides attention between visual references and instrument scan.

## Common Errors

- Fails to maintain coordination during maneuver,
- Fails to recognize the signs of an impending stall,
- Fails to understand and apply proper power and pitch control inputs when changing or correcting airspeed and/or altitude deviations.

## Power-Off Stalls

Practice this maneuver with varying flap configurations. Enter this maneuver from a level attitude by reducing the power and adding flaps as desired at  $V_{FE}$ . At 80 KIAS establish a descent of approximately 500 FPM, straight or turning. Once a stabilized descent is established, reduce power to idle and gradually increase pitch to a normal touchdown attitude (7.5 degrees approximately). Adjust pitch to reduce airspeed approximately 1 KIAS / second. Recovery can be initiated at the incipient phase or full stall.

### Limitations

- Minimum recovery altitude: 1,500 feet AGL,
- Limited to VMC.

### Execution

- Execute clearing turns,
- Flaps as desired (0% - 100%),
- Establish glide or gliding turn slowing to 80 KIAS,
  - SR20 - 20% Power / 15" MP (approximately),
  - SR22 - 15% Power / 12" MP (approximately),
  - SR22TN - 25% Power / 12" MP (approximately),
  - SR22T - 30% Power / 12.5" MP (approximately).
- Descent rate 500 fpm (approximately),
- 20° max bank angle,
- Reduce throttle to idle and increase pitch to a normal landing attitude (5° to 7.5°) and induce a stall.

### Recovery

- Reduce angle of attack and level wings,
- Apply full power,
- Flaps 50%,
- Accelerate to  $V_Y$ ,
- Flaps 0%,
  - Airspeed 80 KIAS (SR22) 85 KIAS (SR20),
  - Clear of terrain and obstacles,

- Positive rate of climb.

## Completion Standards

- Exhibits knowledge of the elements related to this maneuver and complies with limitations, execution, and recovery procedures described in this manual,
- Describes factors that affect stall speed and situations where unintentional stalls are likely to occur,
- Transitions smoothly from the approach or landing attitude to a pitch attitude that will induce a stall,
- (Private) Maintains a specified heading +/-10 degrees in straight flight, maintains a specified angle of bank not to exceed 20 degrees, angle of bank +/-10 degrees in turning flight while inducing stall,
- (Commercial) Maintains a specified heading +/-10 degrees in straight flight, maintains a specified angle of bank not to exceed 20 degrees, angle of bank +/-5 degrees in turning flight while inducing stall,
- Recognizes and recovers promptly after the stall occurs by simultaneously reducing the angle of attack, increasing power to maximum allowable, and leveling the wings to return to a straight-and-level flight attitude with a minimum loss of altitude,
- Retracts flaps from 100% to 50% once the descent has been stopped and then retracts flaps from 50% to 0% once a positive rate of climb is established with airspeed at or above that recommended,
- Returns to the previous altitude, heading, and airspeed specified by the instructor.

## Common Errors

- Fails to add sufficient rudder input during stall recovery,
- Retracts flaps prematurely during recovery, resulting in excessive loss of altitude,
- Fails to promptly apply full power resulting in an excessive loss of altitude and/or delayed recovery,
- Increases pitch excessively, resulting in a secondary or unintentional stall.

## Power-On Stalls

Practice this maneuver with 0% and/or 50% flaps, straight and turning. Enter the maneuver from level flight by reducing power and adding flaps as desired at  $V_{FE}$ . Slow the aircraft to  $V_R$  while maintaining altitude. At  $V_R$  smoothly apply a minimum of 65% power and pitch the aircraft at an angle to induce a stall. Apply rudder to maintain coordination. Recover from this maneuver at the incipient phase or full stall.

### Limitations

- Minimum recovery altitude: 1,500 feet AGL,
- Limited to VMC,
- Limit nose high attitude to 30 degrees as per Private and Commercial Practical Test Standards,
- Minimum percent power is 65%

### Execution

- Execute clearing turns,
- Flaps 0% or 50% as desired,
- Airspeed- slow to  $V_R$ ,
  - SR20 - 20% Power / 15" MP (approximately),
  - SR22 - 15% Power / 12" MP (approximately),
  - SR22TN - 25% Power / 12" MP (approximately),
  - SR22T - 30% Power / 12.5" MP (approximately).
- Bank angle as desired (20 degrees maximum),
- Apply a minimum of 65% power,
- Increase pitch angle to induce stall (maximum 30-degree pitch attitude).

### Recovery

- Reduce angle of attack and level wings,
- Verify full power,
- Accelerate to  $V_Y$ ,
- Flaps 0%,

- Airspeed 80 KIAS (SR22) 85 KIAS (SR20),
- Clear of terrain and obstacles,
- Positive rate of climb.

## Completion Standards

- Exhibits knowledge of the elements related to this maneuver and complies with limitations, execution and recovery procedures described in this manual,
- (Private) Maintains a specified heading within +/-10 degrees in straight flight, and a specified angle of bank (less than 20 degrees) within +/-10 degrees,
- (Commercial) Maintains a specified heading within +/-5 degrees in straight flight, and a specified angle of bank (less than 20 degrees) within +/-10 degrees,
- Recognizes and recovers promptly after the stall occurs by simultaneously reducing the angle of attack, increasing power as appropriate, and leveling the wings to return to a straight-and-level flight attitude with a minimum loss of altitude,
- Retracts flaps from 50% to 0% when the aircraft has resumed a climb at or above the recommended flap retraction airspeed.

## Common Errors

- Fails to apply proper rudder inputs to maintain coordination during maneuver,
- Reduces pitch attitude too much during recovery, causing an excessive loss of altitude,
- Fails to maintain heading within standards through proper rudder and aileron inputs during maneuver, setup, and recovery.
- Exhibits a lack of knowledge of elements related to spins prevention and spin recovery.

## Autopilot Stall Recognition

The purpose of this maneuver is to identify the conditions when a stall with the autopilot engaged may occur, to recognize the effects of an impending autopilot stall, and to learn the recovery procedure. Do not exceed any autopilot limitations during this maneuver. The maneuver is started by programming the autopilot for conditions it is not capable of maintaining (excessive climb rate, insufficient power, etc). Autopilots with Perspective software load 764.09 or later have low-speed protection and respond differently than previous software loads. While software loads 764.08 and prior disconnect the autopilot below 80 KIAS, later loads will remain engaged and will switch mode priorities to maintain a flying airspeed above the stall speed.

Regardless of the software load, the highest priority is to regain aircraft control by decreasing the angle of attack and increasing airspeed. Reference the correct section below for maneuver setup and execution depending on the Perspective software load.

### Limitations

- Minimum recovery altitude: 1,500 feet AGL,
- Limited to VMC,
- All autopilot limitations in the AFM apply.

### Execution

- Execute clearing turns,
- Flaps as desired,
- Autopilot lateral and pitch modes as desired,
- Throttle insufficient for sustained flight.

### Recovery for Software Load 764.09 or later

- Smoothly apply full throttle, and
- Verify and maintain aircraft coordination,
- Reduce throttle as necessary once normal flight is resumed.

### Recovery for Software Load 764.08 or prior

- Disconnect autopilot and simultaneously:
  - Reduce angle of attack,
  - Increase throttle as required,

- Level wings,
- After initial recovery, return aircraft to previously assigned heading, altitude, or desired flight condition.

## **Completion Standards**

- Describes situations likely to lead to an autopilot stall or under-speed condition,
- Exhibits knowledge of the elements related to autopilot stalls and complies with limitations, execution and recovery procedures described in this manual,
- Recognizes and promptly corrects from an impending autopilot stall or slow flight condition,
- Minimizes loss of altitude by applying proper power inputs and controls aircraft pitch as necessary,
- Returns to previously assigned or desired flight parameters and advises ATC of any inability to maintain an ATC clearance.

## **Common Errors**

- Lacks knowledge of autopilot limitations,
- Becomes complacent and neglects to actively scan and monitor flight status during autopilot operations,
- Fails to verify active and armed autopilot modes,
- Fails to manage power required to maintain the desired airspeed and/or altitude.

## Ground Reference Maneuvers

Ground reference maneuvers described in this section are required by Private Pilot and Commercial Practical Test Standards. Practicing these maneuvers helps pilots develop fundamental skills of aircraft control, division of attention, and correction for wind drift. The skills developed while performing these maneuvers have real-life applicability and are the basis for many flight operations performed during normal day-to-day flight operations. Rated pilots should practice these maneuvers to hone skills during recurrent training events and flight reviews.

Complete ground reference maneuvers in an area with an available emergency landing spot. Do not practice ground reference maneuvers in a noise sensitive area. Be sure to avoid areas with towers or congested traffic.

The decision to deploy CAPS must be made immediately below 2,000 feet AGL. Pre-brief if CAPS will be a viable option to increase survival potential if a catastrophic engine failure is experienced during ground reference maneuvers.

It may be beneficial to inhibit TAWS during ground reference maneuvers to reduce cockpit distractions. Ensure the area is free of obstacle or terrain hazards before inhibiting TAWS. Remember to uninhibit TAWS at the maneuver completion.

### Limitations

- Limited to VMC,
- Minimum altitude 600 feet AGL,
- Within all other regulatory altitude restrictions,
- Within a position to make an emergency landing.



## Rectangular Course (Private)

Select a rectangular area approximately one mile in length by a minimum of 1/2 mile wide. Enter the maneuver 45 degrees to the downwind at 1,000 feet AGL. Fly a ground track which is equidistant from all sides of the rectangular area while accounting for wind drift and maintaining constant airspeed and altitude.

Practice this maneuver using an actual runway traffic pattern at an uncontrolled airport with no traffic conflicts when developing basic traffic pattern skills and wind drift correction skills.

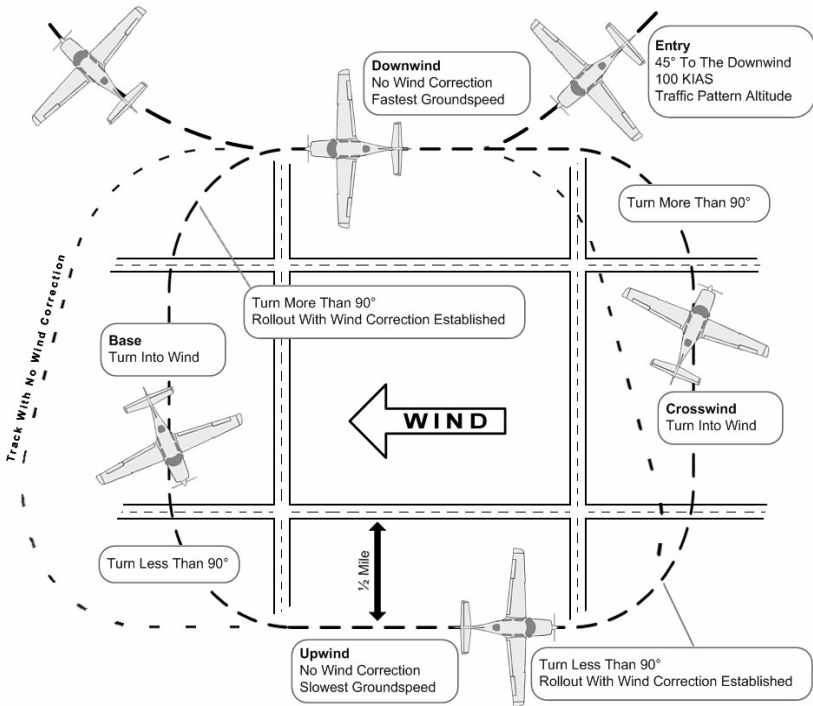

### Rectangular Course

#### Execution

- Execute clearing turns,
- Airspeed 100 KIAS,
  - SR20 - 50% Power / 20" MP (approximately),
  - SR22 - 30% Power / 15" MP (approximately),

- SR22TN - 50% Power / 15" MP (approximately),
- SR22T - 40% Power / 15" MP (approximately).
- Enter on the downwind leg at a 45-degree angle,
- Maintain approximately 1/2 mile from the reference line.

## Recovery

- Add power as necessary and climb to a desired altitude.

## Completion Standards

- Selects a suitable area to perform the maneuver considering emergency landing availability, noise abatement, and obstacle and terrain clearance,
- Applies adequate wind-drift correction during straight-and-turning flight to maintain a constant ground track around the rectangular reference area,
- Divides attention between aircraft control and ground track while maintaining coordinated flight,
- Maintains altitude, +/-100 feet, airspeed +/-10 KIAS.

## Common Errors

- Fails to apply proper rudder inputs to maintain coordinated flight during the maneuver,
- Fails to clear the area for traffic, terrain, or obstacle hazards,
- Over controls pitch and roll excessively and exceeds performance standards,
- Fails to plan and anticipate wind correction for future segments,
- Displays an inability to quickly scan airspeed and altitude instrumentation.

## S-Turns (Private)

Select a road or other prominent straight line on the ground that lies perpendicular to the wind. Enter the maneuver on downwind at 1,000 feet AGL. Complete a series of 180-degree turns of uniform radius in opposite directions, recrossing the reference line at a 90-degree angle just as each 180-degree turn is completed. Apply the necessary wind correction to maintain a constant radius turn on each side of the reference line while maintaining constant airspeed and altitude. Limit bank angles to 45 degrees during the maneuver.

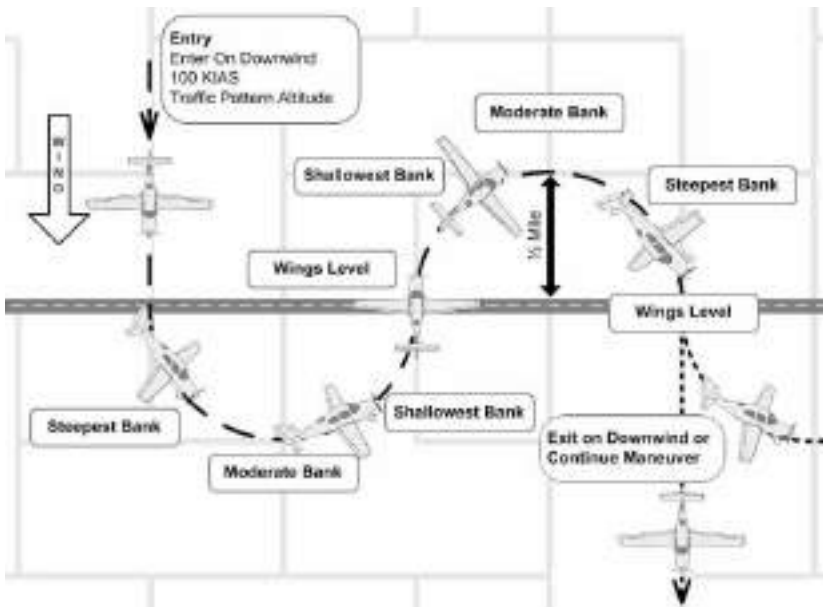

S-Turns

### Execution

- Execute clearing turns,
- Airspeed 100 KIAS,
  - SR20 - 50% Power / 20" MP (approximately),
  - SR22 - 30% Power / 15" MP (approximately),
  - SR22TN - 50% Power / 15" MP (approximately),
  - SR22T - 40% Power / 15" MP (approximately).
- Enter the maneuver with the direction of the wind,

- Maintain approximately 1/2 mile radius from the reference line.

## Recovery

- Add power as necessary and climb to a desired altitude.

## Completion Standards

- Selects a suitable ground reference line perpendicular to the wind,
- Applies adequate wind-drift correction to track a constant radius turn on each side of the selected reference line,
- Reverses the direction of turn directly over the selected reference line,
- Divides attention between airplane control and ground track while maintaining coordinated flight,
- Maintains altitude, +/-100 feet, airspeed +/-10 KIAS,
- Remains clear of all obstacles or terrain.

## Common Errors

- Fails to apply proper rudder inputs to maintain coordinated flight,
- Fails to clear area for traffic, terrain, or obstacle hazards,
- Over-controls pitch and roll excessively,
- Fails to plan and anticipate wind correction for future segments,
- Displays an inability to quickly scan airspeed and altitude instrumentation,
- Over-banks the aircraft and allows an excessive descent rate or sacrifices airspeed causing an accelerated stall condition.

## Turns Around a Point (Private)

Find an area which will allow for safe execution of this maneuver and an available emergency landing area. Select a suitable, prominent ground reference point. Enter the maneuver on downwind at 1,000 feet AGL. Fly two or more complete, uniform-radius circles around the reference point while compensating for wind drift and maintaining constant airspeed and altitude. Limit bank angles to 45 degrees.

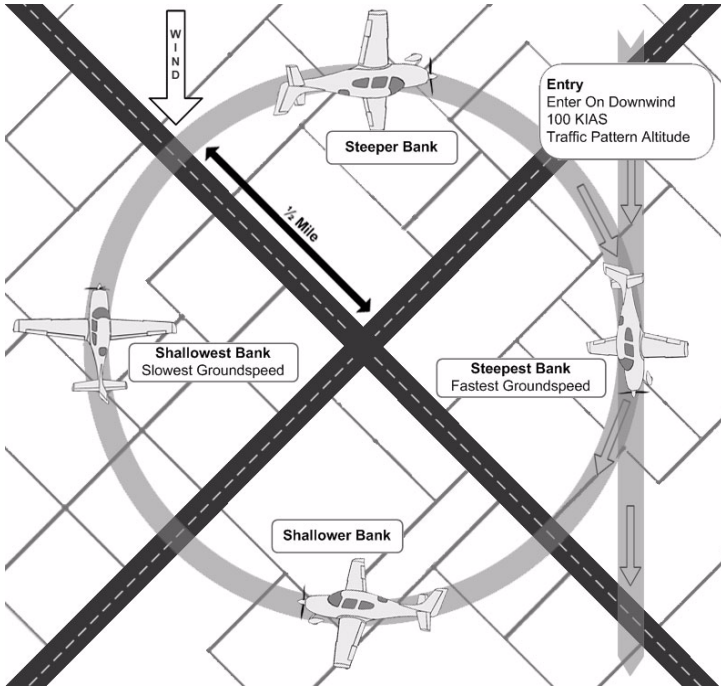

Turns Around a Point

### Execution

- Execute clearing turns,
- Airspeed 100 KIAS,
  - SR20 - 50% Power / 20" MP (approximately),
  - SR22 - 30% Power / 15" MP (approximately),
  - SR22TN - 50% Power / 15" MP (approximately),
  - SR22T - 40% Power / 15" MP (approximately).
- Enter with the wind and start a left or right turn,

- Maintain approximately 1/2 mile radius from reference point.

## Recovery

- Add power as required and climb to desired altitude.

## Completion Standards

- Selects a suitable ground reference point,
- Plans the maneuver so as to enter a left or a right turn at 1,000 feet AGL, at an appropriate distance from the reference point,
- Applies adequate wind-drift correction to track a constant radius turn around the selected reference point,
- Divides attention between airplane control and ground track while maintaining coordinated flight,
- Maintains altitude +/-100 feet, airspeed +/-10 KIAS.

## Common Errors

- Fails to apply proper rudder inputs to maintain coordination,
- Fails to anticipate wind conditions for future segments,
- Banks excessively on the upwind segment of the maneuver,
- Fails to adjust pitch control while changing angles of bank,
- Focuses excessively inside the aircraft,
- Fails to scan for traffic during maneuver.

## **Eight On Pylons (Commercial)**

Eights on pylons is the most advanced and most difficult of ground reference maneuvers. Because of the various techniques involved, eights on pylons is unsurpassed for teaching, developing, and testing subconscious control of the airplane.

This training maneuver involves flying the airplane in circular paths, alternately left and right, in the form of a figure "eight" around two selected points or pylons on the ground. Unlike eights around pylons, however, no attempt is made to maintain a uniform lateral distance from the pylon. In eights on pylons, the distance from the pylons varies if there is any wind. Instead, the airplane is flown at such a precise altitude and airspeed that a line parallel to the airplane's lateral axis, and extending from the pilot's eye, appears to pivot on each of the pylons.

Also, unlike eights around pylons, in the performance of eights on pylons the degree of bank increases as the distance from the pylon decreases. The altitude that is appropriate for the airplane being flown is called the pivotal altitude and is governed by the groundspeed. While not truly a ground track maneuver as were the preceding maneuvers, the objective is similar: to develop the ability to maneuver the airplane accurately while dividing one's attention between the flight path and the selected points on the ground. In explaining the performance of eights on pylons, the term "wing tip" is frequently considered as being synonymous with the proper reference line, or pivot point on the airplane. The selected pylons should also be at the same elevation, since differences of over a very few feet will necessitate climbing or descending between each turn.

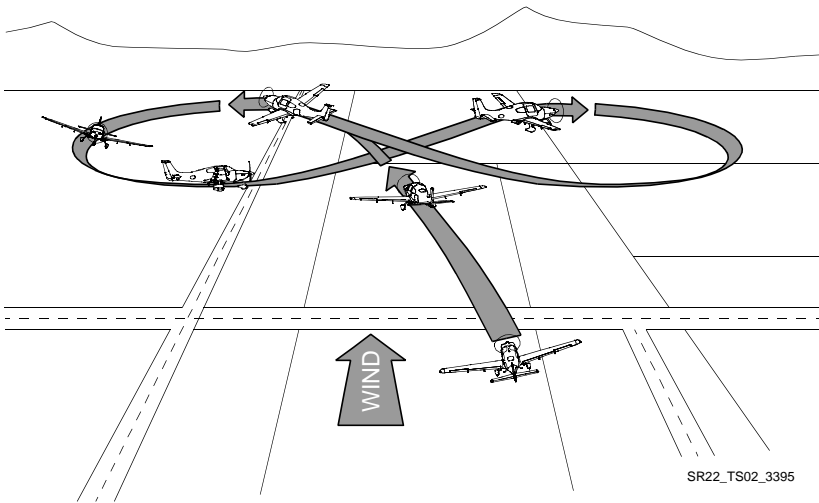

### Eight On Pylons

#### Execution

- Calculate approximate pivotal altitude ( $TAS^2$  squared and divided by 11.3),
- Define visible ground reference points separated by approximately 3/4 NM and perpendicular to the wind,
- Establish level flight at calculated pivotal altitude at 120 KIAS,
  - SR20 - 60% Power / 21" MP (approximately),
  - SR22 - 30% Power / 18" MP (approximately),
  - SR22TN - 55% Power / 20" MP (approximately),
  - SR22T - 50% Power / 18" MP (approximately).
- Cross diagonally between points with the wind so that the first turn is made into the wind,
- Adjust angle of bank as required to maintain a sight line with the reference point(s),
- Adjust pitch as required to maintain pivotal altitude, which changes with ground speed,
- Apply rudder as required to maintain coordination,



- Complete the desired number of figure “eight” circuits around the reference points.

## Recovery

- Add power as required and climb to desired altitude.

## Completion Standards

- Describes elements related to pivotal altitude,
- Determines the approximate pivotal altitude,
- Enters the maneuver at the appropriate altitude and airspeed and at a bank angle of approximately 30 to 40 degrees at the steepest point,
- Divides attention between accurate coordinated airplane control and outside visual references,
- Holds pylon using appropriate pivotal altitude avoiding slips and skids.

## Common Errors

- Exhibits inadequate knowledge relating to pivotal altitude, and/or ability to visualize maneuver,
- Makes a poor choice of ground reference points,
- Fails to consider surface winds, obstacles, emergency landing areas and/or traffic when defining ground reference points,
- Enters above or below calculated pivotal altitude,
- Uses rudder inputs to position the reference point on the pylon.

Intentionally Left Blank

# Section 6

## Performance

### General

To determine what performance to expect from the airplane under various ambient and field conditions, Refer to Section 5 - Performance, of the Pilot's Operating Handbook. Performance data are presented for takeoff, climb, and cruise (including range & endurance).

Intentionally Left Blank

# Section 7

## Limitations

### General

The Limitations Section of the Pilot's Operating Handbook (POH) is the official document approved by the Federal Aviation Administration. It provides operating limitations, instrument markings, basic placards required by regulation, and standard systems and equipment required for safe operation. For amended operating limitations for airplanes equipped with optional equipment, refer to Section 9 - Supplements of the Pilot's Operating Handbook.

Compliance with the operating limitations in Pilot's Operating Handbook is required by Federal Aviation Regulations.

Intentionally Left Blank