

Beechcraft®

Bonanza®

F33A

(Serials CE-290 thru CE-673)

F33C ACROBATIC

(Serials CJ-26 thru CJ-128)
(See Flight Manual Supplement)

Pilot's Operating Handbook and FAA Approved Airplane Flight Manual

FAA Approved in Utility Category based on CAR 3. This document must be carried in the airplane at all times and be kept within reach of the pilot during all flight operations.

This handbook includes the material required to be furnished to the pilot by CAR 3.

Airplane Serial Number:

CE-432

Airplane Registration Number:

N1074W

FAA Approved:

A. C. Jackson
A. C. Jackson
Beech Aircraft Corporation
DOA CE-2

This handbook supersedes all BEECH published owner's manuals, flight manuals, and check lists issued for this airplane with the exception of FAA Approved Airplane Flight Manual Supplements.

COPYRIGHT © BEECH 1986

P/N 33-590009-15
Issued: November, 1977

P/N 33-590009-15A5
Revised: January, 1986

BEECHCRAFT Bonanza F33A
CE-290 thru CE-673

Section I
General

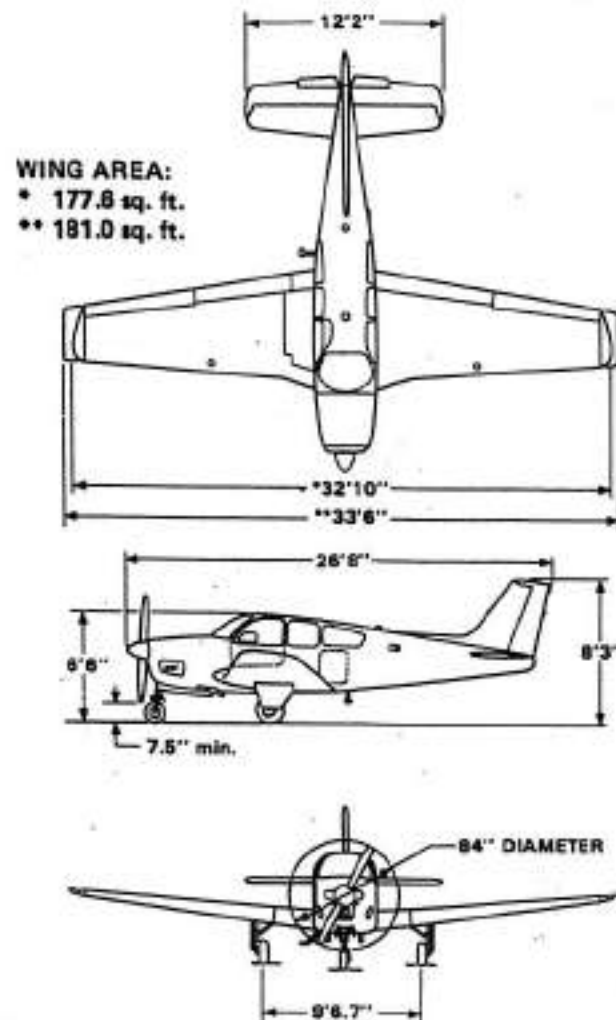

*F33A prior to CE-316 **F33A, CE-316 and after
AIRPLANE THREE-VIEW

Revised: March 1983

1-7

**BEECHCRAFT Bonanza F33A
CE-290 thru CE-673**

**Section I
General**

PROPELLER

McCaughey constant speed, two blade, 84 inch diameter propeller using a McCaughey 2A36C23 hub with 84B-0 blades.

or

McCaughey constant speed, three blade, 80 inch diameter propeller using a McCaughey 3A32C76 hub with 82NB-2 blades.

or

Hartzell constant speed, three blade, 82 inch diameter propeller using a Hartzell PHC-A3VF-4 hub with V8433-2R or V8433-4R blades.

NOTE

Other propellers are approved and are listed in the FAA Aircraft Specification 3A15 or are approved by Supplemental Type Certificate.

FUEL

Aviation Gasoline 100LL (blue) or 100 (green) minimum grade.

STANDARD SYSTEM

Total Capacity 50 gal.
Total Usable 44 gal.

OPTIONAL SYSTEM

Total Capacity 80 gal.
Total Usable 74 gal.

November 1977

1-9

3600 as per STC

Section I
General

BEECHCRAFT Bonanza F33A
CE-290 thru CE-673

OIL CAPACITY

The oil capacity is 12 quarts.

WEIGHTS

Maximum Ramp Weight 3412 lbs
Maximum Take-Off Weight 3400 lbs
Maximum Landing Weight 3400 lbs
Maximum Zero Fuel Weight No Structural Limit
Maximum Weight in
Baggage Compartment 270 lbs.

3600

CABIN AND ENTRY DIMENSIONS

Length (CE-290 thru CE-315) 8 ft 6 in.
Length (CE-316 thru CE-673) 10 ft 1 in.
Height 4 ft 2 in.
Width 3 ft 6 in.
Cabin Door 37 in. wide by 36 in. high

BAGGAGE SPACE AND ENTRY DIMENSIONS

Compartment Volume (Prior to CE-316) 16.5 cu ft
Hat Shelf Volume (Prior to CE-316) 5.9 cu ft
Compartment Volume (CE-316 and after) 35 cu ft
Hat Shelf Volume (CE-316 and after) 1.7 cu ft
Door Width (Minimum) 18.5 in.
Door Height (Minimum) 22.5 in.

SPECIFIC LOADINGS (Maximum Take-Off Weight)

Wing Loading (CE-290 thru CE-315) 19.1 lbs/sq ft
Wing Loading (CE-316 thru CE-673) 18.8 lbs/sq ft
Power Loading 11.9 lbs/hp

SECTION II

LIMITATIONS

TABLE OF CONTENTS

<i>SUBJECT</i>	<i>PAGE</i>
Airspeed Limitations	2-3
Airspeed Indicator Markings	2-4
Power Plant Limitations	2-5
Engine	2-5
Operating Limitations	2-5
Fuel Grades	2-5
Oil Specifications	2-5
Propeller Specifications	2-6
Power Plant Instrument Markings	
(Round Type)	2-7
Miscellaneous Instrument Markings	
(Round Type)	2-8
Power Plant Instrument Markings	
(Vertical Electrically Operated Type)	2-8
Miscellaneous Instrument Markings	
(Vertical Electrically Operated Type)	2-9
Weight Limits	2-9
Center of Gravity Limits (Gear Down)	2-10
Maneuver Limits	2-10
Approved Maneuvers	2-10
Flight Load Factors	2-10
Minimum Flight Crew	2-11
Kinds of Operation Limits	2-11
Required Equipment for Various	
Conditions of Flight	2-11

TABLE OF CONTENTS (Continued)

SUBJECT	PAGE
Fuel	2-21
Standard System	2-21
Optional System	2-21
Fuel Management	2-21
Seating	2-21
Placards	2-22

The limitations included in this section have been approved by the Federal Aviation Administration.

The following limitations must be observed in the operation of this airplane.

AIRSPPEED LIMITATIONS

SPEED	CAS		IAS		REMARKS
	KNOTS	MPH	KNOTS	MPH	
Never Exceed V_{NE}	195	225	196	226	Do not exceed this speed in any operation
Maximum Structural Cruising V_{NO} or V_C	165	190	167	192	Do not exceed this speed except in smooth air and then only with caution
Maneuvering V_A	132	152	134	154	Do not make full or abrupt control movements above this speed
Maximum Flap Extension Extended V_{FE}	122	140	123	142	Do not extend flaps or operate with flaps extended above this speed
Maximum Landing Gear Operating/ Extended V_{LO} and V_{LE}	152	175	154	177	Do not extend, retract or operate with landing gear extended above this speed except in emergency

Section II
Limitations

BEECHCRAFT Bonanza F33A
CE-290 thru CE-673

*AIRSPEED INDICATOR MARKINGS

MARKING	CAS		IAS		SIGNIFICANCE
	KNOTS	MPH	KNOTS	MPH	
White Arc	55-122	63-140	54-123	62-142	Full Flap Operating Range
Green Arc	63-165	73-190	63-167	73-192	Normal Operating Range
Yellow Arc	165-195	190-225	167-196	192-226	Operate with caution only in smooth air
Red Line	195	225	196	226	Maximum speed for ALL operations

*The Airspeed Indicator is marked in CAS values

BEECHCRAFT Bonanza F33A
CE-290 thru CE-673

Section II
Limitations

POWER PLANT LIMITATIONS

ENGINE

One Teledyne Continental Motors Corporation model IO-520-B, IO-520-BA or IO-520-BB engine

OPERATING LIMITATIONS

Engine Speed 2700 rpm
 Cylinder Head Temperature 460°F/238°C
 Oil Temperature 240°F/116°C
 Oil Pressure
 Minimum 30 psi
 Maximum 100 psi
 Fuel Pressure
 Minimum 1.5 psi
 Maximum 17.5 psi
 Mixture - Set per leaning instructions on performance charts.

FUEL GRADES

Aviation Gasoline 100LL (blue) or 100 (green) minimum grade.

OIL SPECIFICATIONS

Ashless dispersant oils must meet latest revision of Teledyne Continental Motors Corporation Specification MHS-24. Refer to Approved Engine Oils, Section VIII, HANDLING, SERVICING and MAINTENANCE.

Revised: March 1983

Section II
Limitations

BEECHCRAFT Bonanza F33A
CE-290 thru CE-673

PROPELLER SPECIFICATIONS

McCaughey constant speed, two blade propeller
Hub: 2A36C23
Blades: B4B-0
Diameter: Maximum 84 in., Minimum 82 in.
Pitch settings at 30 in. sta.:
Low - 13.3°
High - not under 29.2°

or

McCaughey constant speed, three bladed propeller
Hub: 3A32C76
Blades: 82NB-2
Diameter: Maximum 80 in., Minimum 78.5 in.
Pitch settings at 30 in. sta.:
Low - 13.3° ± 0.2°
High - not under 29.0° ± 0.5°

or

Hartzell constant speed, three blade propeller
Hub: Hartzell PHC-A3VF-4
Blades: VB433-2R or VB433-4R
Diameter: Maximum 82 in., Minimum 78-1/4 in.
Pitch settings at 30 in. sta.:
Low - 10.5° for VB433-2R
- 11.2° for VB433-4R
High - 30.8° for both

NOTE

Other propellers are approved and are listed in the FAA Aircraft Specification 3A15 or are approved by Supplemental Type Certificate.

BEECHCRAFT Bonanza F33A
CE-290 thru CE-673

Section II
Limitations

POWER PLANT INSTRUMENT MARKINGS
(ROUND TYPE)

OIL TEMPERATURE

Caution (Yellow Radial) 100°F/38°C
Operating Range
(Green Arc) 100° to 240°F/38° to 116°C
Maximum (Red Radial) 240°F/116°C

OIL PRESSURE

Minimum Pressure (Red Radial) 30 psi
Operating Range (Green Arc) 30 to 60 psi
Maximum Pressure (Red Radial) 100 psi

FUEL FLOW

Minimum (Red Radial) 1.5 psi
Operating Range (Green Arc) 6.9 to 24.3 gph
or 41.4 to 145.8 pph
Maximum (Red Radial) 17.5 psi

TACHOMETER

Operating Range (Green Arc) ... 1800 to 2700 rpm
Maximum RPM (Red Radial) 2700 rpm

CYLINDER HEAD TEMPERATURE

Operating Range
(Green Arc) 200° to 460°F/93° to 238°C
Maximum Temperature
(Red Radial) 460°F/238°C

MANIFOLD PRESSURE

Operating Range
(Green Arc) 15 to 29.6 in. Hg
Maximum (Red Radial) 29.6 in. Hg

Section II
Limitations

BEEHCRAFT Bonanza F33A
CE-290 thru CE-673

MISCELLANEOUS INSTRUMENT MARKINGS
(ROUND TYPE)

INSTRUMENT PRESSURE

Minimum (Red Radial)	3.5 in. Hg
Operating Range (Green Arc)	3.5 to 5.5 in. Hg
Maximum (Red Radial)	5.5 in. Hg
or	
Operating Range (Green Arc)	4.3 to 5.9 in. Hg

FUEL QUANTITY

Yellow Band (44-gallon system)	E to 1/2 full
Yellow Band (74-gallon system)	E to 3/8 full

POWER PLANT INSTRUMENT MARKINGS
(VERTICAL ELECTRICALLY OPERATED TYPE)

OIL TEMPERATURE

Caution (Yellow Line)	100°F/38°C
Operating Range (Green Band)	100° to 240°F/38° to 116°C
Maximum (Red Line)	240°F/116°C

OIL PRESSURE

Minimum Pressure (Red Line)	30 psi
Operating Range (Green Band)	30 to 60 psi
Maximum Pressure (Red Line)	100 psi

FUEL FLOW

Minimum (Red Line)	1.5 psi
Operating Range (Green Band) ..	41.4 to 145.8 pph
Maximum (Red Line)	17.5 psi

TACHOMETER

Operating Range (Green Band) ..	1800 to 2700 rpm
Maximum RPM (Red Line)	2700 rpm

BEEHCRAFT Bonanza F33A
CE-290 thru CE-673

Section II
Limitations

CYLINDER HEAD TEMPERATURE

Operating Range (Green Band)	200° to 460°F/93° to 238°C
Maximum Temperature (Red Line)	460°F/238°C

MANIFOLD PRESSURE

Operating Range (Green Band)	15 to 29.6 in. Hg
Maximum (Red Line)	29.6 in. Hg

MISCELLANEOUS INSTRUMENT MARKINGS
(VERTICAL ELECTRICALLY OPERATED TYPE)

INSTRUMENT PRESSURE

Minimum (Red Radial)	3.5 in. Hg
Operating Range (Green Arc)	3.5 to 5.5 in. Hg
Maximum (Red Radial)	5.5 in. Hg
or	
Operating Range (Green Arc)	4.3 to 5.9 in. Hg

FUEL QUANTITY

Yellow Band (22-gal Main Tank)	0 to 80 lbs.
Yellow Band (37-gal Main Tank)	0 to 80 lbs.

WEIGHT LIMITS

Maximum Ramp Weight	3412 lbs
Maximum Take-off and Landing Weight	3400 lbs
Zero Fuel Weight	No Structural Limitation
Maximum Baggage Compartment Load	270 lbs

Section II
Limitations

BEECHCRAFT Bonanza F33A
CE-290 thru CE-673

CENTER OF GRAVITY LIMITS (Gear Down)

Forward: 77.0 inches aft of datum to 2800 lbs with straight line variation to 82.1 inches at 3400 lbs.

Aft: 86.7 inches aft of datum at all weights.

REFERENCE DATUM

Datum is 83.1 inches forward of center line through forward jack points.

MAC leading edge is 66.7 inches aft of datum.
MAC length is 65.3 inches.

MANEUVER LIMITS

This is a utility category airplane. Spins are prohibited. No acrobatic maneuvers are approved except those listed below. Maximum slip duration is 30 seconds.

APPROVED MANEUVERS (3400 POUNDS)

MANEUVER	ENTRY SPEED (CAS)
Chandelle	132 kts/152 mph
Steep Turn	132 kts/152 mph
Lazy Eight	132 kts/152 mph
Stall (Except Whip)	Use slow deceleration

Minimum fuel for above maneuvers - 10 gallons each main tank.

Spins are prohibited.

FLIGHT LOAD FACTORS (3400 POUNDS)

Positive Maneuvering Load Factors

Flaps Up	4.4G
Flaps Down	2.0G

2-10

Revised: March 1983

BEECHCRAFT Bonanza F33A
CE-290 thru CE-673

Section II
Limitations

MINIMUM FLIGHT CREW

One (1) Pilot

KINDS OF OPERATION LIMITS

1. VFR day and night
2. IFR day and night

REQUIRED EQUIPMENT FOR VARIOUS CONDITIONS OF FLIGHT

Federal Aviation Regulations (91.3(a), 91.24, 91.25, 91.32, 91.33, 91.52, 91.90, 91.97, 91.170) specify the minimum numbers and types of airplane instruments and equipment which must be installed and operable for various kinds of flight conditions. This includes VFR day, VFR night, IFR day, and IFR night.

Regulations also require that all airplanes be certificated by the manufacturer for operations under various flight conditions. At certification, all required equipment must be in operating condition and should be maintained to assure continued airworthiness. If deviations from the installed equipment were not permitted, or if the operating rules did not provide for various flight conditions, the airplane could not be flown unless all equipment was operable. With appropriate limitations, the operation of every system or component installed in the airplane is not necessary, when the remaining operative instruments and equipment provide for continued safe operation. Operation in accordance with limitations established to maintain airworthiness, can permit continued or uninterrupted operation of the airplane temporarily.

For the sake of brevity, the Required Equipment Listing does not include obviously required items such as wings,

November 1977

2-11

**BEECHCRAFT Bonanza F33A
CE-290 thru CE-673**

**Section II
Limitations**

FUEL

STANDARD SYSTEM

Total Capacity 50 gal.
Total Usable 44 gal.

OPTIONAL SYSTEM

Total Capacity 80 gal.
Total Usable 74 gal.

FUEL MANAGEMENT

Take off on main tank that is more nearly full.

When operating fuel selector, feel for detent position.

Do not take off when Fuel Quantity Gages indicate in Yellow Band or with less than 13 gallons in each main tank.

Maximum slip duration: 30 seconds

SEATING

All seats must be in the upright position for take-off and landing.

**BEECHCRAFT Bonanza F33A
CE-290 thru CE-673**

**Section II
Limitations**

On Left Side Panel (Airspeed values are CAS):

(CE-290 thru CE-408)

UTILITY CATEGORY AIRPLANE	
THIS AIRPLANE MUST BE OPERATED IN COMPLIANCE WITH THE OPERATING LIMITATIONS STATED IN THE FORM OF PLACARDS, MARKINGS AND MANUALS. MAXIMUM WEIGHT 3400 LB. REFER TO WEIGHT AND BALANCE DATA FOR LOADING INSTRUCTIONS. OCCUPIED SEATS MUST BE IN UPRIGHT POSITION DURING TAKEOFF AND LANDING. ALTITUDE LOST IN STALL RECOVERY 300 FEET. FLIGHT MANEUVER LOAD FACTOR: FLAPS UP 4.4 G; FLAPS DOWN 2.0 G NO AEROBATIC MANEUVERS APPROVED EXCEPT THOSE LISTED BELOW:	
MANEUVER	MAXIMUM ENTRY SPEED
CHANDELLES	162 MPH (132 KNOTS)
LAZY EIGHTS	162 MPH (132 KNOTS)
STEEP TURNS	162 MPH (132 KNOTS)
STALLS (EXCEPT WHIP STALLS)	SLOW DECELERATION
NOTE: INTENTIONAL SPINS PROHIBITED	
AIRSPEED LIMITATION	
MAXIMUM LANDING GEAR EXTENDED SPEED	176 MPH (162 KNOTS)
MAXIMUM DESIGN MANEUVER SPEED	162 MPH (132 KNOTS)

Section II
Limitations

BEECHCRAFT Bonanza F33A
CE-290 thru CE-673

PLACARDS (Cont'd)

On Left Side Panel (Airspeed values are CAS):
(CE-409 thru CE-673)



On Left Side of Control Console Support:



On Left Side Panel Near Firewall Air Controls:

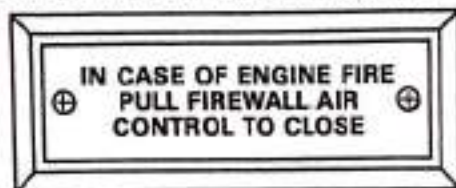

Section II
Limitations

BEECHCRAFT Bonanza F33A
CE-290 thru CE-673

PLACARDS

On Fuel Selector Valve:

Standard 44 Gallon (Usable) System:

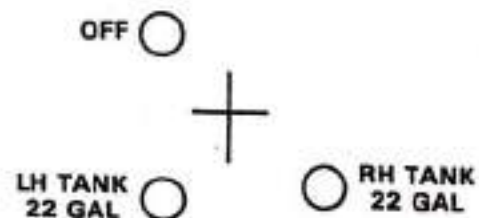

Optional 74 Gallon (Usable) Fuel System:

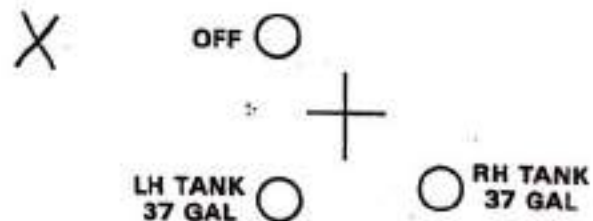

On Fuel Selector Panel:



**BEECHCRAFT Bonanza F33A
CE-290 thru CE-673**

**Section II
Limitations**

*On Inboard Side of Seat
Back for 3rd & 4th Seats:
(CE-634 thru CE-673)*



*Below Left and Right Middle Windows after compliance
with BEECHCRAFT Service Instructions 1241:*

**EMERGENCY EXIT
LIFT LATCH - PULL PIN
PUSH WINDOW OUT**

On Middle Windows (Openable):

**DO NOT OPEN
IN FLIGHT**

**LATCH WINDOW
BEFORE TAKE-OFF**

*On Baggage Door when Side Facing Seat Installed:
(CE-290 thru CE-315)*

**NO SMOKING IN FIFTH SEAT
MAXIMUM FIFTH SEAT
STRUCTURAL CAPACITY - 170 POUNDS**

Revised: March 1983

2-29

**BEECHCRAFT Bonanza F33A
CE-290 thru CE-673**

**Section II
Limitations**

*In Full View Of The Pilot:
(Unless baffled main fuel cells are installed in both wings)*

**TURNING TYPE TAKEOFFS, AND
TAKEOFF IMMEDIATELY FOLLOWING
FAST TAXI TURN PROHIBITED. AVOID
PROLONGED SLIPS (20 SECONDS OR
MORE) WITH FUEL TANKS LESS THAN
HALF FULL.**

Revised: March 1979

2-31

SECTION III

EMERGENCY PROCEDURES

TABLE OF CONTENTS

SUBJECT	PAGE
Emergency Airspeeds	3-3
Engine Failure	3-4
During Take-Off Ground Roll	3-4
After Liftoff and in Flight	3-4
Engine Discrepancy Checks	3-5
Rough Running Engine	3-5
Loss of Engine Power	3-5
Air Start Procedure	3-5
Engine Fire	3-6
In Flight	3-6
On The Ground	3-6
Maximum Glide Configuration	3-6
Emergency Descent	3-7
Landing Emergencies	3-7
Landing Without Power	3-7
Landing Gear Retracted - With Power	3-7
Systems Emergencies	3-8
Propeller Overspeed	3-8
Alternator-Out Procedure	3-8
Alternator Overvoltage	3-8
Engine Instrument Malfunction	3-9
Unscheduled Electric Elevator Trim	3-9
Landing Gear Manual Extension	3-10
Landing Gear Retraction After Practice Manual Extension	3-11

EMERGENCY AIRSPEEDS

Emergency Descent	154 kts/177 mph
Glide	105 kts/121 mph
Emergency Landing Approach	83 kts/96 mph

CAUTION

The approach airspeed is higher than normal to assure the availability of control during flare without power.

All airspeeds quoted in this section are indicated airspeeds (IAS).

The following information is presented to enable the pilot to form, in advance, a definite plan of action for coping with the most probable emergency situations which could occur in the operation of the airplane. Where practicable, the emergencies requiring immediate corrective action are treated in check list form for easy reference and familiarization. Other situations, in which more time is usually permitted to decide on and execute a plan of action, are discussed at some length.

ENGINE FAILURE

DURING TAKE-OFF GROUND ROLL

1. Throttle - CLOSED
2. Braking - MAXIMUM
3. Fuel Selector Valve - OFF
4. Battery and Alternator Switches - OFF

AFTER LIFTOFF AND IN FLIGHT

Landing straight ahead is usually advisable. If sufficient altitude is available for maneuvering, accomplish the following:

1. Fuel Selector Valve - SELECT OTHER TANK (Check to feel detent)
2. Auxiliary Fuel Pump - ON
3. Mixture - FULL RICH, then LEAN as required
4. Magnetos - CHECK LEFT and RIGHT, then BOTH

NOTE

The most probable cause of engine failure would be loss of fuel flow or improper functioning of the ignition system.

If No Restart

1. Select most favorable landing site.
2. See EMERGENCY LANDING procedure.
3. The use of landing gear is dependent on the terrain where landing must be made.

ENGINE DISCREPANCY CHECKS

CONDITION: ROUGH RUNNING ENGINE

1. Mixture - FULL RICH, then LEAN as required
2. Magneto/Start Switch - CHECK LEFT and RIGHT, then BOTH

CONDITION: LOSS OF ENGINE POWER

1. Fuel Flow Gage - CHECK

If fuel flow is abnormally low:

- a. Mixture - FULL RICH
- b. Auxiliary Fuel Pump - ON (Lean as required)
- c. Auxiliary Fuel Pump - OFF if performance does not improve in a few moments

2. Fuel Quantity Indicator - CHECK for fuel supply in tank being used

If tank being used is empty:

Fuel Tank Selector Valve - SELECT OTHER FUEL TANK (feel for detent)

AIR START PROCEDURE

1. Fuel Selector Valve - SELECT TANK MORE NEARLY FULL (check to feel detent)
2. Throttle - RETARD
3. Mixture - FULL RICH
4. Auxiliary Fuel Pump - ON until power is regained, then OFF. (Leave on if engine driven fuel pump is inoperative.)
5. Throttle - ADVANCE to desired power
6. Mixture - LEAN as required

ENGINE FIRE

IN FLIGHT

The red FIREWALL AIR control on the outboard side of the left subpanel is used to close off all heating system outlets so that smoke and fumes will not enter the cabin. In the event of engine fire, shut down the engine as follows and make a landing:

1. Firewall Air Control - PULL TO CLOSE
2. Mixture - IDLE CUT-OFF
3. Fuel Selector Valve - OFF
4. Battery and Alternator Switches - OFF (Extending the landing gear can be accomplished manually if desired.)
5. Do not attempt to restart engine.

ON THE GROUND

1. Mixture - IDLE CUT-OFF
2. Fuel Selector Valve - OFF
3. Battery, Alternator and Magneto/Start Switches - OFF
4. Extinguish with Fire Extinguisher.

MAXIMUM GLIDE CONFIGURATION

1. Landing Gear - UP
2. Flaps - UP
3. Cowl Flaps - CLOSED
4. Propeller - PULL for LOW RPM
5. Airspeed - 105 kts/121 mph

Glide distance is approximately 1.7 nautical miles (2 statute miles) per 1000 feet of altitude above the terrain.

EMERGENCY DESCENT

1. Power - IDLE
2. Propeller - HIGH RPM
3. Landing Gear - DOWN
4. Airspeed - ESTABLISH 154 kts/177 mph

LANDING EMERGENCIES

LANDING WITHOUT POWER

The approach speed is higher than normal to assure the availability of control during flare without power. When assured of reaching the landing site selected, and on final approach:

1. Airspeed - 83 kts/96 mph
2. Fuel Selector Valve - OFF
3. Mixture - IDLE CUT-OFF
4. Magneto/Start Switch - OFF
5. Flaps - AS REQUIRED
6. Landing Gear - DOWN OR UP, DEPENDING ON TERRAIN
7. Battery and Alternator Switches - OFF

LANDING GEAR RETRACTED - WITH POWER

If possible, choose firm sod or foamed runway. Make a normal approach, using flaps as necessary. When you are sure of making the selected landing spot:

1. Throttle - CLOSED
2. Mixture - IDLE CUT-OFF
3. Battery and Alternator Switches - OFF
4. Fuel Selector Valve - OFF
5. Keep wings level during touchdown.
6. Get clear of the airplane as soon as possible after it stops.

SYSTEMS EMERGENCIES

PROPELLER OVERSPEED

1. Throttle - RETARD TO RPM RED LINE
2. Airspeed - REDUCE
3. Oil Pressure - CHECK

WARNING

If loss of oil pressure was the cause of overspeed, the engine will seize after a short period of operation.

4. Land - SELECT NEAREST SUITABLE SITE and follow LANDING EMERGENCIES procedure.

ALTERNATOR OUT PROCEDURE

An inoperative alternator will place the entire electrical operation of the airplane on the battery. Alternator malfunction will be indicated by the illumination of the alternator warning light, located on the instrument panel below the flight instruments. When this condition occurs in flight, all non-essential electrical loads should be discontinued to conserve the battery.

ALTERNATOR OVERVOLTAGE

If an alternator overvoltage condition occurs in flight:

1. Battery Switch and Alternator Switch - OFF MOMENTARILY, THEN ON (this resets overvoltage relay)

If overvoltage condition does not recur, continue to use the alternator.

If overvoltage condition persists:

2. Alternator Switch - OFF
3. Nonessential Electrical Equipment - OFF to conserve battery power.

ENGINE INSTRUMENT MALFUNCTION

In event of engine instrument malfunction, maintain the last known rpm and manifold pressure setting and proceed to the nearest suitable airfield and land. If a higher power setting is required, select maximum rpm and enrichen mixture appropriately.

CAUTION

At high altitudes and low power settings, full rich mixtures may result in poor engine operation. Adjust the mixture for smooth engine operation upon power reduction.

UNSCHEDULED ELECTRIC ELEVATOR TRIM

1. Airplane Attitude - MAINTAIN using elevator control.
2. Elevator Trim Thumb Switch (On Control Wheel) - MOVE IN DIRECTION OPPOSITE UNSCHEDULED PITCH TRIM to open circuit breaker.
3. Elevator Trim ON-OFF Switch (On Instrument Panel) - OFF
4. Manual Elevator Trim Control Wheel - RETRIM AS DESIRED.

NOTE

Do not attempt to operate the electric trim system until the cause of the malfunction has been determined and corrected.

LANDING GEAR MANUAL EXTENSION

Manual extension of the landing gear can be facilitated by first reducing airspeed. Then proceed as follows:

1. LDG GEAR Circuit Breaker (Right Subpanel) - OFF (PULL OUT)
2. Landing Gear Switch Handle - DOWN position
3. Handcrank Handle Cover (at rear of front seats) - REMOVE
4. Handcrank - ENGAGE and TURN COUNTERCLOCKWISE AS FAR AS POSSIBLE (approximately 50 turns)

CAUTION

The manual extension system is designed to lower the landing gear only. DO NOT ATTEMPT TO RETRACT THE GEAR MANUALLY.

5. If electrical system is operative, check landing gear position lights and warning horn (check LDG GR RELAY circuit breaker engaged).
6. Handcrank - DISENGAGE. Always keep it stowed when not in use.

WARNING

Do not operate the landing gear electrically with the handcrank engaged, as damage to the mechanism could occur. After emergency landing gear extension, do not move any landing gear controls or reset any switches or circuit breakers until airplane is on jacks as failure may have been in the gear up circuit and gear might retract on the ground.

LANDING GEAR RETRACTION AFTER PRACTICE MANUAL EXTENSION

After practice manual extension of the landing gear, the gear may be retracted electrically, as follows:

1. Handcrank - CHECK, STOWED
2. Landing Gear Motor Circuit Breaker - IN
3. Landing Gear - RETRACT

INDUCTION SYSTEM BLOCKAGE

An alternate induction air door, spring-loaded to the closed position, is located downstream from the induction air filter. If the induction air filter becomes blocked (e.g., ice, etc.), the differential air pressure normally opens the alternate induction air door to provide induction air from the bottom of the engine compartment. If the alternate induction air door becomes stuck in the closed position, it can be opened by pulling and releasing the T-handle located directly below the propeller control knob. This T-handle is placarded ALTERNATE AIR PULL AND RELEASE.

EMERGENCY STATIC AIR SOURCE SYSTEM

THE EMERGENCY STATIC AIR SOURCE SHOULD BE USED FOR CONDITIONS WHERE THE NORMAL STATIC SOURCE HAS BEEN OBSTRUCTED. When the airplane has been exposed to moisture and/or icing conditions (especially on the ground), the possibility of obstructed static ports should be considered. Partial obstructions will result in the rate of climb indication being sluggish during a climb or descent. Verification of suspected obstruction is possible by switching to the emergency system and noting a sudden sustained change in rate of climb. This may be accompanied by abnormal indicated airspeed and altitude changes beyond normal calibration differences.

Whenever any obstruction exists in the Normal Static Air System or the Emergency Static Air System is desired for use:

1. Pilot's Emergency Static Air Source - Switch to ON EMERGENCY.
2. For Airspeed Calibration and Altimeter Correction, refer to PERFORMANCE section.

CAUTION

Be certain the emergency static air valve is in the NORMAL position when system is not needed.

EMERGENCY EXITS

Emergency exits, provided by the openable window on each side of the cabin, may be used for egress in addition to the cabin door and the optional cargo door. An emergency exit placard is installed below the left and right middle windows.

To open each emergency exit:

1. Lift the latch.
2. Pull out the emergency release pin and push the window out.

NOTE

On CE-634 thru CE-673, for access past the 3rd and/or 4th seats, rotate the red handle, located on the lower inboard side of the seat back, and fold the seat back over.

UNLATCHED DOOR IN FLIGHT

If the cabin door is not locked it may come unlatched in flight. This may occur during or just after take-off. The door will trail in a position approximately 3 inches open, but the flight characteristics of the airplane will not be affected, except that rate of climb will be reduced. Return to the field in a normal manner. If practicable, during the landing flare-out have a passenger hold the door to prevent it from swinging open.

SPINS

Spins are prohibited. If a spin is entered inadvertently:

Immediately move the control column full forward and simultaneously apply full rudder opposite to the direction of the spin; continue to hold this control position until rotation stops and then neutralize all controls and execute a smooth pullout. Ailerons should be neutral and throttle in idle position at all times during recovery.

EMERGENCY SPEED REDUCTION

In an emergency, the landing gear may be used to create additional drag. Should disorientation occur under instrument conditions, the lowering of the landing gear will reduce the tendency for excessive speed build-up. This procedure would also be appropriate for a non-instrument rated pilot who unavoidably encounters instrument conditions or in other emergencies such as severe turbulence.

Should the landing gear be used at speeds higher than the maximum extension speed, a special inspection of the gear doors in accordance with shop manual procedures is required, with repair as necessary.

SECTION IV NORMAL PROCEDURES

TABLE OF CONTENTS

SUBJECT	PAGE
Airspeeds for Safe Operation	4-3
Preflight Inspection	4-4
Before Starting	4-7
External Power	4-7
Starting Engine Using Auxiliary Power Unit	4-8
Starting	4-8
After Starting and Taxi	4-10
Before Take-Off	4-10
Take-Off	4-11
Climb	4-11
Cruise	4-11
Leaning Using the Exhaust Gas Temperature Indicator (EGT)	4-12
Descent	4-13
Before Landing	4-13
Balked Landing	4-13
After Landing	4-14
Shutdown	4-14
Environmental Systems	4-14
Oxygen System	4-14
Preflight	4-14
Oxygen Duration	4-15
In Flight	4-16
After Using	4-16
Heating and Ventilation	4-17
Revised: March 1983	4-1

All airspeeds quoted in this section are indicated airspeeds (IAS)

AIRSPEDS FOR SAFE OPERATION

Take-off	
Lift-off	71 kts/82 mph
50 Ft.	77 kts/89 mph
Maximum Climb	
Best Rate (V_y)	96 kts/110 mph
Best Angle (V_x)	77 kts/89 mph
Cruise Climb	107 kts/123 mph
Maximum Turbulent Air Penetration	134 kts/154 mph
Balked Landing	70 kts/81 mph
Landing Approach	70 kts/81 mph
Maximum Demonstrated Crosswind	17 kts/20 mph

Section IV
Normal Procedures

BEECHCRAFT Bonanza F33A
CE-290 thru CE-673

PREFLIGHT INSPECTION

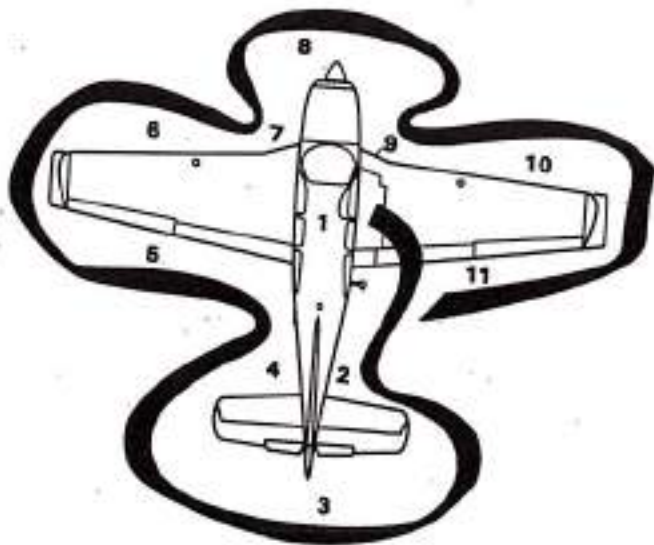

Emergency Locator Transmitter - ARMED
Location may vary with individual airplanes

1. CABIN:
 - a. Parking Brake - SET
 - b. Control Lock - REMOVE
 - c. All Switches - OFF
2. RIGHT FUSELAGE:
 - a. Baggage Compartment Door - SECURE
 - b. Static Pressure Button - UNOBSTRUCTED

4-4

November 1977

BEECHCRAFT Bonanza F33A
CE-290 thru CE-673

Section IV
Normal Procedures

3. EMPENNAGE:
 - a. Control Surfaces - CHECK
 - b. Tie Down - REMOVE
 - c. Position Light - CHECK
 - d. Cabin Air Intake - CHECK

4. LEFT FUSELAGE:
 - a. Static Pressure Button - UNOBSTRUCTED
 - b. All Antennas - CHECK

5. LEFT WING TRAILING EDGE:
 - a. Flap - CHECK
 - b. Aileron - CHECK
 - c. Wing Tip - CHECK
 - d. Position Light - CHECK

6. LEFT WING LEADING EDGE:
 - a. Stall Warning - CHECK
 - b. Pitot Tube - CHECK (Remove Cover)
 - c. Fuel Tank - CHECK QUANTITY; Filler Cap - SECURE.
 - d. Cabin Air Intake - CHECK
 - e. Tie Down and Chocks - REMOVE

7. LEFT LANDING GEAR:
 - a. Wheel Well Door, Tire and Strut - CHECK
 - b. Fuel Vent - CHECK
 - c. Fuel Sump - DRAIN
 - d. Fuel Selector Valve Sump - DRAIN; Cover - SECURE

November 1977

4-5

Section IV
Normal Procedures

BEEHCRAFT Bonanza F33A
CE-290 thru CE-673

8. NOSE SECTION:

- a. Left Cowl Flap - CHECK
- b. Engine Oil - CHECK (see Servicing, Section 8), Cap and Dipstick - SECURE
- c. Left Cowl - SECURE
- d. Propeller - CHECK, General Condition, Nicks, etc.
- e. Wheel Well Doors, Tire and Strut - CHECK
- f. Induction Air Intake - CLEAR
- g. Landing Lights - CHECK
- h. Engine - CHECK GENERAL CONDITION
- i. Right Cowl - SECURE
- j. Right Cowl Flap - CHECK
- k. Chocks - REMOVE

9. RIGHT LANDING GEAR:

- a. Fuel Vent - CHECK
- b. Fuel Sump - DRAIN
- c. Wheel Well Door, Tire and Strut - CHECK

10. RIGHT WING LEADING EDGE:

- a. Cabin Air Intake - CHECK
- b. Tie Down and Chocks - REMOVE
- c. Fuel Tank - CHECK QUANTITY; Filler Cap - SECURE

11. RIGHT WING TRAILING EDGE:

- a. Position Light - CHECK
- b. Wing Tip - CHECK
- c. Aileron - CHECK
- d. Flap - CHECK

CAUTION

NEVER TAXI IF ANY STRUT IS FLAT.

BEEHCRAFT Bonanza F33A
CE-290 thru CE-673

Section IV
Normal Procedures

BEFORE STARTING

1. Seats - POSITION AND LOCK; Seat Backs - UPRIGHT
2. Seat Belts and Shoulder Harnesses - FASTEN
3. Parking Brake - SET
4. All Avionics - OFF
5. Circuit Breakers - IN
6. Landing Gear Handle - DOWN; Safety System - CHECK (If installed)
7. Flaps - UP
8. Cowl Flaps - OPEN
9. Light Switches - As Required
10. Electric Elevator Trim Switch - OFF (If installed)
11. Fuel Selector Valve - CHECK OPERATION; SELECT TANK MORE NEARLY FULL
12. Battery and Alternator Switches - ON (If external power is used, turn Alternator Switch - OFF)
13. Fuel Quantity Indicators - CHECK QUANTITY

WARNING

Do not take off if gages indicate in yellow arc or with less than 13 gallons in each tank.

EXTERNAL POWER

When using external power, it is very important that the following precautions be observed:

1. The airplane has a negative ground system. Exercise care to avoid reversed polarity. Be sure to connect the positive lead of the external power unit to the positive terminal of the airplane's external power receptacle and the negative lead to the negative terminal of the external power receptacle. A positive voltage must also be applied to the small guide pin.

Section IV
Normal Procedures

BEECHCRAFT Bonanza F33A
CE-290 thru CE-673

2. To prevent arcing, make certain no power is being supplied when the connection is made.
3. Make certain that the battery switch is ON, all avionics and electrical switches OFF, and a battery is in the system before connecting an external power unit. This protects the voltage regulators and associated electrical equipment from voltage transients (power fluctuations).

STARTING ENGINE USING AUXILIARY POWER UNIT

1. Alternator, Electrical, and Avionics Equipment - OFF
2. Auxiliary Power Unit - CONNECT
3. Auxiliary Power Unit - SET OUTPUT (13.5 to 14.25 volts)
4. Auxiliary Power Unit - ON
5. Engine - START using normal procedures
6. Auxiliary Power Unit - OFF (after engine has been started)
7. Auxiliary Power Unit - DISCONNECT
8. Alternator Switch - ON

STARTING

CAUTION

Vernier-type engine controls should not be rotated clockwise after being advanced to the full forward position.

1. Mixture - FULL RICH
2. Propeller - HIGH RPM
3. Throttle - FULL OPEN
4. Auxiliary Fuel Pump - On until fuel flow peaks then OFF

4-8

16
November 1977

BEECHCRAFT Bonanza F33A
CE-290 thru CE-673

Section IV
Normal Procedures

5. Throttle - Approximately 1/4 inch open. *3 (1/4) Turns*
6. Magneto/Start Switch - START position; release to BOTH position when engine fires

CAUTION

Do not engage starter for more than 30 seconds in any 4-minute time period.

7. In Event of Overprime Condition:
 - a. Mixture - IDLE CUT-OFF
 - b. Throttle - OPEN
 - c. Magneto/Start Switch - START position
 - d. As engine fires, reduce throttle to IDLE and advance the mixture control to FULL RICH

NOTE

During hot starts, the Auxiliary Fuel Pump is turned on momentarily after starting to purge system, then turned off.

8. Throttle - 1000 to 1200 RPM
 9. Oil Pressure - CHECK
 10. External Power (if used) - DISCONNECT
 11. Alternator Switch - ON; CHECK FOR CHARGING
 12. All Engine Indicators - CHECK
 13. Avionics Meters - ON
- CAUTION

The ammeter indication should be less than 25% of full charge at 1000 to 1200 rpm within two minutes, with no additional electrical equipment on. If not, turn off the battery and generator switches and do not take off.

Revised: March 1983

4-9

AFTER STARTING, AND TAXI

1. Brakes - RELEASE AND CHECK
2. Avionics Equipment - ON, AS REQUIRED
3. Lights - AS REQUIRED

CAUTION

Do not operate engine above 1200 RPM until oil temperature reaches 75°F (24°C).

BEFORE TAKEOFF

1. Parking Brake - SET
2. Seat Belts and Shoulder Harnesses - CHECK

NOTE

All reclining seats must be in the upright position during takeoff.

3. Avionics - CHECK
4. Engine Instruments - CHECK
5. Flight Instruments - CHECK AND SET

NOTE

To ensure adequate gyro pressure when operating two air-driven gyros during ground operation and/or holding prior to takeoff, maintain an engine speed of 700-800 rpm in order to keep needle in the green arc on the instrument pressure gage. With a requirement of three or more air-driven gyros, maintain an engine speed of 1200 rpm.

6. Ammeter - CHECK - for stabilized indication between 0 and 25% of full charge at 1000 to 1200 rpm.
7. Auxiliary Fuel Pump - CHECK OFF
8. Throttle - 1700 RPM
9. Propeller - EXERCISE to obtain approximately 300 to 400 rpm drop; return to high rpm
10. Magnetos - CHECK at 1700 rpm (variance between individual magnetos should not exceed 50 rpm, maximum drop not to exceed 150 rpm.)
11. Trim - SET
 - a. Aileron - NEUTRAL (if installed)
 - b. Elevator - 0° (3° nose up if only front seats are occupied) 6°
12. Flaps - Check operation, then UP
13. Door and Windows - SECURE
14. Flight Controls - CHECK PROPER DIRECTION, FULL TRAVEL AND FREEDOM OF MOVEMENT
15. Mixture - FULL RICH (or as required by field elevation)
16. Brakes - RELEASED
17. Instruments - CHECK (Make final check of manifold pressure, fuel flow, and rpm at the start of the take-off run.)

INTENTIONALLY LEFT BLANK

TAKE-OFF

Take-Off Power Full Throttle, 2700 rpm

1. Power - SET TAKE-OFF POWER (Mixture - SET as required by field elevation)
2. Brakes - RELEASE THEN ACCELERATE to recommended speeds
3. Landing Gear - RETRACT (when positive rate of climb is established and insufficient runway remains for landing)
4. Airspeed - ESTABLISH DESIRED CLIMB SPEED (when clear of obstacles)

CLIMB

Maximum Continuous Full Throttle, 2700 rpm
Cruise Climb 25 in. Hg (or full throttle) 2500 rpm

1. Engine Temperatures - MONITOR
2. Power - SET AS DESIRED.
3. Mixture - SET FUEL FLOW

CRUISE

See Cruise Charts in PERFORMANCE Section.

1. Cowl Flaps - CLOSED
2. Power - SET
3. Mixture - SET FUEL FLOW

LEANING USING THE EXHAUST GAS TEMPERATURE INDICATOR (EGT)

A thermocouple-type exhaust gas temperature (EGT) probe is mounted in the exhaust system. This probe is connected to an indicator on the instrument panel. The indicator is calibrated in degrees Fahrenheit. Use EGT system to lean the fuel/air mixture when cruising at 75% power or less in the following manner:

1. Lean the mixture and note the point on the indicator that the temperature peaks and starts to fall.
 - a. CRUISE (LEAN) MIXTURE - Increases the mixture until the EGT shows a drop of 25°F below peak on the rich side of peak.
 - b. BEST POWER MIXTURE - Increase the mixture until the EGT shows a drop of 100°F below peak on the rich side of peak.

CAUTION

Do not continue to lean mixture beyond that necessary to establish peak temperature.

2. Continuous operation is recommended at 25°F or more below peak EGT only on the rich side of peak.
3. Changes in altitude and power settings require the peak EGT to be rechecked and the mixture reset.

DESCENT

1. Altimeter - SET
2. Cowl Flaps - CLOSED
3. Power - AS REQUIRED (avoid prolonged idle settings and low cylinder head temperatures)
4. Mixture - ENRICH AS REQUIRED

BEFORE LANDING

1. Seat Belts and Shoulder Harnesses - SECURE

NOTE

All reclining seats must be in the upright position during landing.

2. Fuel Selector Valve - SELECT TANK MORE NEARLY FULL
3. Cowl Flaps - AS REQUIRED
4. Mixture - FULL RICH (or as required by field elevation)
5. Landing Gear - DOWN and CHECK. (Observe maximum extension speed)
6. Landing and Taxi Lights - AS REQUIRED
7. Flaps - DOWN (Observe maximum extension speed)
8. Airspeed - ESTABLISH LANDING APPROACH SPEED.
9. Propeller - HIGH RPM
10. Electric Elevator Trim Switch - OFF (if installed)

BALKED LANDING

1. Power - FULL THROTTLE, 2700 RPM
2. Airspeed - 70 kts/81 mph until clear of obstacles, then trim to normal climb speed
3. Flaps - UP
4. Landing Gear - UP
5. Cowl Flaps - OPEN

AFTER LANDING

1. Landing and Taxi Lights - AS REQUIRED
2. Flaps - UP
3. Trim Tab - SET TO 0°
4. Cowl Flaps - OPEN

SHUTDOWN

1. Brakes - SET
2. Electrical and Radio Equipment - OFF
3. Throttle - CLOSE
4. Mixture - IDLE CUT-OFF
5. MagnetoStart Switch - OFF, after engine stops
6. Battery and Alternator Switches - OFF
7. Control Lock - INSTALL, if conditions warrant.
8. Install wheel chocks and release brakes if the airplane is to be left unattended.

ENVIRONMENTAL SYSTEMS

OXYGEN SYSTEM

PREFLIGHT

1. Check Oxygen Pressure Gage for pressure reading.
2. Determine percent of full system.
3. Multiply oxygen duration in minutes by percent of full bottle.

EXAMPLE:

People	5
Gage Pressure	1500 psig
Oxygen Available (from chart)	80%
Cylinder Capacity (full)	49 cu ft
Altitude (planned flight)	15,000 ft
Full Bottle Duration (from chart)	149 min
Duration (80% full)	119 min

**OXYGEN AVAILABLE WITH
PARTIALLY FULL BOTTLE**

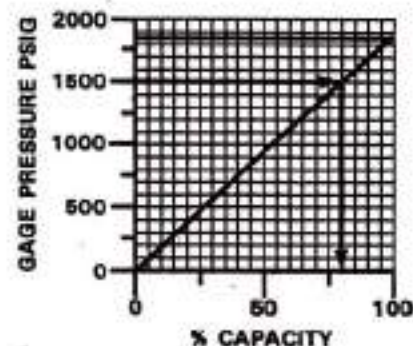

OXYGEN DURATION

The recommended masks are provided with the system. They are designed to be adjustable to fit the average person, with minimum leakage of oxygen.

CAUTION

Since 90% of the system efficiency is determined by the fit of the oxygen mask, make certain the masks fit properly and are in good condition.



SECTION V PERFORMANCE

TABLE OF CONTENTS

SUBJECT	PAGE
Introduction to Performance and Flight Planning	5-3
Comments Pertinent to the Use of Performance Graphs.....	5-9
Airspeed Calibration - Normal System	5-12
Altimeter Correction - Normal System.....	5-13
Airspeed Calibration - Alternate System	5-14
Altimeter Correction - Alternate System.....	5-15
ISA Conversion.....	5-16
Fahrenheit to Celsius Temperature Conversion.....	5-17
Stall Speeds - Power Idle.....	5-18
Manifold Pressure Vs RPM.....	5-19
Wind Components.....	5-20
Take-off Distance - Flaps Up.....	5-22
Take-off Distance - Flaps Approach.....	5-23
Climb	5-24
Time, Fuel, and Distance to Cruise Climb	5-25

Except as noted, all airspeeds quoted in this Section are indicated airspeeds (IAS) and assume zero instrument error.

INTRODUCTION TO PERFORMANCE AND FLIGHT PLANNING

The graphs and tables in this section present performance information for flight planning at various parameters of weight, power, altitude, and temperature. Examples have been presented on all performance graphs. In addition, the calculations for flight time, block speed, and fuel required for a proposed flight are detailed below. All examples and calculations utilize the following conditions:

CONDITIONS

At Stapleton International (DEN):

Outside Air Temperature	15°C (59°F)
Field Elevation.....	5333 ft'
Altimeter Setting.....	29.60 in. Hg
Runway 26L length.....	10,004 ft'

¹Source: Jeppesen Approach Chart, Nov 14-80

Route of Trip²

DEN-V81-AMA

At Amarillo International (AMA):

At Amarillo:

Outside Air Temperature	25°C (77°F)
Field Elevation.....	3605 ft'
Altimeter Setting.....	29.56 in. Hg
Wind.....	190° at 12 kts
Runway 22 Length	13,502 ft'

²Source: Jeppesen Approach Chart, Dec 21-79

Section V
Performance

BEECHCRAFT
Bonanza A36

Route Segment Data:

ROUTE SEGMENT	AVERAGE MAGNETIC COURSE	AVERAGE MAGNETIC VARIATION	DIST NM	WIND AT 11,500 FT DIR/KTS	OAT AT 11,500 FT °C
DEN-COS	155°	12°E	51	010°/30	-5
COS-PUB	153°	12°E	40	010°/30	-5
PUB-TBE	135°	12°E	74	100°/20	0
TBE-DHT	132°	11°E	87	200°/20	9
DHT-AMA	126°	10°E	70*	200°/20	10

*Source: Jeppesen Low Altitude Enroute Charts US (LO) 11 and 12, Oct 3-80

*Includes distance between airport and VORTAC, per Jeppesen Airport Directory, 1980

PRESSURE ALTITUDE

To determine pressure altitude at origin and destination airports, add 1000 feet to field elevation for each 1.00 in. Hg below 29.92, and subtract 1000 feet from field elevation for each 1.00 in. Hg above 29.92.

Pressure Altitude at DEN:

$$29.92 - 29.60 = .32 \text{ in. Hg}$$

$$.32 \times 1000 = 320 \text{ feet}$$

The Pressure Altitude at DEN is 320 feet above the field elevation.

$$5333 + 320 = 5653 \text{ feet}$$

BEECHCRAFT
Bonanza A36

Section V
Performance

Pressure Altitude at AMA:

$$29.92 - 29.56 = .36 \text{ in. Hg}$$

$$.36 \times 1000 = 360 \text{ feet}$$

The Pressure Altitude at AMA is 360 feet above the field elevation.

$$3605 + 360 = 3965 \text{ feet}$$

NOTE

For flight planning, the difference between cruise altitude and cruise pressure altitude has been ignored.

CALCULATIONS FOR FLIGHT TIME, BLOCK SPEED AND FUEL REQUIREMENT

CRUISE CLIMB

Enter the TIME, FUEL, AND DISTANCE TO CRUISE CLIMB Graph at 15°C to 5853 ft and 3650 lbs, and again at -5°C to 11,500 ft and 3850 lbs. and read:

$$\text{Time to Climb} = 18.0 - 6.5 = 11.5 \text{ MIN}$$

$$\text{Fuel Used to Climb} = 6.0 - 2.5 = 3.5 \text{ GAL}$$

$$\text{Distance Traveled} = 36.0 - 12.5 = 23.5 \text{ NM}$$

Section V
Performance

BEECHCRAFT
Bonanza A36

CRUISE

The temperatures for cruise are presented for a Standard Day (ISA); 20°C (36°F) above a Standard Day (ISA + 20°C); and 20°C (36°F) below a Standard Day (ISA - 20°C). These should be used for flight planning. The IOAT values are true temperature values which have been adjusted for the compressibility effects. IOAT should be used for setting cruise power while enroute.

Enter the ISA CONVERSION Graph at 11,500 feet and the temperature for the route segment:

DEN-PUB	OAT	=	-5°C
	ISA Condition	=	ISA + 3°C
PUB-TBE	OAT	=	0°C
	ISA Condition	=	ISA + 8°C
TBE-DHT	OAT	=	9°C
	ISA Condition	=	ISA + 17°C
DHT-AMA	OAT	=	10°C
	ISA Condition	=	ISA + 18°C

Enter the MAXIMUM CRUISE POWER Table at 10,000 ft and at 12,000 ft at ISA and ISA + 20°C:

ALTITUDE FEET	TEMPERATURE			
	ISA		ISA + 20°C	
	FUEL FLOW GAL/HR	TAS KNOTS	FUEL FLOW GAL/HR	TAS KNOTS
10,000	14.5	171	14.0	171
12,000	13.5	167	13.0	167

BEECHCRAFT
Bonanza A36

Section V
Performance

Interpolate for 11,500 feet and the temperature for the appropriate route segment. Results of the interpolations are:

ROUTE SEGMENT	ISA CONDITION	FUEL FLOW GPH	TAS KNOTS
DEN-PUB	ISA + 3°C	13.7	168
PUB-TBE	ISA + 8°C	13.6	168
TBE-DHT	ISA + 17°C	13.4	168
DHT-AMA	ISA + 18°C	13.3	168

Time and fuel used were calculated as follows:

$$\text{Time} = \frac{\text{Distance}}{\text{Ground Speed}}$$

$$\text{Fuel Used} = \frac{\text{Distance}}{\text{Ground speed}} \times \text{Fuel Flow}$$

Results are:

ROUTE SEGMENT	DISTANCE NM	EST GROUND SPEED KNOTS	TIME AT CRUISE ALTITUDE HRS:MIN	FUEL USED CRUISE GAL
DEN-COS	51-23.5 = 27.5*	195	:08.5	2.0
COS-PUB		195	:12	2.9
PUB-TBE	40	154	:29	6.6
TBE-DHT	74	156	:33.5	7.5
DHT-AMA	87	158	:27	5.9

*Distance required to climb has been subtracted from segment distance.

TIME - FUEL - DISTANCE - CHART			
ITEM	TIME HRS:MINS	FUEL GAL	DISTANCE NM
Start, Runup, Taxi, and Take- off acceleration	0:00	2.2	0
Climb	:11.5	3.5	23.5
Cruise	1:49.7	24.9	298.5
Total	2:01.2	30.6	322

Total Flight Time: 2 hours, 1.2 minutes

Block Speed: 322 NM + 2 hours, 1.2 minutes = 159 knots

RESERVE FUEL

Enter the ECONOMY CRUISE POWER Table at ISA and ISA + 20°C at 10,000 feet and 12,000 feet. Interpolate to find the Fuel Flow at 11,500 feet at ISA + 18°C:

Total Fuel Flow 9.3 GPH

Reserve Fuel (45 minutes) (9.3 GPH) = 7.0 gallons

TOTAL FUEL REQUIREMENT

30.6 + 7.0 = 37.6 gallons

LANDING WEIGHT

The estimated landing weight is determined by subtracting the fuel required for the trip from the ramp weight:

Assumed Ramp Weight = 3663 pounds
 Estimated fuel from DEN to AMA = 30.6 gallons @ 6
 lb/gal = 183.6 = 184 pounds
 Estimated Landing Weight = 3663 - 184 = 3479
 pounds

**COMMENTS PERTINENT TO THE USE OF
PERFORMANCE GRAPHS**

1. In addition to presenting the answer for a particular set of conditions the example on the graph also presents the order in which the various scales on the graph should be used. For instance, if the first item in the example is OAT, then enter the graph at the known OAT and proceed to the remaining item(s) in the example in the order given.
2. The reference lines indicate where to begin following guidelines. Always project to the reference line first, then follow the guideline to the next known item.
3. Indicated airspeeds (IAS) were obtained by using the AIRSPEED CALIBRATION - NORMAL SYSTEM Graph.
4. The associated conditions define the specific conditions from which performance parameters have been determined. They are not intended to be used as instructions; however, performance values determined from charts can only be achieved if the specified conditions exist.

AIRSPEED CALIBRATION - NORMAL SYSTEM

NOTE: INDICATED AIRSPEED ASSUMES ZERO INSTRUMENT ERROR

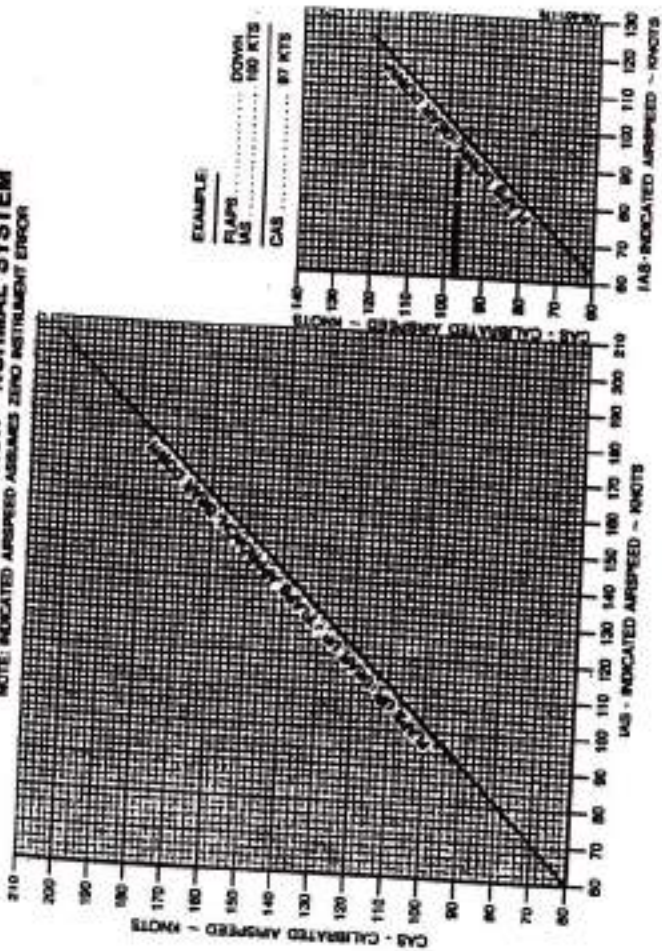

ALTIMETER CORRECTION - NORMAL SYSTEM

NOTE: INDICATED AIRSPEED AND INDICATED ALTITUDE ASSUME ZERO INSTRUMENT ERROR

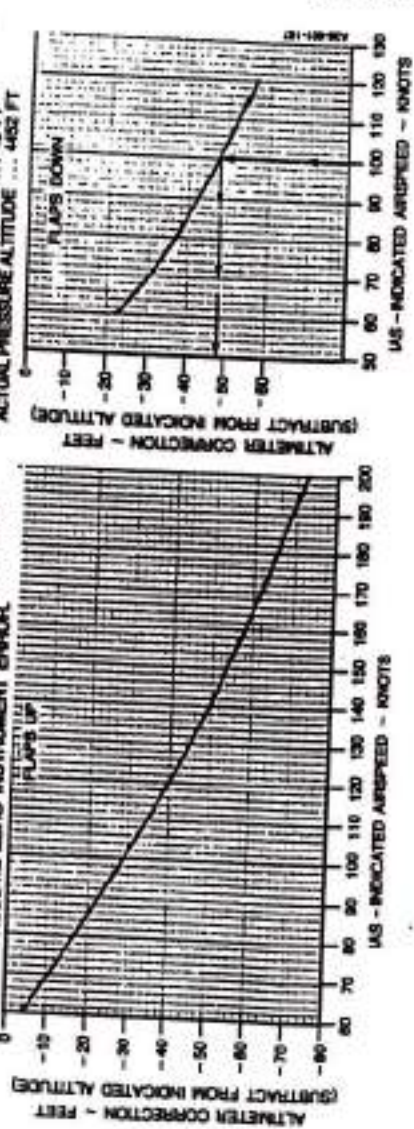

AIRSPEED CALIBRATION - ALTERNATE SYSTEM

ALL FLAP POSITIONS

- NOTES:
 1. INDICATED AIRSPEED ASSUMES ZERO INSTRUMENT ERROR.
 2. NORMAL STATIC PORTS ARE CONSTRUCTED.

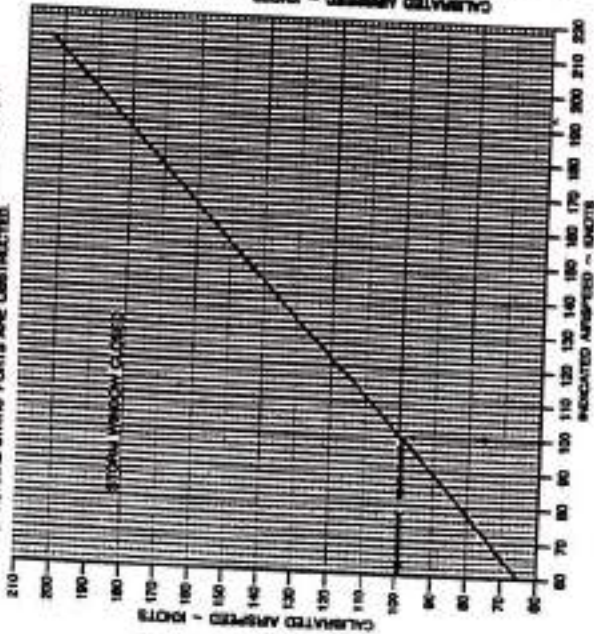

Section V Performance

EXAMPLE:
 IAS 100 KNOTS
 STORM WINDOW CLOSED
 CAS 99.5 KNOTS

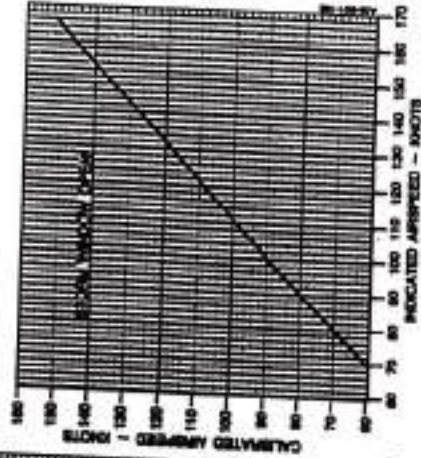

BEECHCRAFT Bonanza A36

BEECHCRAFT Bonanza A36

Section V Performance

ALTIMETER CORRECTION - ALTERNATE SYSTEM

ALL FLAP POSITIONS

- NOTES:
 1. INDICATED AIRSPEED AND INDICATED ALTITUDE ASSUME ZERO INSTRUMENT ERROR.
 2. NORMAL STATIC PORTS ARE CONSTRUCTED.

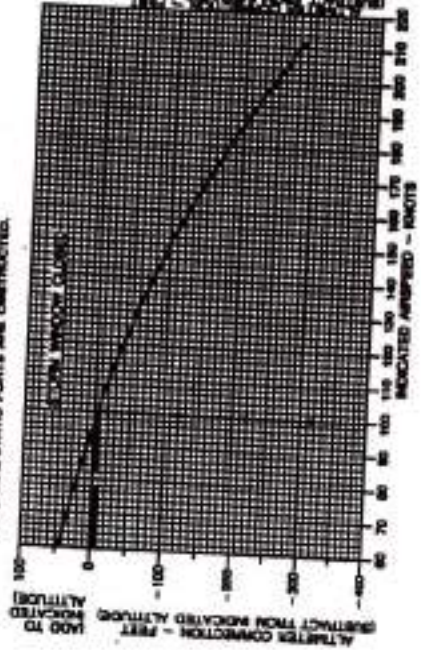

EXAMPLE:
 IAS 100 KNOTS
 STORM WINDOW CLOSED
 INDICATED PRESSURE ALTITUDE 8000 FEET
 ALTITUDE CORRECTION -87 FEET
 ACTUAL PRESSURE ALTITUDE 8084 FEET

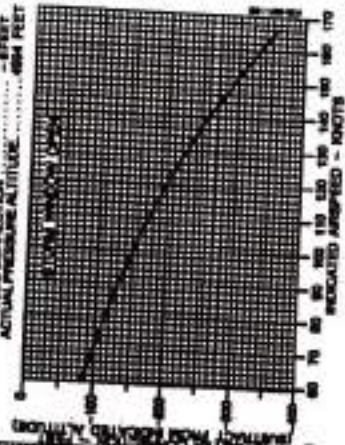

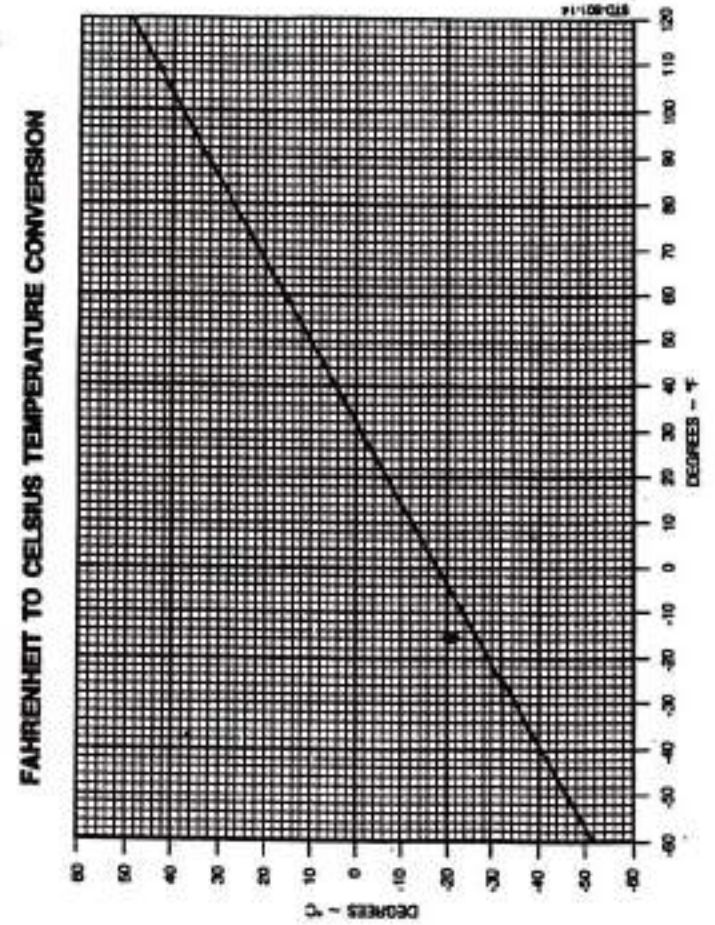
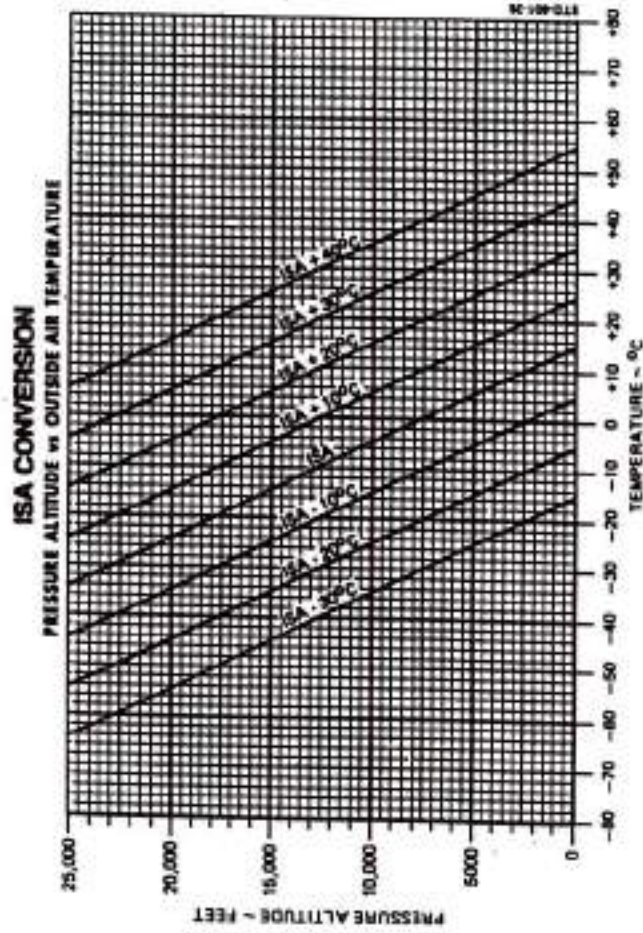

Section V
Performance

BEECHCRAFT
Bonanza A36

STALL SPEEDS - POWER IDLE

Notes: 1. THE MAXIMUM ALTITUDE LOSS EXPERIENCED WHILE CONDUCTING STALLS IN ACCORDANCE WITH CAR 3.120 WAS 300 FEET.

2. THESE STALL SPEEDS WERE DETERMINED AT THE FORWARD CENTER OF GRAVITY AND 1000 FEET EACH WEIGHT. AT SOME LOADINGS THE AIRPLANE IS ELEVATOR LIMITED, RESULTING IN A MAXIMUM STEADY SPEED RATHER THAN A STALL.

EXAMPLE:
WEIGHT 3500 LBS
FLAPS 0°
BANK ANGLE 30°

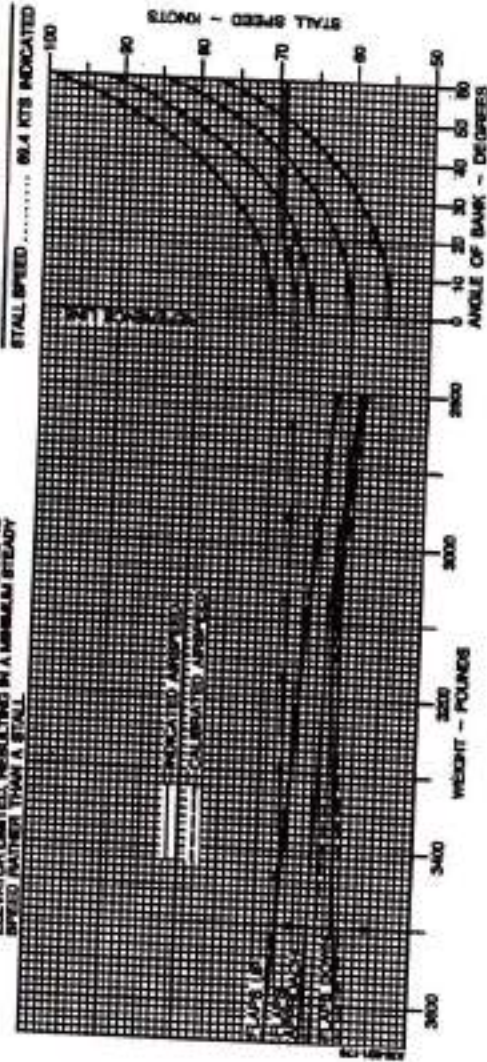

BEECHCRAFT
Bonanza A36

Section V
Performance

MANIFOLD PRESSURE VS RPM

NOTE: OPERATION AT MIXTURE SETTINGS LEANER THAN 27°C LEAN OF PEAK EGT IS PROHIBITED.

EXAMPLE:

ENGINE SPEED 2300 RPM
MANIFOLD PRESSURE 23 IN. HG
MIXTURE SETTING 20°C LEAN OF PEAK EGT

WITHIN RECOMMENDED LIMITS

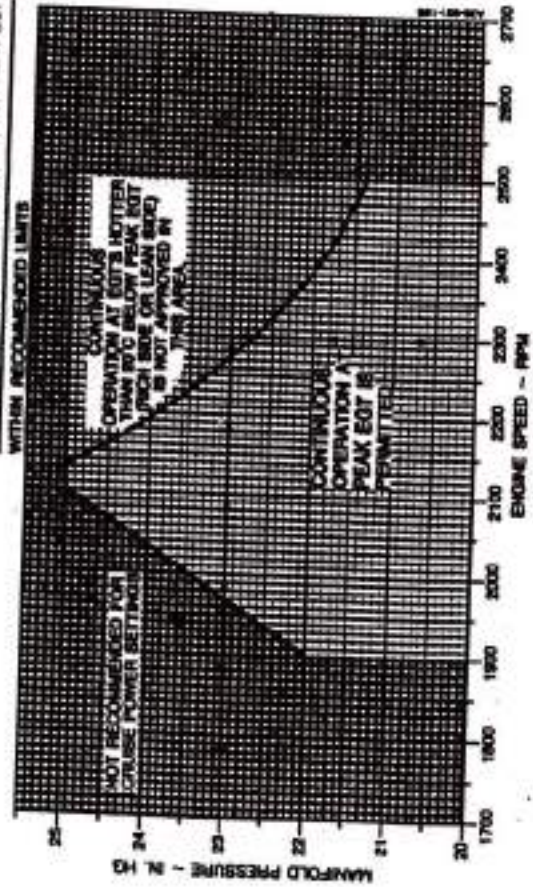

TAKE-OFF DISTANCE - FLAPS UP

ASSUMED CONDITIONS

POWER: TAKE-OFF POWER SET BEFORE BRAKE RELEASE
FULL ICE-0, 100% EAS, 5.00L, 5.00L, 5.00L, 5.00L
AS REQUIRED BY AIRPORT OBSTACLE LIMITS
FLAPS: LANDING GEAR
CLIMB FLAPS: OPEN
RETRACT AFTER POSITIVE CLIMB ESTABLISHED
WIND: HEADWIND
PITCH: LEVEL, DRY SURFACE

EXAMPLE:
GAT: 1000 FT
SLASH: 1000 FT
HEADWIND COMPONENT: 10 KTS
TOTAL OBSTACLE CLEARANCE: 1000 FT
TAKE-OFF SPEED AT 1000 FT: 100 KTS
AS REQUIRED

WEIGHT - POUNDS	TAKE-OFF SPEED	
	VELOCITY - KNOTS	MPH
1000	100	115
1100	105	120
1200	110	125
1300	115	130
1400	120	135
1500	125	140
1600	130	145
1700	135	150
1800	140	155
1900	145	160
2000	150	165

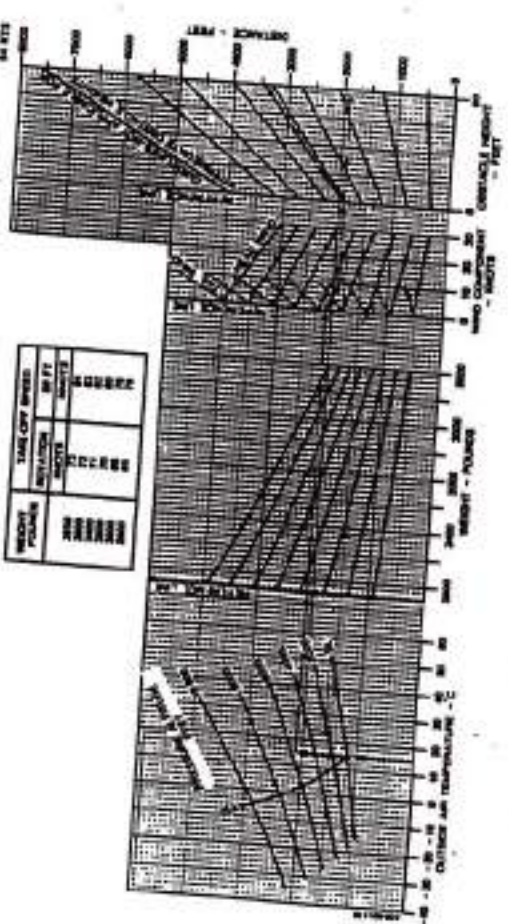

TAKE-OFF DISTANCE - FLAPS APPROACH

ASSUMED CONDITIONS

POWER: TAKE-OFF POWER SET BEFORE BRAKE RELEASE
FULL ICE-0, 100% EAS, 5.00L, 5.00L, 5.00L, 5.00L
AS REQUIRED BY AIRPORT OBSTACLE LIMITS
FLAPS: LANDING GEAR
CLIMB FLAPS: OPEN
RETRACT AFTER POSITIVE CLIMB ESTABLISHED
WIND: HEADWIND
PITCH: LEVEL, DRY SURFACE

EXAMPLE:
GAT: 1000 FT
SLASH: 1000 FT
HEADWIND COMPONENT: 10 KTS
TOTAL OBSTACLE CLEARANCE: 1000 FT
TAKE-OFF SPEED AT 1000 FT: 100 KTS
AS REQUIRED

WEIGHT - POUNDS	TAKE-OFF SPEED	
	VELOCITY - KNOTS	MPH
1000	100	115
1100	105	120
1200	110	125
1300	115	130
1400	120	135
1500	125	140
1600	130	145
1700	135	150
1800	140	155
1900	145	160
2000	150	165

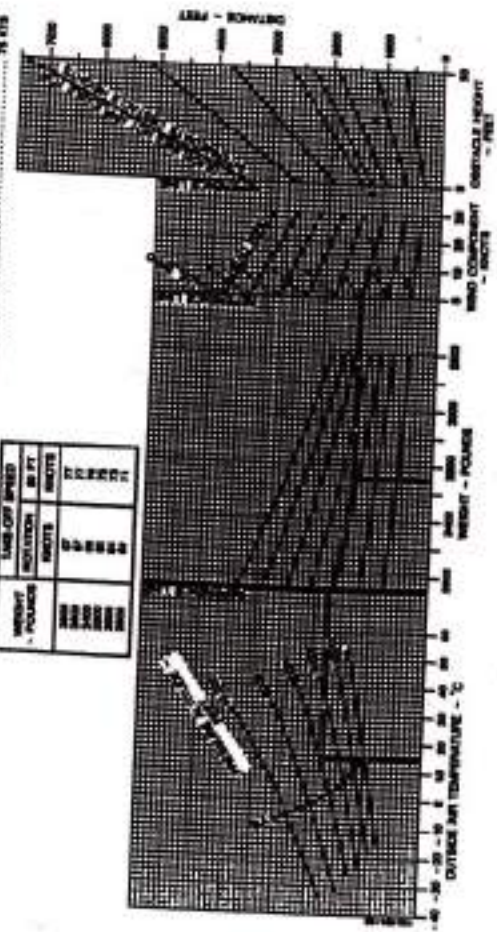

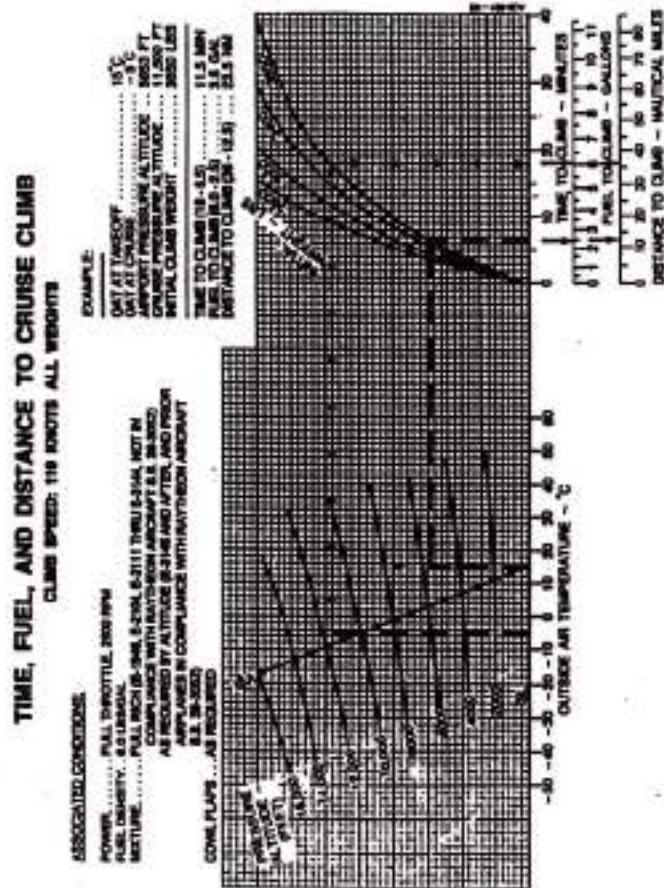
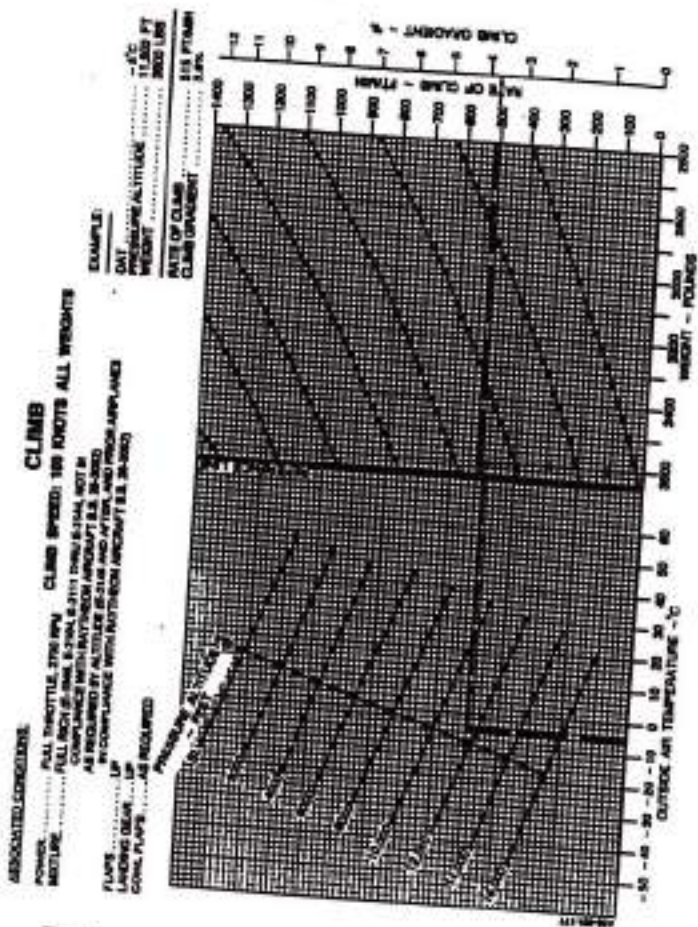

Section V
Performance

BEECHCRAFT
Bonanza A36

MAXIMUM RECOMMENDED CRUISE POWER SETTINGS

20°C RICH

25.0 IN. HG (OR FULL THROTTLE) @ 2500 RPM
CRUISE RICH MIXTURE
3400 LBS.

OF PEAK EGT

	PRESS. ALT		IOAT		MAN. PRESS. IN. HG	FUEL FLOW		AIR-SPEED	
	FEET		°C	°F		PPH	GPH	KIAS	KTAS
ISA - 20° C (ISA - 36° F)	SL	-3	27	25.0	102.1	17.0	172	164	
	2000	-6	21	25.0	105.8	17.8	172	166	
	4000	-10	14	25.0	109.1	18.2	172	174	
	6000	-14	7	24.1	106.7	17.7	169	175	
	8000	-18	1	22.3	97.7	16.9	162	172	
	10,000	-22	-5	20.6	90.2	16.0	155	170	
STANDARD DAY (ISA)	SL	18	64	25.0	98.1	16.4	167	165	
	2000	14	57	25.0	101.3	16.9	167	170	
	4000	10	50	25.0	104.8	17.4	167	175	
	6000	6	43	24.1	101.6	17.0	164	176	
	8000	2	36	22.3	93.9	16.2	157	174	
	10,000	-2	28	20.6	86.9	14.5	150	171	
ISA + 20° C (ISA + 36° F)	SL	38	100	25.0	94.1	15.7	163	166	
	2000	34	93	25.0	97.2	16.2	163	171	
	4000	30	86	25.0	100.3	16.7	162	176	
	6000	26	79	24.1	97.7	16.3	159	177	
	8000	22	72	22.3	90.2	15.1	152	174	
	10,000	18	64	20.6	83.8	14.0	144	171	
ISA - 20° C (ISA - 36° F)	SL	-3	27	25.0	102.1	17.0	172	164	
	2000	-6	21	25.0	105.8	17.8	172	166	
	4000	-10	14	25.0	109.1	18.2	172	174	
	6000	-14	7	24.1	106.7	17.7	169	175	
	8000	-18	1	22.3	97.7	16.9	162	172	
	10,000	-22	-5	20.6	90.2	16.0	155	170	
STANDARD DAY (ISA)	SL	18	64	25.0	98.1	16.4	167	165	
	2000	14	57	25.0	101.3	16.9	167	170	
	4000	10	50	25.0	104.8	17.4	167	175	
	6000	6	43	24.1	101.6	17.0	164	176	
	8000	2	36	22.3	93.9	16.2	157	174	
	10,000	-2	28	20.6	86.9	14.5	150	171	
ISA + 20° C (ISA + 36° F)	SL	38	100	25.0	94.1	15.7	163	166	
	2000	34	93	25.0	97.2	16.2	163	171	
	4000	30	86	25.0	100.3	16.7	162	176	
	6000	26	79	24.1	97.7	16.3	159	177	
	8000	22	72	22.3	90.2	15.1	152	174	
	10,000	18	64	20.6	83.8	14.0	144	171	

NOTES:

1. Full throttle manifold pressure settings are approximate.
2. Shaded area represents operation with full throttle.
3. Fuel flows are to be used for flight planning only and will vary from airplane to airplane. Lean using the EGT.

BEECHCRAFT
Bonanza A36

Section V
Performance

RECOMMENDED CRUISE POWER SETTINGS

20°C LEAN

25.0 IN. HG (OR FULL THROTTLE) @ 2500 RPM
CRUISE LEAN MIXTURE
3400 LBS.

OF PEAK EGT

	PRESS. ALT		IOAT		MAN. PRESS. IN. HG	FUEL FLOW		AIR-SPEED	
	FEET		°C	°F		PPH	GPH	KIAS	KTAS
ISA - 20° C (ISA - 36° F)	SL	-3	27	25.0	86.3	14.4	168	159	
	2000	-6	20	25.0	88.3	14.9	168	164	
	4000	-10	13	25.0	92.3	15.4	168	169	
	6000	-14	6	24.1	89.3	15.0	164	170	
	8000	-18	-1	22.3	82.6	13.9	157	166	
	10,000	-22	-7	20.6	76.0	12.7	150	163	
STANDARD DAY (ISA)	SL	17	63	25.0	82.9	13.8	163	160	
	2000	14	56	25.0	85.6	14.3	163	165	
	4000	10	50	25.0	88.5	14.8	163	170	
	6000	6	43	24.1	85.3	14.4	159	171	
	8000	2	36	22.3	78.6	13.2	152	168	
	10,000	-2	28	20.6	72.0	12.0	144	165	
ISA + 20° C (ISA + 36° F)	SL	37	99	25.0	79.5	13.3	158	161	
	2000	34	92	25.0	82.1	13.7	158	166	
	4000	30	86	25.0	84.7	14.1	158	171	
	6000	26	79	24.1	81.5	13.5	154	172	
	8000	22	72	22.3	74.8	12.3	147	169	
	10,000	18	64	20.6	70.5	11.9	140	165	
ISA - 20° C (ISA - 36° F)	SL	-3	27	25.0	86.3	14.4	168	159	
	2000	-6	20	25.0	88.3	14.9	168	164	
	4000	-10	13	25.0	92.3	15.4	168	169	
	6000	-14	6	24.1	89.3	15.0	164	170	
	8000	-18	-1	22.3	82.6	13.9	157	166	
	10,000	-22	-7	20.6	76.0	12.7	150	163	
STANDARD DAY (ISA)	SL	17	63	25.0	82.9	13.8	163	160	
	2000	14	56	25.0	85.6	14.3	163	165	
	4000	10	50	25.0	88.5	14.8	163	170	
	6000	6	43	24.1	85.3	14.4	159	171	
	8000	2	36	22.3	78.6	13.2	152	168	
	10,000	-2	28	20.6	72.0	12.0	144	165	
ISA + 20° C (ISA + 36° F)	SL	37	99	25.0	79.5	13.3	158	161	
	2000	34	92	25.0	82.1	13.7	158	166	
	4000	30	86	25.0	84.7	14.1	158	171	
	6000	26	79	24.1	81.5	13.5	154	172	
	8000	22	72	22.3	74.8	12.3	147	169	
	10,000	18	64	20.6	70.5	11.9	140	165	

NOTES:

1. Full throttle manifold pressure settings are approximate.
2. Shaded area represents operation with full throttle.
3. Fuel flows are to be used for flight planning only and will vary from airplane to airplane. Lean using the EGT.

Section V
Performance

BEECHCRAFT
Bonanza A36

RECOMMENDED CRUISE POWER SETTINGS

20°C RICH

OF PEAK EGT

23.0 IN. HG (OR FULL THROTTLE) @ 2300 RPM
CRUISE RICH MIXTURE
3400 LBS

	PRESS. ALT	IOAT		MAN. PRESS.	FUEL FLOW		AIR-SPEED	
	FEET	°C	°F	IN. HG	PPH	GPH	KIAS	KTAS
ISA - 20° C (ISA - 30° F)	SL	-3	27	23.0	81.8	13.8	158	150
	2000	-7	20	23.0	84.2	14.0	158	154
	4000	-11	13	23.0	86.9	14.5	158	158
	6000	-14	6	23.0	89.7	15.0	158	164
	8000	-18	0	23.0	92.5	15.5	158	168
	10,000	-22	-4	23.0	95.3	16.0	158	172
STANDARD DAY (ISA)	SL	17	63	23.0	78.0	13.2	153	150
	2000	13	56	23.0	81.4	13.6	153	155
	4000	9	49	23.0	83.9	14.0	153	160
	6000	6	42	23.0	86.5	14.4	153	165
	8000	3	35	23.0	89.0	14.8	153	170
	10,000	0	28	23.0	91.5	15.2	153	175
ISA + 20° C (ISA + 30° F)	SL	37	99	23.0	78.5	12.8	148	151
	2000	33	92	23.0	78.7	13.1	148	155
	4000	29	85	23.0	81.0	13.5	148	160
	6000	25	78	23.0	83.4	13.9	148	165
	8000	22	71	23.0	85.8	14.3	148	170
	10,000	18	64	23.0	88.2	14.7	148	175

NOTES:

1. Full throttle manifold pressure settings are approximate.
2. Shaded area represents operation with full throttle.
3. Fuel flows are to be used for flight planning only and will vary from airplane to airplane. Lean using the EGT.

BEECHCRAFT
Bonanza A36

Section V
Performance

RECOMMENDED CRUISE POWER SETTINGS

20°C LEAN

OF PEAK EGT

23.0 IN. HG (OR FULL THROTTLE) @ 2300 RPM
CRUISE LEAN MIXTURE
3400 LBS

	PRESS. ALT	IOAT		MAN. PRESS.	FUEL FLOW		AIR-SPEED	
	FEET	°C	°F	IN. HG	PPH	GPH	KIAS	KTAS
ISA - 20° C (ISA - 30° F)	SL	-3	25	23.0	67.8	11.3	152	144
	2000	-7	20	23.0	69.7	11.6	152	148
	4000	-11	13	23.0	72.1	12.0	153	154
	6000	-15	6	23.0	74.4	12.4	153	158
	8000	-19	0	23.0	76.7	12.8	153	162
	10,000	-23	-4	23.0	79.0	13.2	153	166
STANDARD DAY (ISA)	SL	17	62	23.0	65.4	10.8	147	145
	2000	13	56	23.0	67.4	11.2	147	148
	4000	9	49	23.0	69.4	11.6	148	154
	6000	5	42	23.0	71.7	12.0	148	159
	8000	2	36	23.0	73.9	12.4	148	164
	10,000	-1	29	23.0	76.2	12.8	148	169
ISA + 20° C (ISA + 30° F)	SL	37	98	23.0	63.2	10.5	142	145
	2000	33	92	23.0	65.1	10.9	143	148
	4000	29	85	23.0	67.1	11.2	143	154
	6000	25	78	23.0	69.0	11.6	143	158
	8000	22	71	23.0	70.8	12.0	143	162
	10,000	18	63	23.0	72.7	12.4	143	166

NOTES:

1. Full throttle manifold pressure settings are approximate.
2. Shaded area represents operation with full throttle.
3. Fuel flows are to be used for flight planning only and will vary from airplane to airplane. Lean using the EGT.

Section V
Performance

BEECHCRAFT
Bonanza A36

RECOMMENDED CRUISE POWER SETTINGS

20°C RICH

25.0 IN. HG (OR FULL THROTTLE) @ 2100 RPM
CRUISE RICH MIXTURE
3400 LBS

OF PEAK EGT

PRESS. ALT FEET	IOAT		MAN. PRESS. IN. HG	FUEL FLOW		AIR-SPEED	
	°C	°F		PPH	GPH	KIAS	KTAS
ISA - 20° C (ISA - 36° F)							
SL	-3	27	25.0	78.5	13.3	155	148
2000	-7	20	25.0	82.6	13.8	156	153
4000	-11	13	25.0	85.8	14.3	157	158
6000	-15	6	24.3	85.1	14.2	154	159
8000	-19	-2	22.8	78.5	13.3	143	137
10,000	-23	-9	20.8	74.9	12.8	130	125
12,000	-27	-16	19.3	70.4	11.8	119	114
14,000	-31	-23	17.9	66.1	11.0	107	102
16,000	-35	-31	16.5	61.9	10.3	101	96
STANDARD DAY (ISA)							
SL	17	63	25.0	77.0	12.8	150	148
2000	13	56	25.0	79.9	13.3	151	153
4000	9	49	25.0	82.9	13.8	152	158
6000	5	42	24.3	82.3	13.7	149	150
8000	-3	35	22.8	77.0	12.8	142	137
10,000	-7	27	20.8	72.9	12.2	134	129
12,000	-11	20	19.3	68.5	11.6	126	121
14,000	-15	12	17.9	64.3	11.0	118	113
16,000	-19	5	16.5	60.1	10.3	111	106
ISA + 20° C (ISA + 36° F)							
SL	37	98	25.0	74.9	12.5	148	148
2000	33	92	25.0	77.3	12.9	146	153
4000	29	85	25.0	80.1	13.4	146	158
6000	25	78	24.3	79.5	13.3	143	150
8000	21	71	22.8	74.9	12.5	136	137
10,000	17	63	20.8	71.0	11.8	128	129
12,000	13	56	19.3	66.1	11.0	119	121
14,000	9	48	17.9	61.9	10.3	110	113
16,000	5	41	16.5	57.7	9.6	103	106

NOTES:

1. Full throttle manifold pressure settings are approximate.
2. Shaded area represents operation with full throttle.
3. Fuel flows are to be used for flight planning only and will vary from airplane to airplane. Lean using the EGT.

5-30

October, 1983

BEECHCRAFT
Bonanza A36

Section V
Performance

RECOMMENDED CRUISE POWER SETTINGS

20°C LEAN

25.0 IN. HG (OR FULL THROTTLE) @ 2100 RPM
CRUISE LEAN MIXTURE
3400 LBS

OF PEAK EGT

PRESS. ALT FEET	IOAT		MAN. PRESS. IN. HG	FUEL FLOW		AIR-SPEED	
	°C	°F		PPH	GPH	KIAS	KTAS
ISA - 20° C (ISA - 36° F)							
SL	-3	23	25.0	63.8	10.8	148	140
2000	-7	16	25.0	66.4	11.1	149	145
4000	-11	12	25.0	68.9	11.5	149	150
6000	-15	8	24.3	68.3	11.4	147	152
8000	-19	4	22.8	65.9	10.7	139	146
10,000	-23	0	20.8	60.1	10.0	132	134
12,000	-27	-4	19.3	54.7	9.3	123	126
14,000	-31	-8	17.9	49.5	8.7	115	118
16,000	-35	-12	16.5	44.3	8.0	107	111
STANDARD DAY (ISA)							
SL	17	62	25.0	61.9	10.3	143	140
2000	13	55	25.0	64.2	10.7	143	145
4000	9	48	25.0	66.6	11.1	144	150
6000	5	44	24.3	66.1	11.0	141	152
8000	-3	39	22.8	61.9	10.3	134	148
10,000	-7	34	20.8	56.5	9.6	126	133
12,000	-11	29	19.3	51.3	8.9	118	124
14,000	-15	24	17.9	46.1	8.2	109	115
16,000	-19	19	16.5	40.9	7.5	101	106
ISA + 20° C (ISA + 36° F)							
SL	37	98	25.0	60.1	10.0	138	140
2000	33	91	25.0	62.1	10.4	138	145
4000	29	84	25.0	64.4	10.7	139	150
6000	25	77	24.3	63.9	10.7	136	151
8000	21	70	22.8	60.2	10.0	128	147
10,000	17	63	20.8	56.6	9.6	119	141
12,000	13	55	19.3	51.5	9.1	108	131
14,000	9	48	17.9	46.3	8.4	100	106
16,000	5	41	16.5	41.1	7.7	92	98

NOTES:

1. Full throttle manifold pressure settings are approximate.
2. Shaded area represents operation with full throttle.
3. Fuel flows are to be used for flight planning only and will vary from airplane to airplane. Lean using the EGT.

October, 1983

5-31

Section V
Performance

BEECHCRAFT
Bonanza A36

RECOMMENDED CRUISE POWER SETTINGS

20°C RICH

21.0 IN. HG (OR FULL THROTTLE) @ 2100 RPM
CRUISE RICH MIXTURE
3400 LBS

OF PEAK EGT

	PRESS. ALT.	IOAT		MAN. PRESS.	FUEL FLOW		AIR-SPEED	
	FEET	°C	°F	IN. HG	PPH	GPH	KTAS	KTAS
ISA - 20° C (ISA - 30° F)	SL	-4	25	21.0	66.0	11.0	135	128
	2000	-7	19	21.0	67.5	11.3	137	134
	4000	-11	12	21.0	69.3	11.6	138	139
	6000	-15	5	21.0	71.1	11.9	139	144
	8000	-19	-2	21.0	73.4	12.2	140	149
	10,000	-23	-8	21.0	76.0	12.5	140	153
STANDARD DAY (ISA)	SL	17	62	21.0	65.2	10.9	130	127
	2000	13	55	21.0	66.3	11.1	131	133
	4000	8	48	21.0	67.9	11.3	133	138
	6000	3	41	21.0	69.7	11.6	134	144
	8000	-1	34	21.0	71.5	11.9	135	149
	10,000	-5	27	21.0	73.9	12.2	134	153
ISA + 20° C (ISA + 30° F)	SL	38	98	21.0	64.5	10.8	124	126
	2000	33	91	21.0	65.5	10.9	126	132
	4000	29	84	21.0	66.6	11.1	127	137
	6000	25	77	21.0	68.3	11.4	128	143
	8000	21	70	21.0	70.0	11.7	129	148
	10,000	17	63	21.0	71.0	11.8	128	152

- NOTES:
1. Full throttle manifold pressure settings are approximate.
 2. Shaded area represents operation with full throttle.
 3. Fuel flows are to be used for flight planning only and will vary from airplane to airplane. Lean using the EGT.

BEECHCRAFT
Bonanza A36

Section V
Performance

ECONOMY CRUISE POWER SETTINGS

20°C LEAN

21.0 IN. HG (OR FULL THROTTLE) @ 2100 RPM
CRUISE LEAN MIXTURE
3400 LBS

OF PEAK EGT

	PRESS. ALT.	IOAT		MAN. PRESS.	FUEL FLOW		AIR-SPEED	
	FEET	°C	°F	IN. HG	PPH	GPH	KTAS	KTAS
ISA - 20° C (ISA - 30° F)	SL	-4	25	21.0	52.7	8.8	126	120
	2000	-8	18	21.0	54.0	9.0	128	125
	4000	-11	12	21.0	55.4	9.2	130	130
	6000	-15	5	21.0	56.9	9.5	131	136
	8000	-19	-2	21.0	58.9	9.8	132	141
	10,000	-23	-8	21.0	61.1	10.1	132	144
STANDARD DAY (ISA)	SL	18	61	21.0	51.8	8.8	120	118
	2000	12	54	21.0	53.1	8.9	123	124
	4000	8	48	21.0	54.4	9.1	124	129
	6000	3	41	21.0	55.7	9.3	125	134
	8000	-1	34	21.0	57.3	9.5	126	140
	10,000	-5	27	21.0	59.3	9.8	126	143
ISA + 20° C (ISA + 30° F)	SL	38	97	21.0	50.8	8.5	114	115
	2000	32	90	21.0	52.1	8.7	116	121
	4000	29	83	21.0	53.4	8.9	118	127
	6000	25	77	21.0	54.7	9.1	119	132
	8000	21	70	21.0	55.9	9.3	120	137
	10,000	17	63	21.0	58.3	9.5	119	141

- NOTES:
1. Full throttle manifold pressure settings are approximate.
 2. Shaded area represents operation with full throttle.
 3. Fuel flows are to be used for flight planning only and will vary from airplane to airplane. Lean using the EGT.

Section V
Performance

BEECHCRAFT
Bonanza A36

CRUISE SPEEDS

30°C ICAO
OF PEAK EGT

ASSOCIATED CONDITIONS:

AVERAGE CRUISE WT 3400 LBS
TEMPERATURE STD DAY (ISA)

EXAMPLE

CRUISE ALTITUDE 11,000 FT
POWER SETTING FULL THROTTLE, 2500 RPM
TRUE AIRSPEED 168 KTS

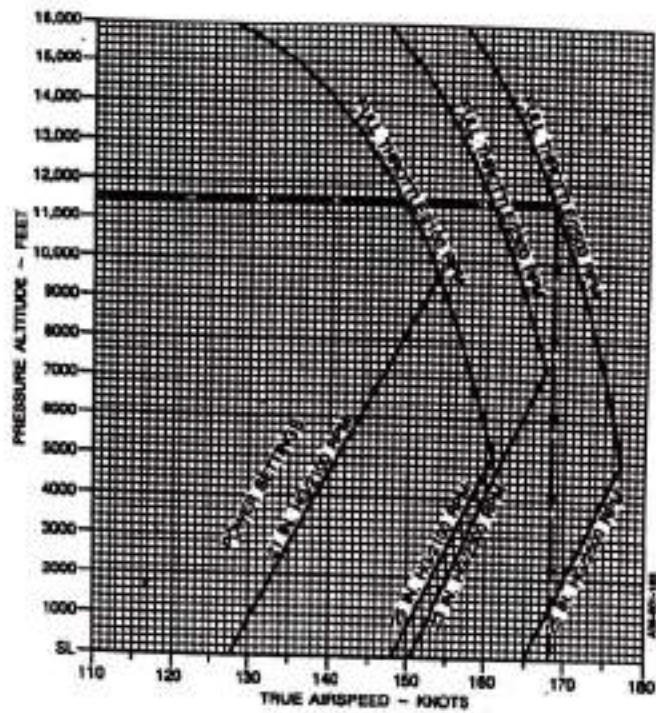

BEECHCRAFT
Bonanza A36

Section V
Performance

CRUISE SPEEDS

30°C ICAO
OF PEAK EGT

ASSOCIATED CONDITIONS:

AVERAGE CRUISE WT 3400 LBS
TEMPERATURE STD DAY (ISA)

EXAMPLE

CRUISE ALTITUDE 11,000 FT
POWER SETTING FULL THROTTLE, 2500 RPM
TRUE AIRSPEED 160 KTS

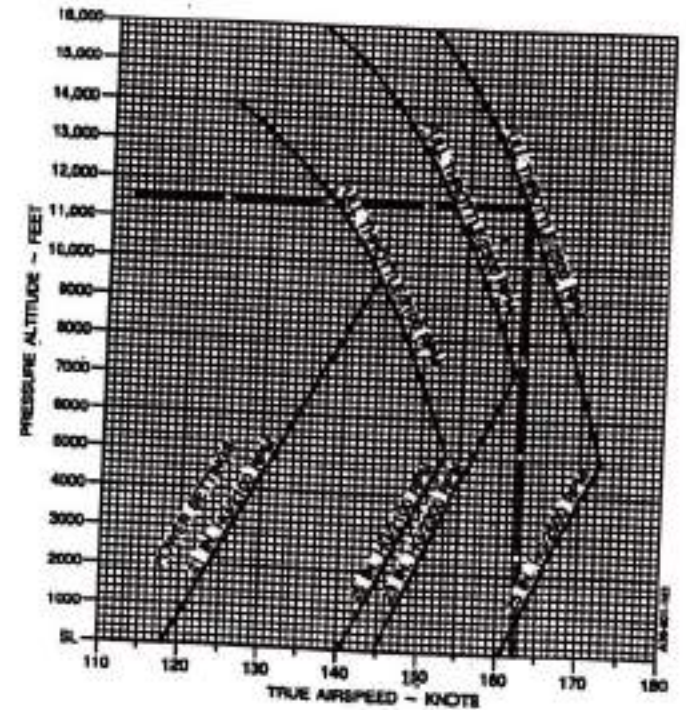

Section V
Performance

BEECHCRAFT
Bonanza A36

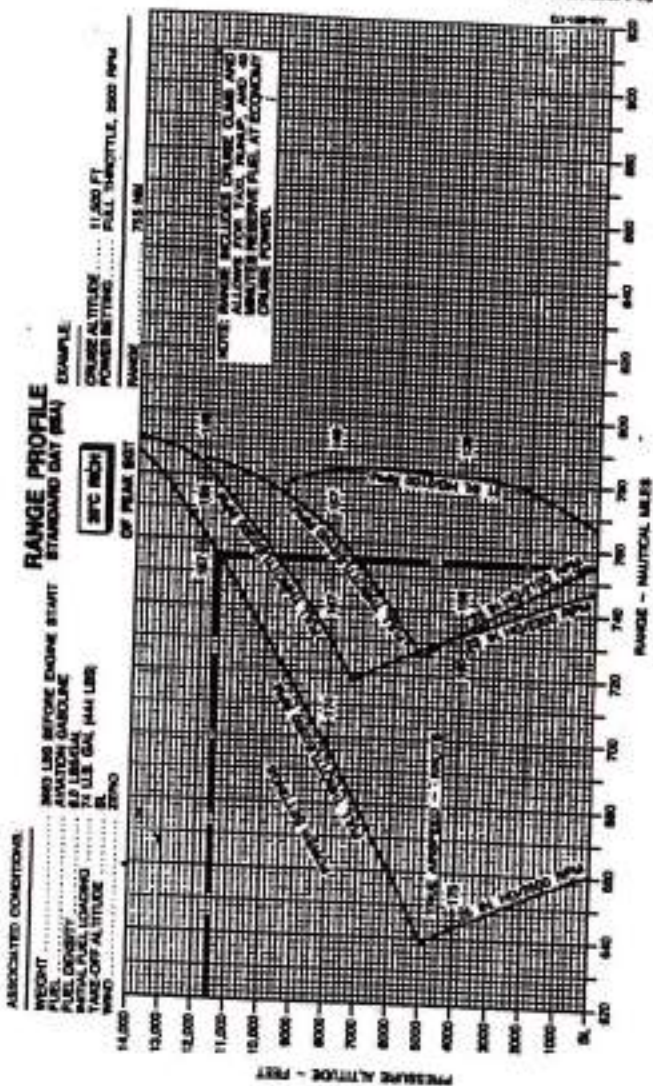

BEECHCRAFT
Bonanza A36

Section V
Performance

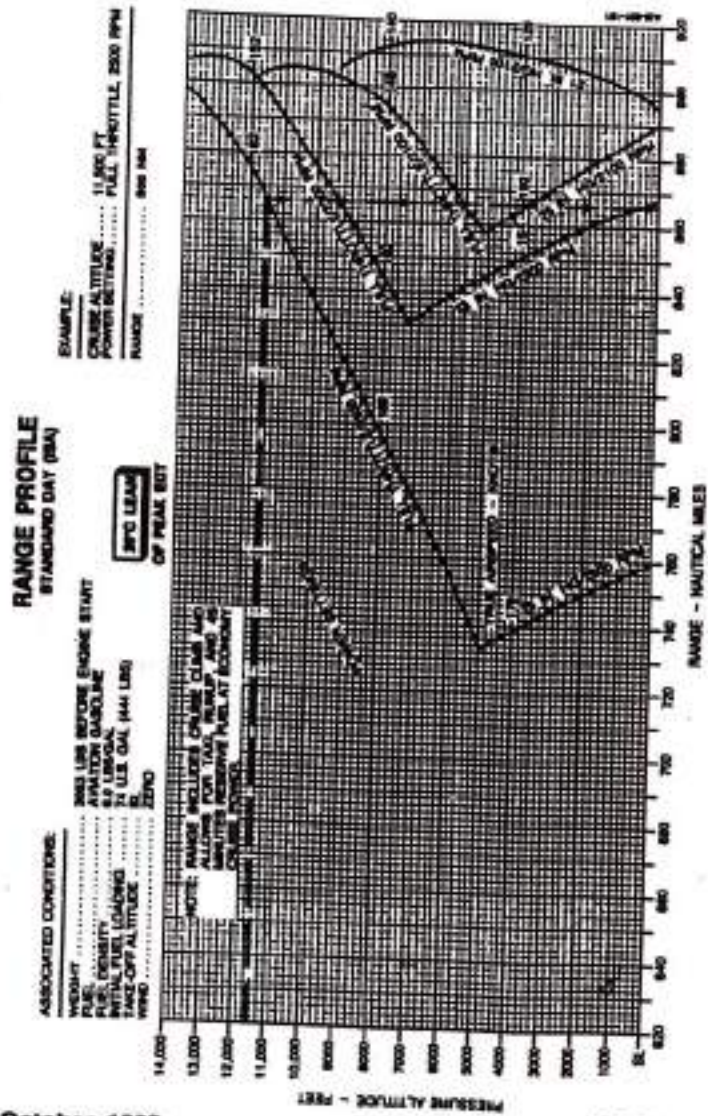

Section V
Performance

BEECHCRAFT
Bonanza A36

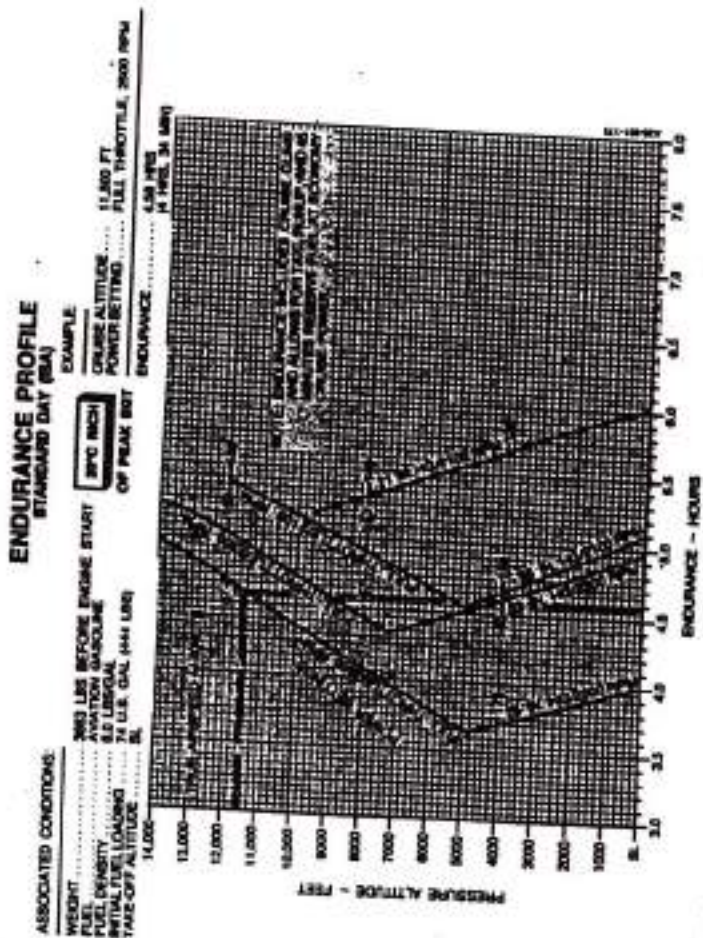

BEECHCRAFT
Bonanza A36

Section V
Performance

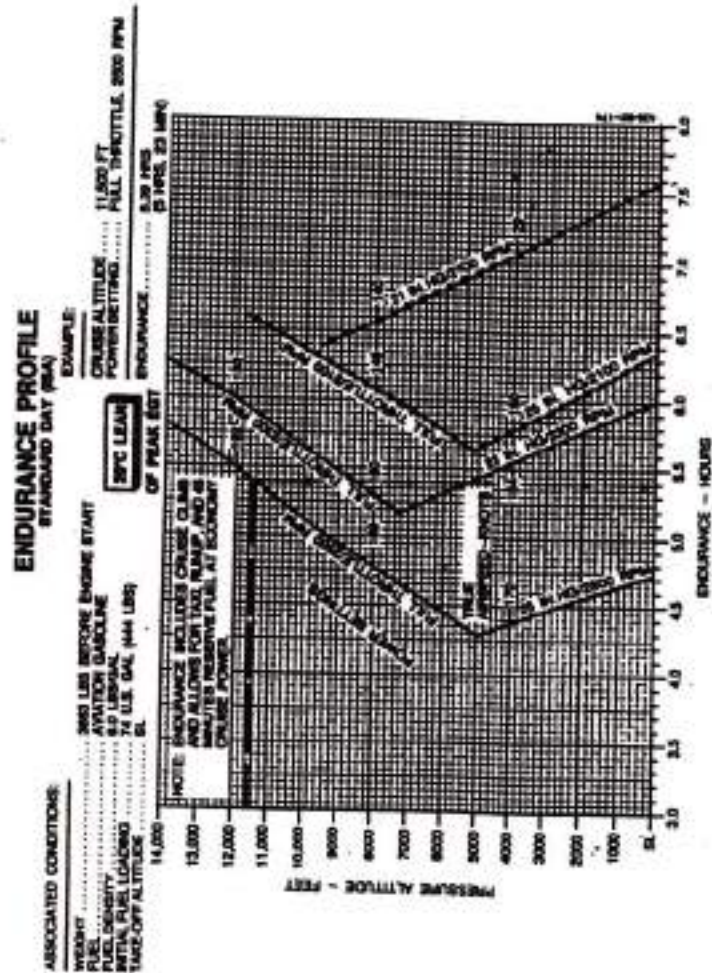

Section V
Performance

BEECHCRAFT
Bonanza A36

LANDING DISTANCE

ASSOCIATED CONDITIONS:
POWER..... RETARDED TO MAINTAIN 800 FT/MIN
FLAPS..... ON FINAL APPROACH
LANDING GEAR..... DOWN (ASBESTY)
RUNWAY..... DRY
APPROACH SPEED..... PAVED, LEVEL, DRY SURFACE
BRAKING..... AS TABULATED
MAXIMUM

WEIGHT - POUNDS	SPEED AT 80 FT - KNOTS
3000	78
3400	80
3800	81
4200	82

EXAMPLE:
DENSITY ALTITUDE..... 2575 FT
PRESSURE ALTITUDE..... 2965 FT
WEIGHT..... 3475 LBS
HEADWIND COMPONENT..... 10 KTS
GRASSING ROLL
TOTAL OVER 80 FT OBSTACLE..... 850 FT
TOTAL OVER 50 FT OBSTACLE..... 615 FT
APPROACH SPEED..... 82 KTS

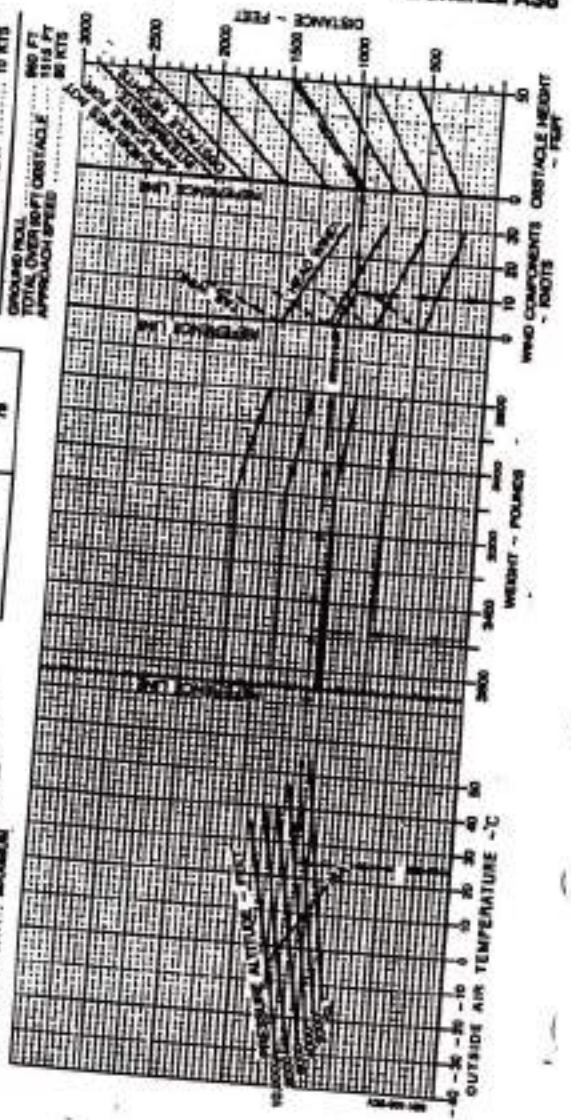

EDGEFIELD AVIATION, INC.
 Lake in the Hills Airport
 8399 Pyott Rd.
 Lake in the Hills, IL 60156
 Phone: (815) 439-4858
 Fax: (815) 439-6946

Date: 5-16-05

ACTUAL WEIGHT AND BALANCE REPORT

Aircraft Reg'd: Model # E11A, Serial # CE-432, N# 1074W
 Owner/Operator: Address: 26440 Fallbrook Circle, Barrington, IL 60010
 Previous Wt & Bal Date: 7-17-02 Empty Weight: 2247.01 C.G.: 81.45
 Useful Load: 1362.99 Moment: 18187.03

WEIGHT AND BALANCE COMPUTATION

Item	Weight	Arm	Moment
Left Main	1125	94	105650
Right Main	1125	94	105650
Nose	130	11.1	1443.0
Removed Usable Fuel	444	74	32856
New Weight and Balance	2350	81.31	19150
New E.W.	2250		
New C.G.	81.31		
New Moment	19150		
New Useful Load	1244		
Aircraft Gross Weight	3600		

Signature: *[Handwritten Signature]* ID: 183481286

12/14/05 - JA -

EW - 2244.06 81.31 182464.5
 Useful Load 1355.94

BEECHCRAFT Bonanza F33A
CE-290 thru CE-673

Section VI
Wt and Bal/Equip List

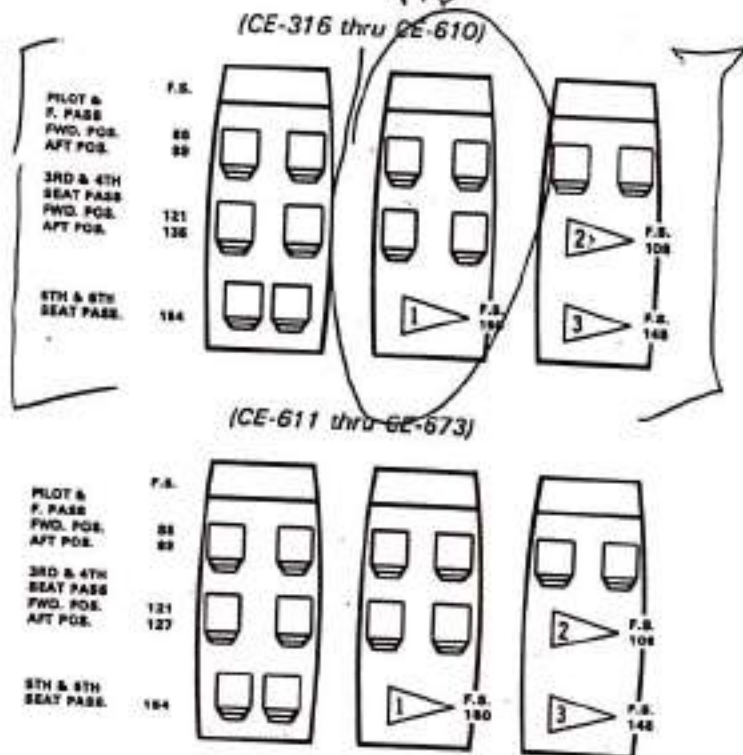

1. MAXIMUM WEIGHT 270 POUNDS INCLUDING EQUIPMENT AND BAGGAGE WITH 5th and 6th SEATS REMOVED OR STOWED.
2. MAXIMUM WEIGHT 200 POUNDS FORWARD OF REAR SPAR INCLUDING EQUIPMENT AND CARGO WITH 3rd and 4th SEATS REMOVED.
3. MAXIMUM WEIGHT 270 POUNDS AFT OF REAR SPAR INCLUDING EQUIPMENT AND CARGO WITH 3rd, 4th, 5th and 6th SEATS REMOVED.

November 1977

6-11

Section VI
Wt and Bal/Equip List

BEECHCRAFT Bonanza F33A
CE-290 thru CE-673

WEIGHT AND BALANCE LOADING FORM

(UTILITY OR NORMAL CATEGORY)

BONANZA F33A DATE

SERIAL NO. CE 432 REG NO. NXXX

ITEM	WEIGHT	MOM/100
1. BASIC EMPTY CONDITION		
2. FRONT SEAT OCCUPANTS		
3. 3rd and 4th SEAT OCCUPANTS		
4. 5th and 6th SEAT OCCUPANTS		
5. BAGGAGE		
6. CARGO		
7. SUB TOTAL ZERO FUEL CONDITION		
8. FUEL LOADING		
9. SUB TOTAL RAMP CONDITION		
10. *LESS FUEL FOR START, TAXI, AND TAKE-OFF		
11. SUB TOTAL TAKE-OFF CONDITION		
12. LESS FUEL TO DESTINATION		
13. LANDING CONDITION		

*Fuel for start, taxi and take-off is normally 12 lbs at an average mom/100 of 9.

6-16

November 1977

Section VI
Wt and Bal/Equip List

BEECHCRAFT Bonanza F33A
CE-290 thru CE-673

MOMENT LIMITS VS WEIGHT

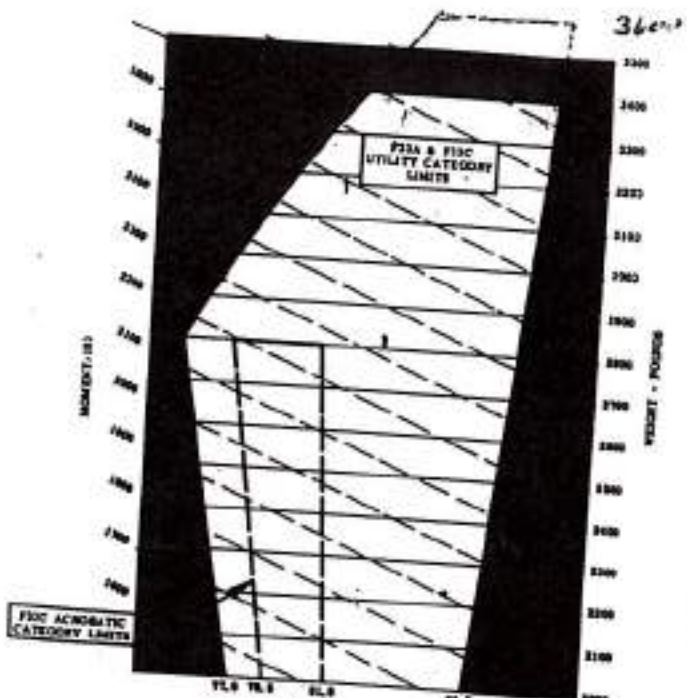

CENTER OF GRAVITY - 36 INCH AFT OF DATUM
ENVELOPE BASED ON THE FOLLOWING WEIGHT AND
CENTER OF GRAVITY LIMIT DATA (LANDING GEAR DOWN)

WEIGHT CONDITION	DOWNING C.G. LIMIT	AFT C.G. LIMIT
F33A & F33C UTILITY CATEGORY 3400 LB. MAXIMUM TAKE-OFF OR LANDING 300 LB. OR LESS	SL.1 TL.9	SL.1 SL.1
F33C ACROBATIC CATEGORY 3800 LB. OR LESS	SL.1 TL.9	SL.1 SL.9

CE-432 * USEFUL LOAD WEIGHTS AND MOMENTS
OCCUPANTS (CE-316 thru CE-610)

WEIGHT	Front Seats		Rear Seats (3rd and 4th)		Fifth and Sixth Seats
	Position	MOM/100	Position	MOM/100	
120	ARM 85	102	ARM 121	145	ARM 154
130		110	ARM 135	162	
140		119		176	
150		128		189	
160		136		202	
170		144		216	
180		153		230	
190		162		243	
200		170		256	
				270	

NOTE: OCCUPANT POSITIONS SHOWN ARE FOR THE SEATS ADJUSTED THE MAXIMUM RANGE. INTERMEDIATE POSITIONS WILL REQUIRE INTERPOLATION OF THE MOMENT/100 VALUES.

BEECHCRAFT Bonanza F33A
 CE-290 thru CE-673

Section VI
 Wt and Bal/Equip List

USEFUL LOAD WEIGHTS AND MOMENTS

(CE-316 thru CE-673) ✕ CE 432

BAGGAGE CARGO

ARM 150		Fwd of Spar (3rd and 4th Seats Removed)	Aft of Spar (3rd, 4th 5th and 6th Seats Removed)
		ARM 108	ARM 145
Weight	Mom/100	Mom/100	Mom/100
10	15	11	15
20	30	22	29
30	45	32	44
40	60	43	58
50	75	54	73
60	90	65	87
70	105	76	102
80	120	86	116
90	135	97	131
100	150	108	145
110	165	119	160
120	180	130	174
130	195	140	189
140	210	151	203
150	225	162	218
160	240	173	232
170	255	184	247
180	270	194	261
190	285	205	276
200	300	216	290
210	315		305
220	330		319
230	345		334
240	360		348
250	375*		363
260	390		377
270	405		392

USEFUL LOAD WEIGHTS AND MOMENTS

USABLE FUEL

LEADING EDGE TANKS ARM 75		
Gallons	Weight	Moment 100
5	30	23
10	60	45
15	90	68
20	120	90
25	150	113
30	180	135
35	210	158
40	240	180
44	264	198
50	300	225
55	330	248
60	360	270
65	390	293
70	420	315
74	444	333

*OIL

Quarts	Weight	Moment 100
12	23	6

*Included in Basic Empty Weight

RUDDER PEDALS

To adjust the rudder pedals, press the spring-loaded lever on each pedal arm and move the pedal forward or aft. The adjustment lever can also be used to place the right set of rudder pedals against the floor when not in use.

TRIM CONTROLS

Elevator trim is controlled by a handwheel located to the left of the throttle. An elevator tab indicator dial is located above and to the left of the trim control handwheel.

The aileron trimmer on the control column hub displaces the ailerons; displacement is maintained by cable loads imposed by the trimmer.

ELECTRIC ELEVATOR TRIM

The optional electric elevator trim system controls include the ON-OFF switch located on the instrument panel, a thumb switch on the control wheel and a circuit breaker on the right subpanel. The ON-OFF switch must be in the ON position to operate the system. The thumb switch is moved forward for nose down, aft for nose up, and when released returns to the center OFF position. When the system is not being electrically actuated, the manual trim control wheel may be used.

INSTRUMENT PANEL

The standard instrument panel of the Bonanza F33A consists of the floating instrument panel on the upper left portion, the engine instruments on a surrounding fixed panel, a radio grouping to the right of the engine instruments, and a subpanel which provides for a compact circuit breaker group on the right side and switching panel on the left.

FLIGHT INSTRUMENTS

The floating instrument panel contains all flight instruments except the magnetic compass. On this panel are the airspeed indicator, gyro horizon, altimeter, turn coordinator, directional gyro, and vertical speed indicator, with provisions for an ADF indicator and a clock. Additional navigation equipment, such as dual omni indicators, can be mounted in the panel directly below the flight instrument grouping.

POWER PLANT INSTRUMENTS

The engine instruments include: cylinder head temperature, oil temperature, oil pressure indicators, tachometer, manifold pressure, fuel flow, and fuel quantity indicators, and an ammeter.

The cylinder head temperature sensor is installed in the engine cylinder which, because of location in the compartment, has the highest temperature reading. Monitor cylinder head temperature after power setting adjustments are made, to assure that the engine operating temperature remains in the desired range.

The oil pressure normal operating range is 30 to 60 psi. The oil pressure should be checked when starting the engine and with extra attention when starting during cold weather. The oil temperature operating range is 100°F to 240°F. Monitor the oil temperature after starting to assure temperature is above minimum before advancing the throttle above warm-up rpm and on descent with power reduced to avoid overcooling.

The tachometer is driven by a flexible shaft from the engine accessory section. Incorporated in the tachometer is an engine hour meter which automatically records the total engine operating time.

Section VII
Systems Description

BEECHCRAFT Bonanza F33A
CE-290 thru CE-673

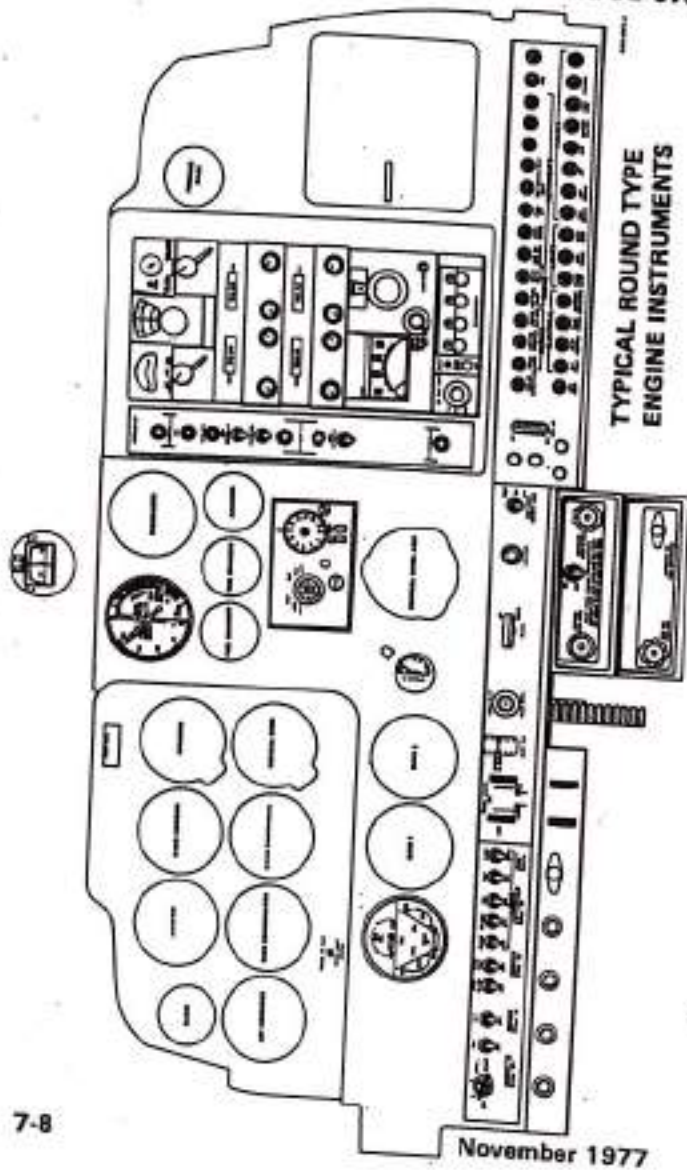

BEECHCRAFT Bonanza F33A
CE-290 thru CE-673

Section VII
Systems Description

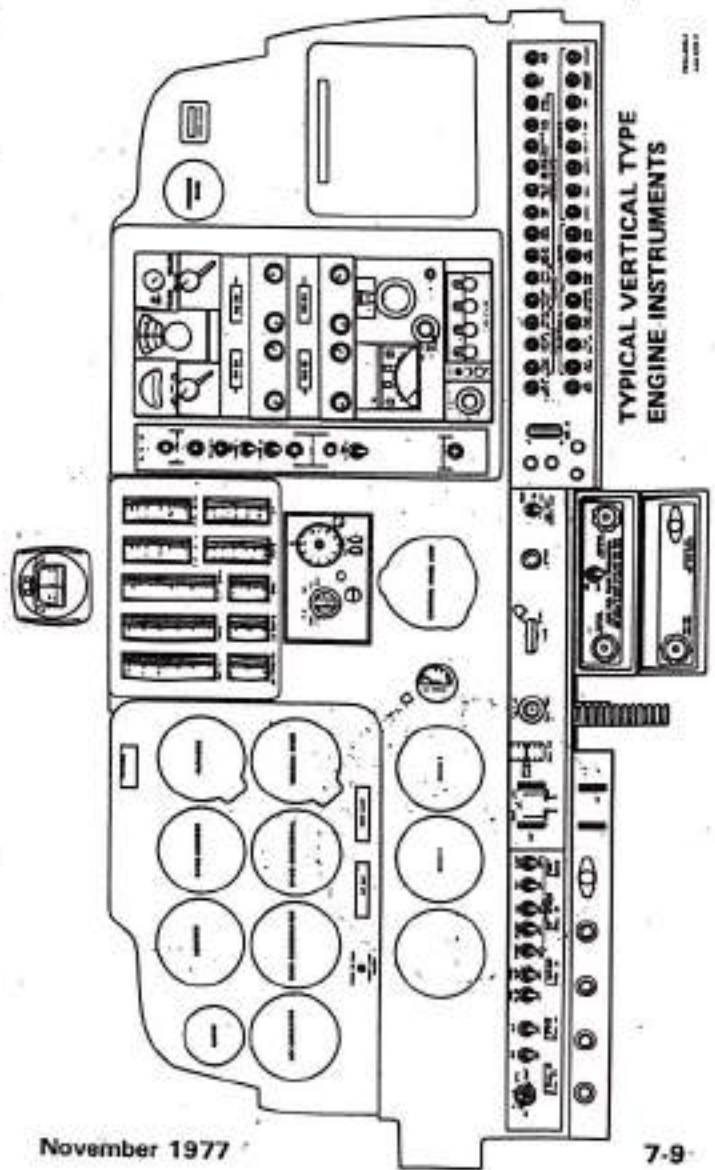

MANIFOLD PRESSURE AND FUEL FLOW INDICATOR
(Round Type)

The manifold pressure portion of this instrument indicates the pressure of the fuel-air mixture entering the engine cylinders and is calibrated in inches of mercury. By observing the manifold pressure indications and adjusting the propeller and throttle controls, the power output of the engine can be regulated. To avoid excessive cylinder pressures during cruise operations, observe the maximum recommended rpm and manifold pressure as indicated on the Manifold Pressure vs RPM graph in the PERFORMANCE Section.

The fuel flow portion of the indicator is calibrated in gallons per hour, the green arc indicating fuel flow for normal operating limits. Red radials are placed at the minimum and maximum allowable fuel pressures.

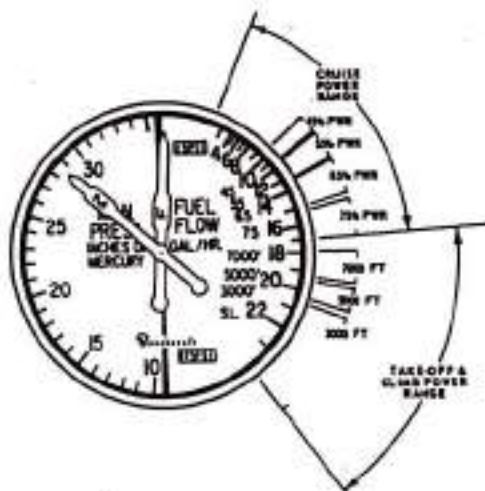

In the cruise power range, the green sectors cover the fuel flow required from 45% to 75% power. The lowest value of a given sector is the cruise-lean setting, and the highest value of the sector is the best-power setting for that particular power range.

The take-off and climb range is covered by green sectors for full power at various altitudes. The high side of each green sector represents the fuel flow setting required to achieve maximum power at the specified altitude when operating full throttle at 2700 rpm. These values should correspond to the fuel flow values on the Climb graph in the PERFORMANCE Section.

MULTIPLE READOUT TYPE INSTRUMENT (Round Type)

A multiple readout type instrument, on early aircraft with round type instruments, is located on the lower left instrument panel and gives indications of cylinder head temperature calibrated in degrees Fahrenheit, oil temperature and oil pressure.

ELECTRICALLY OPERATED VERTICAL INSTRUMENTS

Electrically operated vertical readout instruments are installed in the upper center of the instrument panel. They include manifold pressure, tachometer, fuel flow meter calibrated in pounds per hour, cylinder head temperature and oil temperature indicator both calibrated in degrees centigrade, oil pressure indicator, ammeter, and left and right fuel quantity indicators calibrated in pounds.

FUEL FLOW INDICATOR (Vertical Type)

The fuel flow indicator is calibrated in pounds per hour. The normal operating range of 41.4 pph to 145.8 pph is

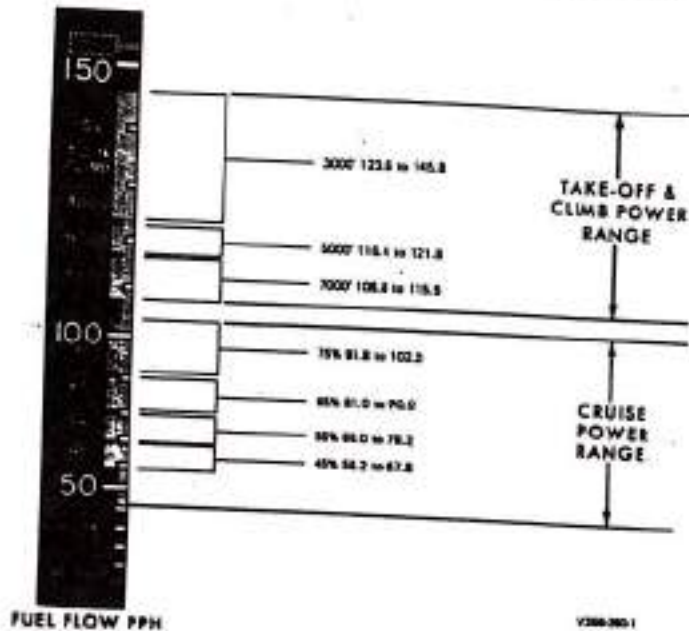

indicated on the instrument by the green band. Red markings indicate the minimum and maximum fuel pressure. In the illustration the lower portion of the scale (58.2 pph to 102.0 pph) is the fuel flow required for cruise power settings between 45% and 75%. The upper portion indicates fuel flow for take-off and climb at various altitudes. The lower fuel flow figure is the normal lean setting while the higher flow is the best power setting for that percentage of power. The high side of each green sector represents the fuel flow setting required to achieve maximum power of the specified altitude when operating full throttle at 2700 rpm. These values should correspond to the fuel flow values on the Climb graph in the PERFORMANCE section.

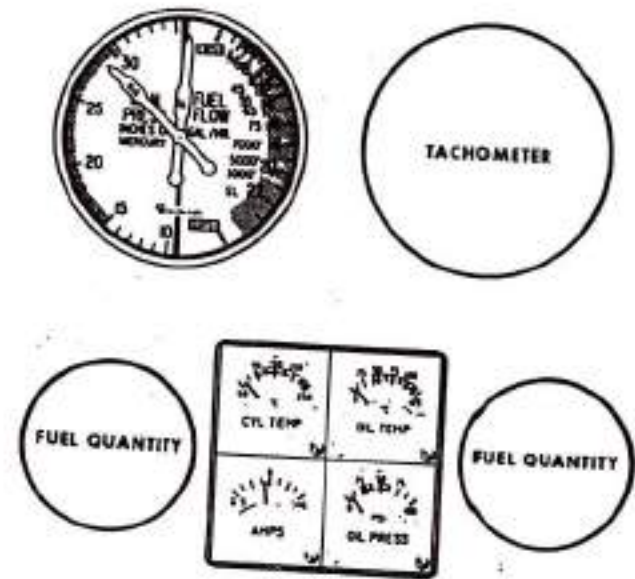

CLUSTER ARRANGEMENT

CLUSTER TYPE POWER PLANT INSTRUMENTS

The cluster type instruments, as shown in accompanying illustration, are located in the center of the panel just below the manifold pressure, fuel flow and tachometer. Included in the square cluster are the cylinder head temperature and oil temperature, both calibrated in degrees Centigrade, ammeter, and oil pressure. A fuel quantity indicator is located on each side of the cluster, the left indicator for the left wing fuel and the right indicator for the right wing fuel.

AVIONICS PANEL

Tuning and selecting equipment for the radios, to the right of the center panel, is mounted in block form with switching on the left edge of the block and radio heads and tuning on the right.

SWITCHES

The magnetostart switch and switches for the battery, alternator, pitot heat, propeller deicer, and lights are located on the left end of the subpanel. Flap and tab position indicators and the flap switch are near the center of the subpanel. On the right end of the subpanel are the circuit breakers, as well as the landing gear switch and landing gear position indicator lights. Attached to the lower center section of the subpanel are the powerplant controls and auxiliary fuel pump switch.

ANNUNCIATOR SYSTEM

WARNING LIGHT

A warning light placarded ALT OUT is located on the pilot's floating instrument panel. It will illuminate if an alternator malfunction occurs.

WARNING LIGHT CONTROL SWITCH

Located on the pilot's floating instrument panel near the ALT OUT warning light is a switch placarded PRESS TO TEST - WARN LAMP SYSTEM. When the switch is pressed, the ALT OUT light and the landing gear position indicator lights will illuminate if none of the lamps require replacement.

GROUND CONTROL

Steering is accomplished by use of the rudder pedals through a linkage arrangement which connects the nose strut to the rudder pedal shaft. Nose wheel straightening is accomplished by engagement of a roller with a track as the nose wheel is retracted. The steering link attaches to the steering mechanism on the nose strut with a swivel connection which permits the mechanism to disengage when the nose gear is retracted and operation of the rudder pedals will have no tendency to turn the nose wheel with the gear retracted.

The minimum wing tip turning radius, using full steering, one brake and partial power, is 28 feet 4 inches.

WING FLAPS

The wing flaps are controlled by a three-position switch, UP, OFF, and DOWN, located in the subpanel, above the power quadrant. The switch must be pulled out of detent before it can be repositioned. A dial type indicator has markings for UP, 10°, 20°, and DN. The indicator is located to the left of the control column.

Limit switches automatically turn off the electric motor when the flaps reach the extremes of travel. Intermediate flap positions can be obtained by placing the switch in the OFF position as the flaps reach the desired position during flap extension or retraction.

LANDING GEAR SYSTEM

CAUTION

Never taxi with a flat strut.

The landing gears are operated through adjustable linkage connected to an actuator assembly mounted beneath the front seats. The actuator assembly is driven by an electric motor. The landing gears may be electrically retracted and extended, and in an emergency may be extended manually.

CONTROL SWITCH

The landing gear is controlled by a two-position switch on the right side of the subpanel. The switch handle must be pulled out of the safety detent before it can be moved to the opposite position.

POSITION INDICATORS

The landing gear position indicator lights are located adjacent to the landing gear switch handle. Three green lights, one for each gear, are illuminated whenever the landing gear are down and locked. The red light illuminates any time one or all of the landing gear are in transit or in any intermediate position. All of the lights will be out when the gear are up.

Testing of the landing gear position indicator lights is accomplished by pressing the warning light test button on the floating instrument panel. The intensity of the lamps is automatically lowered for night flights when the navigation lights are turned on.

SAFETY SWITCH

To prevent inadvertent retraction of the landing gear on the ground, a main strut safety switch opens the control circuit when the strut is compressed.

WARNING

Never rely on the safety switch to keep the gear down during taxi or on take-off, landing roll, or in a static position. Always make certain that the landing gear switch is in the down position during these operations.

CIRCUIT BREAKER

The landing gear circuit breaker is located on the right subpanel. This circuit breaker is a pull-and-reset type breaker. The breaker will pop out under overload conditions.

BRAKES

The brakes on the main landing gear wheels are operated by applying toe pressure to the rudder pedals.

CAUTION

Continuous brake application of either the pilot's or copilot's brake pedals in conjunction with an overriding pumping action from the opposite brake pedals could result in the loss of braking action on the side which continuous pressure is being applied.

The parking brake push-pull control is located on the left side of the lower subpanel. To set the parking brakes, pull control out and depress both toe pedals until firm. Push the control in to release the brakes.

Continued next page. ■

CAUTION

The parking brake should be left off and wheel chocks installed if the airplane is to be left unattended. Changes in ambient temperature can cause the brakes to release or to exert excessive pressures.

MANUAL EXTENSION

The landing gear can be manually extended by operating a handcrank at the rear of the front seats. This procedure is described in the EMERGENCY PROCEDURES section.

WARNING HORN

With the landing gear retracted, if the throttle is retarded below approximately 12 in. Hg manifold pressure, a warning horn will sound intermittently.

BAGGAGE COMPARTMENT

The baggage compartment is accessible through the baggage door on the right side of the fuselage. This area extends aft of the pilot and copilot seats to the rear bulkhead. Because of structural limitations, this area is divided into two sections, each having a different weight limitation. Loading within the baggage compartment must be in accordance with the data in the WEIGHT AND BALANCE Section. All baggage must be secured.

WARNING

Do not carry hazardous material anywhere in the airplane.

Do not carry children in the baggage compartment unless secured in a seat.

SEATS, SEAT BELTS, AND SHOULDER HARNESSSES

SEAT ADJUSTMENTS

To adjust any of the four standard seats forward or aft, pull up on the release bar below the seat and slide the seat to the desired position. The seat backs of all standard seats can be placed in any of four positions by operating a release lever on the inboard side of each seat. An option is available that provides for the seat backs on the copilot, 3rd and 4th place seats to be placed in any position from vertical to fully reclined.

Outboard armrests for all standard seats are built into the cabin sidewalls. Center armrests can be elevated or positioned flush with the seat cushions. On CE-634 and after, the 3rd- and 4th-place chairs are equipped with a locking back to accommodate the shoulder harness, and the seat back can be folded over for access by rotating the red handle located on the lower inboard side of the seat back. The optional fifth and sixth seats can be folded up to provide additional floor space.

SHOULDER HARNESS INSTALLATION (Prior to CE-634)

The shoulder harness installation is available for the pilot seats only. The belt is in the "Y" configuration with the single strap being contained in an inertia reel attached to the overhead canopy structure of the cockpit. The two straps are worn with one strap over each shoulder and fastened by metal loops into the seat belt buckle. The harness should be used with the seats in the upright position. The spring loading at the inertia reel keeps the harness snug but will allow normal movement required during flight operations. The inertia reel is designed with a locking device that will secure the harness in the event of sudden forward movement or an impact action.

Section VII
Systems Description

BEECHCRAFT Bonanza F33A
CE-290 thru CE-673

SHOULDER HARNESS INSTALLATION
(CE-634 thru CE-673)

The shoulder harness is a standard installation for all seats and should be used with the seats in the upright position. The spring loading at the inertia reel keeps the harness snug but will allow normal movement during flight operations. The inertia reel is designed with a locking device that will secure the harness in the event of sudden forward movement or an impact action.

The strap is worn over the shoulder and down across the body, where it is fastened by a metal loop into the seat belt buckle. For the pilot seats, the harness strap is contained in an inertia reel attached to the side canopy structure of the cockpit. The inertia reel is covered with an escutcheon and the strap runs up from the reel location to a looped fitting attached to the window frame just aft of the pilot seats. For the third and fourth passenger seats, the inertia reel is attached into the seat back structure and is covered with the seat back upholstery. The strap runs up the seat back and over the outboard corner of the seat back. For the fifth and sixth passenger seats, the strap is contained in an inertia reel attached to the upper fuselage side structure, just aft of the seat back and is covered with an escutcheon.

NOTE

The seat belt is independent of the shoulder harness, but the outboard seat belt and the shoulder harness must be connected for stowage when the seat is not occupied.

7-20

November 1977

BEECHCRAFT Bonanza F33A
CE-290 thru CE-673

Section VII
Systems Description

DOORS, WINDOWS AND EXITS

CABIN DOOR

The outside cabin door handle is spring loaded to fit into a recess in the door to create a flat aerodynamically clean surface. To open the door from the outside, lift the handle from its recess and pull until the door opens.

To close the cabin door from the inside, observe that the door handle is in the unlocked position. In this position, the latch handle is free to move approximately one inch in either direction before engagement of the locking mechanism. Then grasp the door and firmly pull the door closed. Rotate the door handle fully counterclockwise into the locked position. When the door is properly locked, the door latch handle is free to move approximately one inch in either direction.

NOTE

When checking the door latch handle, do not move it far enough to engage the door latch release mechanism.

Press firmly outward at the top rear corner of the door. If any movement of the door is detected, completely open the door and close again following the above instructions.

To open the door from the inside, depress the lock button and rotate the handle clockwise.

OPENABLE CABIN WINDOWS

To Open Window For Ventilation (Only On Ground):

Release latch front of bar, pull bar at the bottom of the window out and upward. Window will open approximately two inches.

Revised: March 1983

7-21

Section VII
Systems Description

BEECHCRAFT Bonanza F33A
CE-290 thru CE-673

To Close Window:

Pull inward and down on the bar at the bottom of the window. Resistance will be felt as the bar moves downward. Continue moving bar downward to its lowest position. Check that bar is locked by the latch.

NOTE

Window is to be closed before and during flight. While closing window, ascertain that the emergency release pin (which allows the window to open fully for emergency exit) is securely in place.

EMERGENCY EXITS

To open the emergency exit provided by the openable middle window on each side of the cabin:

1. Lift the latch.
2. Pull out the emergency release pin and push the window out.

The above procedure is described on a placard installed below the left and right middle windows.

CONTROL COLUMN LOCK PIN

1. Rotate control wheel and move column so the hole in the bracket and the column align to accept pin.
2. Push the control column lock pin through the hole provided in the control column hanger and into the hole in the control column tube assembly.
3. Ensure positive retention of the lock pin by positioning the attached red plate on top of the throttle and propeller controls.

WARNING

Before starting engine, remove the lock reversing the above procedure.

7-22

Revised: March 1983

BEECHCRAFT Bonanza F33A
CE-290 thru CE-673

Section VII
Systems Description

POWER PLANT

One Teledyne Continental Motors Corporation engine model IO-520-B, IO-520-BA or IO-520-BB. It is a fuel-injected, direct-drive, air-cooled, horizontally-opposed, 6-cylinder, 520-cubic inch-displacement, 285-horsepower-rated engine.

ENGINE CONTROLS

THROTTLE, PROPELLER, AND MIXTURE

The push-pull throttle, propeller and mixture controls are located on the control console. Each control is released for repositioning by pushing a button on the knob. With the button extended, fine adjustments are accomplished by rotating the knob, clockwise to increase and counter-clockwise to decrease. Do not rotate clockwise with control fully advanced.

COWLING

The Bonanza is equipped with Hartwell latch mechanisms on the right and left upper engine cowling for quick and easy access to the engine compartments without the aid of tools. Each cowl latch is locked and released by a single recessed handle located in the lower cowling panel on each side of the engine. To close the cowling requires only to lower the cowling to the closed position with the handle in the prelatch position. The handle has three positions: flush with the fuselage - latched; held fully forward - unlatched (open cowling); approximately 90° to the fuselage - prelatch (ready to close cowl). An audible click denotes the bayonet fittings, located forward and aft on the upper cowl, sliding into the latch safety catch. The cowl is locked by moving the latch handle to the full recessed position. The security of the forward latches can be checked by pulling out on the check tab attached to the lower forward edge of the upper cowling. If the cowling can be moved after latching, open the cowling, check the latch alignment and re-latch.

Revised: March 1983

7-23

Section VII
Systems Description

BEECHCRAFT Bonanza F33A
CE-290 thru CE-673

COWL FLAPS

The push-pull cowl flap control is located above and to the left of the control console on the subpanel. Except in extremely low temperatures, the cowl flaps should be open during ground operation, take-off, and as required in flight.

INDUCTION SYSTEM ICING

The possibility of induction system icing is reduced by the non-icing characteristics of the Bonanza's fuel injected engine and the automatic alternate air source. Under certain conditions, however, impact ice can form at several points in the induction system. If the air intake or filter becomes clogged with ice, a spring-loaded door in the air intake duct will open automatically and the induction system will operate on alternate air. If the alternate air source door becomes frozen in the closed position, a pull-and-release T-handle is provided to force the door open.

LUBRICATION SYSTEM

The engine oil system is the full pressure, wet sump type and has a 12-quart capacity. Oil operating temperatures are controlled by an automatic thermostat bypass control. The bypass control will limit oil flow through the oil cooler when operating temperatures are below normal and will permit the oil to bypass the cooler if it should become blocked.

STARTER

The starter is relay-controlled and is actuated by a rotary type, momentary-on switch incorporated in the magneto/start switch. To energize the starter circuit, rotate the magneto/start switch beyond the BOTH position to START. After starting, release the switch to the BOTH position.

7-24

November 1977

BEECHCRAFT Bonanza F33A
CE-290 thru CE-673

Section VII
Systems Description

PROPELLER

McCaughey constant speed, two blade propeller

Hub: 2A36C23

Blades: 84B-0

Diameter: Maximum 84 in., Minimum 82 in.

Pitch settings at 30 in. sta.:

Low - 13.3°

High - not under 29.2°

or

McCaughey constant speed, three bladed propeller

Hub: 3A32C76

Blades: 82NB-2

Diameter: Maximum 80 in., Minimum 78.5 in.

Pitch settings at 30 in. sta.:

Low - 13.3° ± 0.2°

High - not under 29.0° ± 0.5°

or

Hartzell constant speed, three blade propeller

Hub: Hartzell PHC-A3VF-4

Blades: V8433-2R or V8433-4R

Diameter: Maximum 82 in., Minimum 78-1/4 in.

Pitch settings at 30 in. sta.:

Low - 10.5° for V8433-2R

- 11.2° for V8433-4R

High - 30.8° for both

Propeller rpm is controlled by a governor which regulates hydraulic oil pressure to the blades. A push-pull knob on the control console allows the pilot to select the governor's rpm range.

November 1977

7-25

Section VII
Systems Description

BEECHCRAFT Bonanza F33A
CE-290 thru CE-673

If governor oil pressure is lost, the propeller will go to the full high rpm position. This is because propeller low rpm is obtained by governor boosted engine oil pressure working against the centrifugal twisting moment of the blades.

FUEL SYSTEM

The airplane is designed for operation on grade 100LL (blue) or 100 (green) aviation gasoline.

CAUTION

Before refueling, make certain the airplane and fuel dispensing unit are properly grounded. Failure to do so creates a fire hazard.

FUEL CELLS

Either the 44-gallon usable (50-gallon capacity) standard fuel system or the 74-gallon usable (80-gallon capacity) optional fuel system is available. The fuel system consists of a rubber fuel cell in each wing leading edge with a flush type filler cap. A visual measuring tab is attached to the filler neck of the optional system. The bottom of the tab indicates 27 gallons of usable fuel and the detent on the tab indicates 32 gallons of usable fuel in the tank provided the wings are level.

The engine driven fuel injector pump delivers approximately 10 gallons of excess fuel per hour, which bypasses the fuel control and returns to the tank being used. Three fuel drains are provided, one in each fuel sump on the underside of each wing and one in the fuel selector valve inboard of the left wing root. These points should be drained daily before the first flight.

BEECHCRAFT Bonanza F33A
CE-290 thru CE-673

Section VII
Systems Description

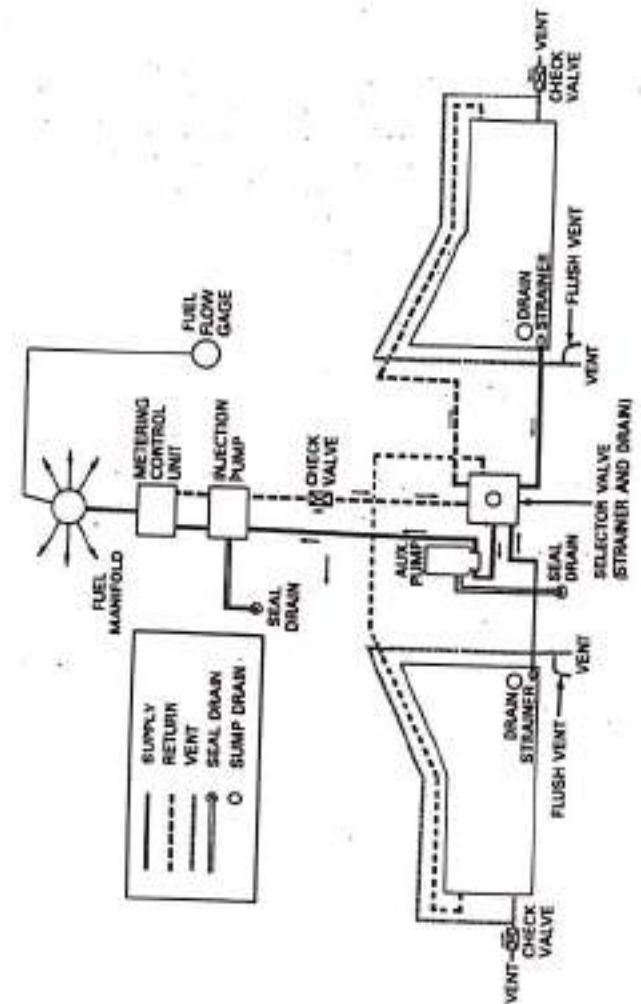

FUEL SYSTEM SCHEMATIC

FUEL QUANTITY INDICATION SYSTEM

Fuel quantity is measured by float operated sensors, located in each wing tank system. These transmit electrical signals to the individual indicators that indicate fuel remaining in the tank. There are sensors in each wing tank system connected to the individual wing tank indicator.

AUXILIARY FUEL PUMP

The electric auxiliary fuel pump is controlled by an ON-OFF toggle switch on the control console. It provides pressure for starting and emergency operation. Immediately after starting, the auxiliary fuel pump can be used to purge the system of vapor caused by an extremely high ambient temperature or a start with the engine hot. The auxiliary fuel pump provides for near maximum engine performance should the engine driven pump fail.

FUEL TANK SELECTION

The fuel selector valve handle is located forward and to the left of the pilot's seat. Take-offs and landings should be made using the tank that is more nearly full.

If the engine stops because of insufficient fuel, refer to the EMERGENCY PROCEDURES Section for the Air Start procedures.

FUEL REQUIRED FOR FLIGHT

It is the pilot's responsibility to ascertain that the fuel quantity indicators are functioning and maintaining a reasonable degree of accuracy, and be certain of ample fuel for a flight. Takeoff is prohibited if the fuel quantity indicators do not indicate above the yellow arc. An inaccurate indicator could give an erroneous indication of fuel quantity. A minimum of 13 gallons of fuel is required in each tank before takeoff.

The filler caps should be removed and fuel quantity checked to give the pilot an indication of fuel on board. The airplane must be approximately level for visual inspection of the tank. If the pilot is not sure that at least 13 gallons are in each tank, add necessary fuel so that the amount of fuel will be not less than 13 gallons per tank at takeoff. Plan for an ample margin of fuel for any flight.

ELECTRICAL SYSTEM

The system circuitry is the single-wire, ground-return type, in which the airplane structure itself is used as the ground return.

The battery ON-OFF switch, the alternator ON-OFF switch, and the magneto/start switch are located on the left sub-panel. The circuit breaker panel is located on the right sub-panel and contains circuit breakers for the various electrical systems. Some switch-type circuit breakers are located on the left subpanel.

BATTERY

A 35 ampere-hour, 12-volt battery is located on the right forward side of the firewall. Battery servicing procedures are described in the HANDLING, SERVICING AND MAINTENANCE section.

ALTERNATOR

A 70-amperes, 12-volt, gear-driven alternator is standard equipment. The alternator is designed to maintain approximately 70-ampere output at 1700 rpm, and supply approximately 20 amperes at engine idle speed.

A transistorized voltage regulator adjusts alternator output to the required electrical load, including battery recharging. Charge or discharge of the battery is indicated by the ammeter. A zero reading, which is normal for cruising flight, indicates that the battery is fully charged and that alternator output has been adjusted by the voltage regulator to balance the load of the electrical equipment in use.

The alternator field circuit breaker is located on the right sub-panel and the alternator output circuit breaker is installed on the left side of the nose wheel well cover. The alternator-out warning light can be tested by the warning test switch on the instrument panel adjacent to the light. If a malfunction occurs the light will illuminate.

Refer to the HANDLING, SERVICING AND MAINTENANCE Section for minor maintenance of the alternator.

EXTERNAL POWER RECEPTACLE

The external power receptacle accepts a standard AN type plug. Before connecting an external power unit turn battery switch and avionic equipment OFF.

CAUTION

A negative ground external power source is required. Check polarity before using external power.

If the external power unit does not have a standard AN type plug, connect the positive lead from the external power source to the positive battery terminal and the negative lead to the negative battery terminal.

LIGHTING SYSTEM

INTERIOR LIGHTING

Lighting for the instrument panel is controlled by thumb-rotated, disc-type rheostats, located on the pilot's sub-panel to the left of the control column. The first rheostat is labeled RADIO and ENG and controls the lighting of the avionics panel and the multiple readout engine instrument. The second rheostat labeled INST is optional and controls the lighting for the flight instruments, the omni indicators, and the instrument pressure gage.

On the lower subpanel are two more lighting rheostats, the first labeled SUB which controls the intensity of the complete subpanel lighting. The second rheostat is labeled FLOOD and controls the glare shield lighting which illuminates the full upper panel.

The cabin dome light is operated by an ON-OFF switch adjacent to the light. The optional reading lights above the rear seats have individual switches at the light. The optional map light has a press type switch on the wheel. The OAT, map, and compass lights are controlled by a PUSH-ON, PUSH-OFF switch located adjacent to the OAT or on the control wheel.

EXTERIOR LIGHTING

The switches for all of the exterior lights are located on the pilot's subpanel. Each switch is a circuit-breaker-type which will open the switch if it becomes overloaded or shorted.

The exterior lights consist of navigation lights on the wing tips and tail cone, a landing light in the fuselage nose section, and a taxi light attached to the nose strut. The landing light can be used for approach and taxiing. Use the landing light for approach and the taxi light for taxiing. For longer battery and lamp life, use the landing light and taxi light sparingly; avoid prolonged operation which could cause overheating during ground maneuvering.

NOTE

Particularly at night, reflections from anti-collision lights on clouds, dense haze or dust can produce optical illusions and intense vertigo. Such lights, when installed, should be turned off before entering an overcast; their use may not be advisable under instrument or limited VFR conditions.

ENVIRONMENTAL SYSTEMS

CABIN HEATING

A heater muffler on the right engine exhaust stack provides for heated air to five outlets in forward and aft areas of the cabin. Two forward outlets are located above and forward of each set of rudder pedals. One aft outlet is installed behind the right front seat and a second one under the right rear seat. The fifth outlet provides heated air for windshield defrosting.

Fresh ram air enters an intake on the right side of the nose, passes through the heater muffler, then into a mixer valve on the forward side of the firewall. In the mixer valve, the heated air is combined with a controlled quantity of unheated ram air picked up at an intake at the rear engine baffle. Air of the desired temperature is then ducted from the mixer valve to the outlets in the cabin.

HEATER AND DEFROSTER OPERATION

The heater controls are all located on the lower left subpanel. To provide heated air to the cabin outlets, pull the CABIN HEAT control. The control regulates the amount of cold air that is mixed with the air from the heater muff. When the control is pulled fully out, the cold air is shut off and only heated air enters the cabin. The forward vents, located on the firewall forward of the rudder pedals, deliver heated air to the forward cabin when the CABIN HEAT control is pulled out.

To deliver heated air to the aft seat outlets, pull the AFT CABIN HEAT control. For maximum heat, the control is pulled fully out. To obtain heated air for defrosting the windshield pull the DEFROST control out. It may be necessary to vary or close the AFT CABIN HEAT control to

Section VII
Systems Description

BEECHCRAFT Bonanza F33A
CE-290 thru CE-673

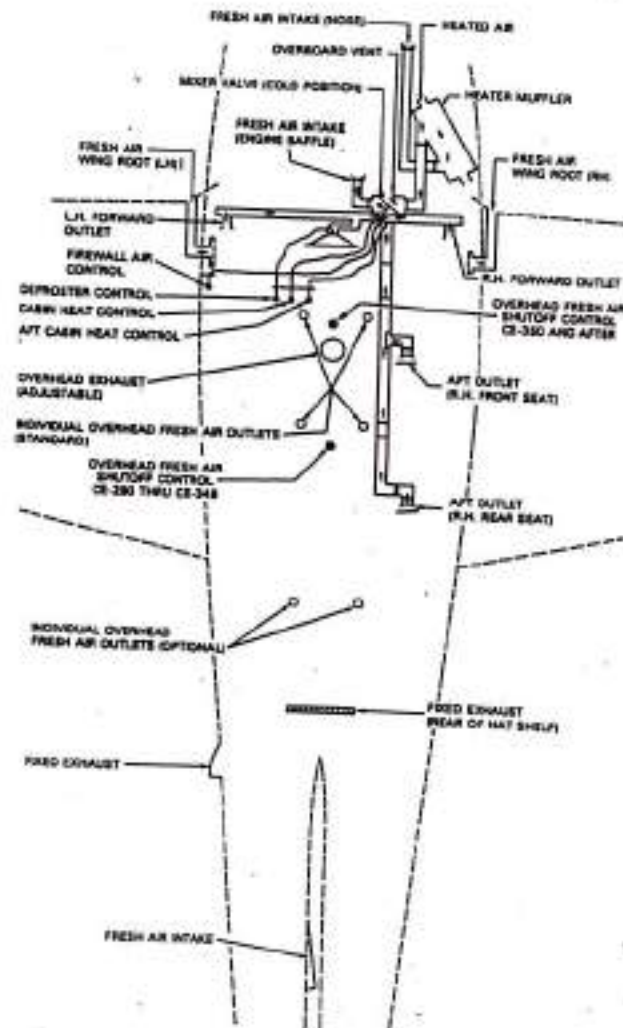

HEATING AND VENTILATION SYSTEM SCHEMATIC

7-34

November 1977

BEECHCRAFT Bonanza F33A
CE-290 thru CE-673

Section VII
Systems Description

obtain maximum air flow for defrosting. To close off all air from the heater system, pull the red FIREWALL AIR control located at the extreme left of the pilots' lower sub-panel.

CABIN VENTILATION

In moderate temperatures, ventilation air can be obtained from the same outlets used for heating, by pushing the CABIN HEAT control full forward. However, in extremely high temperatures, it may be desirable to pull the FIREWALL AIR control and use only the fresh air outlets described in the following paragraphs.

CABIN FRESH AIR OUTLETS

A duct in each wing root is connected directly to an adjustable outlet in the upholstery panel forward of each front seat. Airflow from the right outlet is controlled by a center knob. The volume of air from the left outlet is regulated by a center knob, and the direction of airflow is controlled by rotating the louvered cover with the small knob on the rim.

Individual Overhead Fresh Air Outlets

Fresh ram air from the air intake on the upper side of the aft fuselage is ducted to individual outlets above each seat. Each outlet can be positioned to direct the flow of air as desired. The volume of incoming air can be regulated by rotating the outlet. A system shutoff valve is installed in the duct between the overhead fresh air scoop and the individual fresh air outlets. The valve is operated by a push-pull control or by turning a knob in the overhead panel.

November 1977

7-35

EXHAUST VENTS

A manually controlled cabin air exhaust vent is located aft of the radio speaker in the overhead panel. In addition, a fixed exhaust is vented through the hat shelf.

OXYGEN SYSTEM

The oxygen cylinder is located beneath the cover under the front seats. The system is available with either four, five or six outlets and with either a 49 or 114 cu ft oxygen cylinder. Supply of oxygen to the system is controlled by a shut-off valve on the oxygen console. The pressure gage indicates the supply of oxygen available (1850 psig is nominal pressure for a full supply in the cylinder).

The system regulator is altitude compensated to provide a varying flow of oxygen with altitude. Flow is varied automatically from 0.5 liters per minute at 5,000 feet to 3.5 liters per minute at 30,000 feet. The use oxygen is recommended to be in accordance with current FAR operating rules.

PITOT AND STATIC SYSTEMS

PITOT SYSTEM

The pitot systems provides a source of impact air for operation of the airspeed indicator. The pitot mast is located on the leading edge of the left wing.

PITOT HEAT (Optional)

The pitot mast is provided with an electric heating element which is turned on and off with a switch on the instrument panel. The switch should be ON when flying in visible moisture. It is not advisable to operate the pitot heating element on the ground except for testing or for short intervals of time to remove ice or snow.

NORMAL STATIC AIR SYSTEM

The normal static system provides a source of static air to the flight instruments through a flush static fitting on each side of the airplane fuselage. Aft of the rear closure bulkhead (rear seat panel) is a drain plug, located at the low point of the normal static system. It is provided in order to drain moisture accumulations from the system. The closure bulkhead is held in place with Velcro and may be removed by pulling forward. The drain plug should be removed and the moisture drained from the clear plastic line every 100 hours and after exposure to visible moisture, either in the air or on the ground.

EMERGENCY STATIC AIR SYSTEM

An emergency static air source, if installed, provides air for instrument operation should the static ports become blocked. Refer to the EMERGENCY PROCEDURES Section for procedures describing how and when to use this system.

INSTRUMENT PRESSURE SYSTEM

Instrument pressure is supplied by an engine driven pressure pump. Pressure is controlled by an adjustable pressure regulator on the forward side of the firewall.

Section VII
Systems Description

BEEHCRAFT Bonanza F33A
CE-290 thru CE-673

A gage located in the upper right corner of the instrument panel indicates the system pressure in inches of mercury. The pressure should be maintained within the green arc for proper operation of the pressure operated instruments.

STALL WARNING

A stall warning horn on the forward side of the instrument panel sounds a warning signal as the airplane approaches a stall condition. The horn is triggered by a sensing vane on the leading edge of the left wing and is effective at all flight attitudes. Irregular and intermittent at first, the warning signal will become steady as the airplane approaches a complete stall.

ENGINE BREAK-IN INFORMATION

Use a straight mineral oil as recommended by the engine manufacturer throughout the break-in period. Drain the initial oil at 20 to 30 hours, replace with new mineral oil which is to be used until oil consumption stabilizes, usually a total of about 50 hours.

Drain and replace the engine oil as recommended in **HANDLING, SERVICING AND MAINTENANCE**. If operating conditions are unusually dusty or dirty, more frequent oil changes may be necessary. Oil changes are more critical during the break-in period than at any other time.

Use full throttle at recommended rpm for every take-off and maintain until at least 400 feet AGL, then reduce as necessary for cruise climb or cruise. Maintain the highest power recommended for cruise operations during the break-in period, avoiding altitudes above 8000 feet. Interrupt cruise power every 30 minutes or so by smoothly advancing to take-off power settings for about 30 seconds, then returning to cruise power settings.

BEEHCRAFT Bonanza F33A
CE-290 thru CE-673

Section VII
Systems Description

Avoid long power-off descents especially during the break-in period. Maintain sufficient power during descent to permit cylinder head temperatures to remain in the green arc.

Minimize ground operation time, especially during warm weather. During the break-in period, avoid engine idling in excess of 15 minutes, especially in high ambient temperatures.

SERVICING

FUEL SYSTEM

FUEL CELLS

See Consumable Materials for recommended fuel grades.

CAUTION

Never leave the fuel cells completely empty for more than a few days, as the cell inner liners may dry out and crack, permitting fuel to diffuse through the walls of the cell after refueling. If the cells are to be left empty for a week or more, a thin coating of light engine oil should be sprayed or flushed onto the inner liner of the cells.

The standard fuel cell installation consists of a 25-gallon capacity fuel cell (22-gallon usable) and filler cap in each wing leading edge. In the optional installation a 40-gallon capacity fuel cell (37-gallon usable) replaces the smaller capacity cell. The filler neck in this installation contains a visual measuring tab to permit partial filling of the tank. Filling the tank until the fuel touches the bottom of the tab indicates 27 gallons of usable fuel, and filling to the slot in the tab indicates 32 gallons of usable fuel. The airplane must be level for the tabs to indicate accurately.

FUEL DRAINS

Open the three snap-type fuel drains daily to purge any water from the system. Each fuel cell drain is located on the bottom of the wing just outboard of the fuselage. The system low spot drain is at the bottom of the fuel selector valve. The drain is accessible through a door in the fuselage adjacent to the left wing.

FUEL STRAINERS

At each 50 hour inspection the strainer plug should be removed from the fuel injection control valve and the fuel injection control valve screen washed in fresh cleaning solvent. After the strainer plug has been reinstalled and safetied, the installation should be checked for leakage. The strainer at the bottom of the fuel selector valve should also be removed and cleaned with solvent every 100 hours. To reduce the possibility of contaminated fuel, always cap any disconnected fuel lines or fittings.

Ordinarily the finger strainers in the fuel cell outlets should not require cleaning unless there is a definite indication of solid foreign material in the cells or the airplane has been stored for an extended period.

OIL SYSTEM

CAUTION

During break-in periods on new engines, oil consumption tends to be higher, therefore, maximum range flights should be avoided and oil level brought to full after each flight during this period.

The engine oil filler cap and dipstick is accessible by raising the left cowl door. The sump capacity is 12 quarts. Normal operating level should be 10 to 12 quarts.

The oil and filter element should be changed every 100 hours under normal operating conditions. To assure complete drainage, the engine should be at operating temperature.