



Jabiru Aircraft
Model J170-C
PILOT'S OPERATING HANDBOOK

Revision 0

THIS DOCUMENT MUST BE CARRIED IN THE AIRCRAFT AT ALL TIMES



AIRCRAFT PARTICULARS

*THIS AIRCRAFT MUST BE OPERATED IN ACCORDANCE WITH THE APPROVED
DATA AND LIMITATIONS CONTAINED IN THIS MANUAL AT ALL TIMES.*

Registration Marks: _____
Manufacturer: Jabiru Aircraft Pty Ltd
Aircraft Serial Number: _____
Certification Categories: Light Sport Aircraft

Any person finding this Manual is requested to return it to Jabiru Aircraft



AMENDMENT RECORD SHEET

Amendment Date	Affected Sections	Affected Pages	Date Inserted	Signature



INTRODUCTION

This Operating Handbook has been prepared to comply with the requirements of ASTM F2245.

This Operating Handbook includes the information required of the Flight Training Supplement.

The basic handbook provides all the information, procedures and limitations required to operate the aircraft as a Light Sport Aircraft. Information, procedures and limitations relating specifically to other operations are provided in the appropriate supplement.

The operating procedures presented herein are the result of Jabiru Aircraft's knowledge and experience gained up to the date of issue or amendment of this handbook. The handbook is not intended to be a guide for basic flight instruction or as a training manual. It may be used for operational purposes only if kept in a fully amended state. It contains all the information considered necessary to safely operate the aircraft.

The operator must be thoroughly familiar with the aircraft and the contents of this handbook before initial operation. Thereafter the handbook should be reviewed periodically to enable the operator to maintain the highest level of familiarity with the aircraft, its controls and recommended operating procedures.

Pilot's Operating Handbook (POH)

The handbook is valid **only for the particular aircraft** identified on the AIRCRAFT PARTICULARS page, and unless subsequently amended, refers to the aircraft as originally delivered from the factory. The handbook consists of the following:

Basic POH

The basic POH provides all required details of the standard aircraft and the procedures required to operate it in the LSA category. Apart from the listing in Section 4, no other details of any optional equipment fitted at the factory will be found in the basic POH. Refer to the relevant supplement.

Supplements

Self contained supplements are provided in SECTION 10 of the POH to provide details and procedures associated with the fitment of specified optional and special purpose equipment.

Amendments

Any amendments to any page of the POH is to have an amendment date. All amendments are to be incorporated as soon as possible after their receipt and details entered into the appropriate amendment record sheet.



WARNINGS, CAUTIONS & NOTES

Definitions used in the POH such as **WARNING**, **CAUTION**, **NOTE** are employed in the following context:

WARNING

Operating procedures, techniques, etc. which if not followed correctly, may result in personal injury or death.

CAUTION

Operating procedures, techniques, etc. which if not strictly observed, may result in damage to the aircraft or to its installed equipment.

NOTE

Operating procedures, techniques, etc. which it is considered essential to highlight.



THREE-VIEW DRAWING

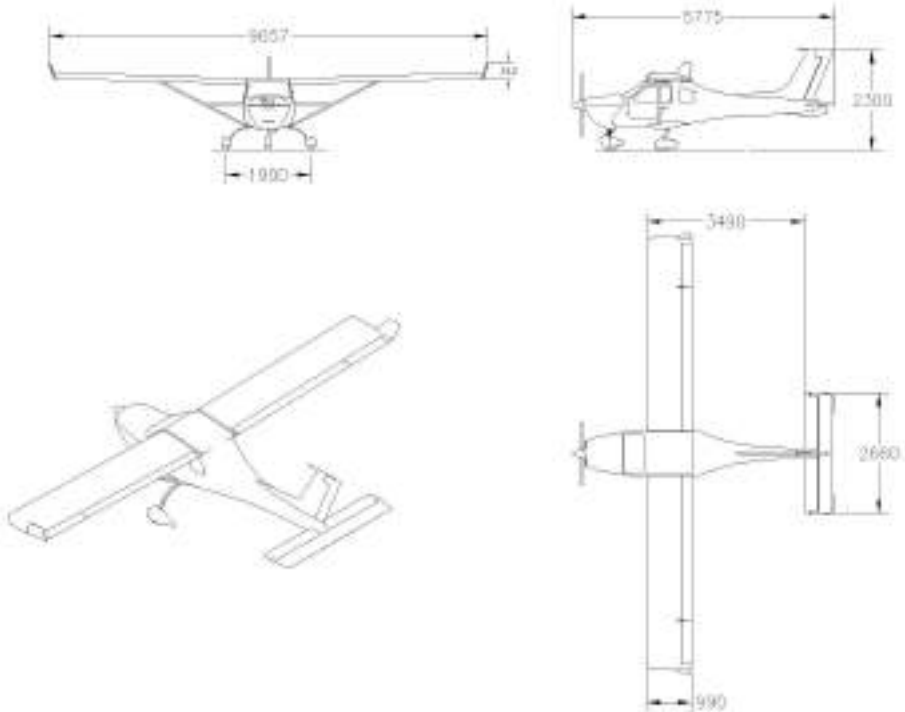

Figure 1-1 Three View Drawing of the J170-C

Note: All dimensions in millimetres



SYMBOLS, ABBREVIATIONS AND TERMINOLOGY

General Symbols and Abbreviations

A	Ampere
AGL	Above Ground Level
AMSL	Above Mean Sea Level
AVGAS	Aviation Gasoline
BHP	Brake Horse Power
CASA	Civil Aviation Safety Authority (Australia)
CAO	Civil Aviation Order (Australia)
CAR	Civil Aviation Regulation (Australia)
°C	Degrees Celsius
CHT	Cylinder Head Temperature
cm	Centimetre, centimetres
DC	Direct Current
FAA	Federal Aviation Administration (USA)
°F	Degrees Fahrenheit
FAR	Federal Aviation Regulation (USA)
ft	Foot, feet
ft/min	Feet per minute
g	Acceleration due to gravity
Gal	Gallon
hPa	Hectopascal, hectopascals
HF	High Frequency
ICAO	International Civil Aviation Organisation
IFR	Instrument Flight Rules
IMC	Instrument Meteorological Conditions
in	Inch, inches
in Hg	Inches of mercury
in lbs	Inch pounds
ISA	International Standard Atmosphere
kg	Kilogram
kg/l	Kilogram per litre
kHz	Kilohertz
kts, K	Knots
kPa	Kilopascals
kW	Kilowatt, kilowatts
l	Litre, litres
lb	Pound, pounds
LH	Left hand
LHS	Left hand side
m	Metre
m²	Square metre
m³	Cubic metre
mA	Milli ampere
MAC	Mean Aerodynamic Chord
max	Maximum
MHz	Megahertz
mm	Millimetre
min	Minimum or minute



MOGAS	Automotive Fuel
nm	Nautical mile, nautical miles
OAT	Outside Air Temperature
PAX	Passenger
POH	Pilots Operating Handbook
PROP	Propeller
psi	Pounds per square inch
QTY	Quantity
qts	Quarts
RH	Right Hand
RHS	Right Hand Side
RON	Fuel Octane Rating Scale (Research Octane Number)
RPM	Revolutions per minute
SAE	Society of Automotive Engineers
sec	Seconds
SQ	Square
STBY	Standby
TBO	Time between overhauls
T/O	Take Off
U/S	Unserviceable
USG	US Gallon
US Gal	US Gallon
V	Volts
VFR	Visual Flight Rules
VHF	Very High Frequency
VMC	Visual Meteorological Conditions

General Airspeed Terminology and Symbols

- **CAS** *Calibrated Airspeed:* the indicated speed of an aircraft corrected for position and instrument error. Calibrated airspeed is equal to true airspeed in standard atmosphere at sea level.
- **KCAS:** Calibrated Airspeed expressed in knots.
- **IAS** *Indicated Airspeed:* the speed of an aircraft as shown on the airspeed indicator. IAS values in this manual assume zero instrument error.
- **KIAS** Indicated Airspeed expressed in knots.
- **TAS** *True Air Speed:* the airspeed of an aircraft relative to the undisturbed air through which it passes.
- **T.O.S.S** *Take-Off Safety Speed:* the airspeed chosen to ensure that adequate control will exist under all conditions, including turbulence and sudden and complete engine failure during the climb after take-off. It is the speed required at 50 feet.
- **V_A** *Manoeuvring Speed:* the maximum speed at which application of full available aerodynamic control will not damage or overstress the aircraft.



- V_{FE} *Maximum Flap Extended Speed:* the highest speed permissible with wing flaps in a prescribed extended position.
- V_{NE} *Never Exceed Speed:* the limiting airspeed that may not be exceeded at any time.
- V_C *Maximum Structural Cruising Speed:* the speed that should not be exceeded except in smooth air and then only with caution.
- V_S *Stalling Speed:* or the minimum steady flight speed at which the aircraft is controllable.
- V_{SO} *Stalling Speed:* or the minimum steady flight speed at which the aircraft is controllable in the landing configuration.
- V_X *Best Angle-of-Climb Speed:* the airspeed which delivers the greatest gain of altitude in the shortest possible horizontal distance.
- V_Y *Best Rate-of-Climb Speed:* the airspeed which delivers the greatest gain in altitude in the shortest possible time.

Meteorological Terminology

- **OAT** – *Outside Air Temperature* – the outside free air static temperature.
- **Airfield Pressure Height** – The height registered at the surface of an aerodrome by an altimeter with the pressure sub-scale set to 1013 hPa (29.92 inches Hg).
- **Pressure Altitude** – Altitude measured from standard sea-level pressure (1013 hPa/29.92 inches Hg) by a pressure or barometric altimeter corrected for position and instrument error.
- **Indicated Pressure Altitude** – the altitude actually read from an altimeter when the pressure barometric sub-scale has been set to 1013 hPa (29.92 inches Hg).
- **QNH** – The local pressure setting that if set on the subscale of an altimeter will cause the altimeter to indicate local altitude above mean sea level.
- **Wind** – The wind velocities to be used as variables on aircraft performance are to be understood as the headwind or tail wind components of the reported winds.

Aircraft Performance and Flight Planning Terminology

- **Climb Gradient** – The ratio of the change in height during a climb, to the horizontal distance travelled.
- **Demonstrated Crosswind Component** – The crosswind component, during take-off and landing, for which adequate control of aircraft was actually demonstrated during certification tests.



Weight and Balance Terminology

- **Datum** – An imaginary vertical plane from which all horizontal distances are measured for balance purposes.
- **Station** – A location along the aircraft fuselage usually given in terms of distance from the reference datum.
- **Arm** – The horizontal distance from the reference datum to the centre of gravity (C of G) of an item.
- **Moment** – The product of the weight of an item multiplied by its arm.
- **Index Unit** – Moment divided by a constant. Used to simplify balance calculations by reducing the number of digits.
- **Centre of Gravity (C of G)** – The point at which an aircraft would balance if suspended. The distance from the C of G to the reference datum can be found by dividing the total moment by the total weight of the aircraft.
- **C of G Arm** – The arm obtained by adding the aircraft's individual moments and dividing the sum by the total weight.
- **C of G Limits** – The extreme centre of gravity locations within which the aircraft must be operated at a given weight.
- **Useable Fuel** – The quantity of fuel available for flight planning purposes.
- **Unusable Fuel** – The quantity of fuel (determined under adverse fuel flow conditions) that is not available for flight.
- **Empty Weight** – Weight of aircraft with unusable fuel and full oil.
- **Useful Load** – Difference between take-off weight, and basic empty weight.
- **Maximum Take-Off Weight** – Maximum weight approved for take-off.
- **Maximum Landing Weight** – Maximum weight approved for the landing.
- **Header Tank** – Fuel tank plumbed between the wing tanks and the engine. Also known as **Collector Tank** or **Sump Tank**.



USE OF METRIC/IMPERIAL UNITS

This POH uses the metric system as the basic system of measurement. Where common usage or available instrumentation refer to the Imperial/US unit system, both units are quoted. The following conversion factors are presented as a ready reference to the conversion factors that have been used in this manual as well as supplying some others that may be found useful.

1 Pound (lb)	=	0.4536 Kilogram (kg)
1 Pound per sq in (psi)	=	6.895 Kilopascal (kPa)
1 Inch (in)	=	25.4 Millimetres (mm)
1 Foot (ft)	=	0.3048 Metre (m)
1 Statute mile	=	1.609 Kilometres (km)
1 Nautical mile (NM)	=	1.852 Kilometres (km)
1 Millibar (mb)	=	1 Hectopascal (hPa)
1 Millibar (mb)	=	0.1 Kilopascal (kPa)
1 Imperial gallon	=	4.546 Litres (l)
1 US gallon	=	3.785 Litres (l)
1 US quart	=	0.946 Litre (l)
1 Cubic foot (ft ³)	=	28.317 Litres (l)
1 Acre	=	0.4047 Hectares
1 Degree Fahrenheit (EF)	=	[1.8 x EC]+32
1 Inch Pound (in lb)	=	0.113 Newton Metres (Nm)
1 Foot Pound (ft lb)	=	1.356 Newton Metres (Nm)



TABLE OF CONTENTS

Paragraph	Page
1	GENERAL INFORMATION.....14
1.1	MANUFACTURERS STATEMENT OF COMPLIANCE.....14
1.1	MANUFACTURER DETAILS15
1.2	LIGHT SPORT AIRCRAFT NOTIFICATION15
1.3	J170-C PERFORMANCE & SPECIFICATION SUMMARY15
2	AIRPLANE AND SYSTEMS DESCRIPTIONS16
2.1	ENGINE16
2.2	PROPELLER16
2.3	FUEL16
2.4	ENGINE OIL16
2.5	OPERATING WEIGHTS AND LOADING.....16
2.6	MINIMUM EQUIPMENT LIST.....17
3	OPERATING LIMITATIONS19
3.1	KINDS OF OPERATION19
3.2	AIRSPEED LIMITS19
3.3	CROSSWIND19
3.4	AIRCRAFT SERVICE CEILING.....19
3.5	LOAD FACTORS19
3.6	PROHIBITED MANOEUVRES20
3.7	POWERPLANT LIMITATIONS20
3.7.1	<i>Fuel Grade</i>20
3.7.2	<i>Lubricating Oil</i>21
3.8	POWERPLANT INSTRUMENT MARKINGS21
3.9	EFIS & EMS LIMITATIONS DISPLAY.....21
3.9.1	<i>Required EFIS limitation displays:</i>21
3.9.2	<i>Required EMS Displays:</i>21
3.10	POWER GENERATION SYSTEM LIMITATIONS.....22
3.11	OTHER LIMITATIONS.....22
3.12	PLACARDS.....22
3.12.1	<i>Cockpit Placards General</i>22
3.12.2	<i>Cockpit Controls</i>24
3.12.3	<i>External Fuselage</i>25
4	WEIGHT AND BALANCE INFORMATION.....27
4.1	CG RANGE.....27
4.2	BAGGAGE ZONES.....28
4.3	AIRCRAFT WEIGHT DATA.....29
4.4	TRIM SHEETS.....32
4.4.1	<i>Calculate Aircraft Weights</i>32
4.4.2	<i>Calculating the Operating CG Locations</i>33
4.4.3	<i>Allowable Loading Conditions</i>33
5	PERFORMANCE.....36
5.1	TAKE OFF AND LANDING DISTANCES.....36
5.2	RATE OF CLIMB.....36
5.3	CRUISE SPEEDS / RPM / FUEL CONSUMPTION36
5.4	AIRSPEED INDICATOR SYSTEM CALIBRATION.....37
6	EMERGENCY PROCEDURES38
6.1	AIRSPEEDS FOR EMERGENCY OPERATIONS.....38



6.2	EMERGENCY PROCEDURES CHECK LISTS	38
6.2.1	<i>Engine Failures</i>	38
6.2.2	<i>Airstart & Limitations</i>	39
6.2.3	<i>Forced Landings</i>	40
6.2.4	<i>Fires</i>	40
6.2.5	<i>Carburettor Icing</i>	42
6.2.6	<i>Fuel Low Pressure Warning Light Illuminates Continuously</i>	42
6.2.7	<i>Landing With a Flat Main Tyre</i>	42
6.2.8	<i>Inadvertent Icing Encounter</i>	42
6.2.9	<i>Electrical Power Supply System Malfunctions</i>	42
6.2.10	<i>Spins</i>	43
7	NORMAL PROCEDURES	44
7.1	GENERAL.....	44
7.2	SPEEDS FOR NORMAL OPERATION	44
7.3	BEST ANGLE OF CLIMB SPEED	44
7.4	BEST RATE OF CLIMB SPEED	44
7.5	PREFLIGHT INSPECTION.....	45
7.6	NORMAL PROCEDURES CHECK LISTS	48
7.6.1	<i>Before Starting Engine</i>	48
7.6.2	<i>Starting Engine - Cold</i>	48
7.6.3	<i>Before Take-Off</i>	48
7.6.4	<i>Take-Off</i>	49
7.6.5	<i>Initial Climb</i>	49
7.6.6	<i>Cruise</i>	49
7.6.7	<i>Descent</i>	49
7.6.8	<i>Before Landing (and flight below 1000ft AGL)</i>	49
7.6.9	<i>Landing</i>	49
7.6.10	<i>Balked Landing</i>	50
7.6.11	<i>After Landing/Securing</i>	50
7.6.12	<i>Short Field Take-Off</i>	50
7.6.13	<i>Short Field Landing</i>	50
7.6.14	<i>Engine Management – Ground Running</i>	51
8	AIRCRAFT GROUND HANDLING AND SERVICING	52
8.1	FUEL.....	52
8.2	OIL.....	52
8.2.1	<i>Engine Oil Specification</i>	52
8.2.2	<i>Engine Oil Viscosity Grade</i>	52
8.3	BRAKES	53
9	CLIMATIC RESTRICTIONS.....	54
10	SUPPLEMENTS	55
10.1	LOG OF SUPPLEMENTS – JABIRU AIRCRAFT SUPPLEMENTS	56



1 GENERAL INFORMATION

1.1 MANUFACTURERS STATEMENT OF COMPLIANCE

INSERT COPY OF MANUFACTURERS STATEMENT OF COMPLIANCE



1.1 MANUFACTURER DETAILS

Jabiru Aircraft P/L
PO Box 5186
Bundaberg West,
QLD 4670
Phone: 07 4155 1778
Fax: 07 4155 2669
Email: info@jabiru.net.au

Street Address:

Jabiru Aircraft
Airport Drive, Hinkler Airport
Bundaberg
QLD 4670

1.2 LIGHT SPORT AIRCRAFT NOTIFICATION

There are inherent risks in the participation in recreational aviation aircraft. Operators and passengers of recreational aviation aircraft, by participation, accept the risks inherent in such participation of which the ordinary prudent person is or should be aware. Pilots and passengers have a duty to exercise good judgment and act in a responsible manner while using the aircraft and to obey all oral or written warnings, or both, prior to or during use of the aircraft, or both.

1.3 J170-C PERFORMANCE & SPECIFICATION SUMMARY

Gross Weight	600kg (1323 lb)
Top Speed at Sea Level	120 KCAS
Full Fuel Range ¹	770nm at 75% power 1030 nm at most efficient power setting
Rate of Climb at Sea Level ²	550 fpm
Take-Off Distance	475 m
Landing Distance	468 m
Stall Speed Clean	45 KCAS
Stall Speed Flaps Full Down	40 KCAS
Fuel Capacity	135 L Useable
Approved Fuels	AVGAS or MOGAS with RON of 95 or higher.
Maximum Engine Power	80 hp @ 3300 RPM.

Refer to the main body of this handbook below for more information.

¹ Range with 45 minute reserve at stated power setting

² At Gross Weight, ICAO Standard Atmosphere



2 AIRPLANE AND SYSTEMS DESCRIPTIONS

2.1 ENGINE

Manufacturer: Jabiru Aircraft Pty Ltd
Model: 2200B

2.2 PROPELLER

Manufacturer: Jabiru Aircraft Pty Ltd
Model: C000262-D60P42
Type: Wooden, Fixed Pitch
Number of blades: 2
Diameter: 1524 mm (60 in)
Pitch: 1067 mm (42 in)
Max RPM: 3300

2.3 FUEL

Capacity: 135L Total Useable (2 OFF 67.5L Wing Tanks)
Grade: Avgas 100LL
Avgas 100/130
MOGAS with minimum Octane Rating of 95 RON may be used.

Refer to Section 3 for additional details.

2.4 ENGINE OIL

Jabiru Aircraft approves lubricating oils of any brand name conforming to specifications MIL-L-6082 for straight mineral oil and MIL-L-22851 for ashless dispersant oil.

Refer to Section 3 for additional details.

2.5 OPERATING WEIGHTS AND LOADING

Max Take-Off & Landing Weight:	600 kg (1323 lb)
Maximum Baggage	18kg behind each seat – 36kg total
Forward Limit:	180-mm (7.09", 18.2%MAC) aft of datum up to & including 440 kg (970lb) 255-mm (10.0", 25.8%MAC) aft of datum at 600kg (1323lb) Linear variation between points.
Aft Limit	287-mm (11.3", 29.0%) aft of datum at all weights
Datum	Wing Leading Edge
Levelling Means	
Longitudinal	Spirit Level placed on the lower section of the door frames



	(left or right side).
Lateral	Spirit Level placed across the fuselage between the left and right side lower door frames.
Arms	
Arm for Front Seat Station	297-mm aft of datum
Arm for Baggage On Shelf	920-mm aft of datum
Fuel Station	451-mm aft of datum

Refer to Section 4 for additional details.

2.6 MINIMUM EQUIPMENT LIST

System Instruments and/or Equipment	VFR Day	Remarks
Communications		
VHF Comm	A/R	As required per local operating regulations
Electrical Power		
Alternator	1	
Battery	1	
Voltage Indicator	1	
Fire Protection		
Portable Fire Extinguisher	A/R	As required per local operating regulations
Flight Controls		
Pitch Trim Indicator	1	
Pitch Trim System	1	
Flap Position Indicator	1	
Stall Warning System	1	
Fuel		



System Instruments and/or Equipment	VFR Day	Remarks
Fuel Quantity Indicator	2	
Fuel On/Off Valve	1	
Ice & Rain Protection		
Engine Alternate Air Induction System	1	
Navigation & Pitot Static		
Altimeter	1	
Airspeed Indicator	1	
Magnetic Compass	1	
Time Piece	1	May be carried on the pilot
Turn Co-ordinator	A/R	As required per local operating regulations
Pitot/Static System	1	
Transponder	A/R	As required per local operating regulations
Engine Indicating		
Cylinder Head Temperature	1	
Tachometer	1	
Oil Pressure	1	
Oil Temperature	1	
Fuel Pressure	1	
Oil Quantity (Dip Stick)	1	
Caution Warning System	1	Fuel, electrical, and vacuum systems
Approved Pilot's Operating Handbook	1	



3 OPERATING LIMITATIONS

3.1 KINDS OF OPERATION

The standard J170-C, as detailed within this POH, is approved for Day VFR Operations only.

An optional package is available to allow the aircraft to conduct Night VFR Operations. Physically this package consists of additional lights and equipment. Aircraft approved for Night VFR Operations must also have such operations approved on their Certificate of Airworthiness and must carry the Jabiru J170-C Night VFR Operations Supplement (Document Number JP-MS-05).

Note

Carrying out Night VFR Operations without a valid Certificate of Airworthiness, Night VFR Supplement & properly equipped aircraft is illegal. Pilots must ensure the aircraft is appropriate for the intended operations.

3.2 AIRSPEED LIMITS

SPEED	KCAS	REMARKS
Max Manoeuvring Speed (V_A)	90	Do not make full or abrupt control movements above this speed.
Never Exceed Speed (V_{NE})	140	Do not exceed this speed in any operation.
Max Structural Cruising Speed (V_C)	108	Do not exceed this speed except in smooth air and then with caution.
Maximum Flap Extension Speed (V_{FE})	80	Do not exceed this speed with the flaps deployed.
Stalling Speed (V_S)	45	in Cruise Configuration
Stalling Speed (V_{SO})	40	in Landing Configuration

Note: Refer to Section 5.4 for Indicated Airspeed limitations.

3.3 CROSSWIND

The maximum allowable crosswind velocity is dependant on pilot capability as well as aircraft limitations. With average pilot technique, direct crosswinds of 14 knots can be handled with safety.

3.4 AIRCRAFT SERVICE CEILING

10 000 feet ASL.

3.5 LOAD FACTORS

Flap Position	Speed	Positive	Negative
UP	V_A	+ 4g	-2g
UP	V_{NE}	+ 4g	-2-g
DOWN	V_{FE}	+ 2.0g	0g



3.6 PROHIBITED MANOEUVRES

Manoeuvres in the course of normal flying are approved.

Stalls may be carried out at bank angles of up to 60°. All aerobatic manoeuvres including spins are prohibited.

3.7 POWERPLANT LIMITATIONS

	POWER	RPM	Maximum Temperatures		Fuel Pressure Limits		Oil Pressure Limits	
			Cyl Head	Oil	Min	Max	Min	Max
Absolute Limits	Maximum Take-Off (80 BHP)	3300	200 °C (392°F) (Note #1)	118°C (244°F)	5 kPa (0.75psi)	20 kPa (3psi)	220 kPa (31 psi)	525 kPa (76psi)
Continuous Limits	Maximum Cont (80 BHP)	3300	180°C (356°F)	100°C (212°F)	5 kPa (0.75psi)	20 kPa (3psi)	220 kPa (31 psi)	525 kPa (76 psi)
Limits For Ground Running	N/A	N/A	180°C (356°F) (Note #2)	100°C (212°F) (Note #2)	5 kPa (0.75psi)	20 kPa (3psi)	80 kPa (11 psi)	525 kPa (76 psi)

Note #1 Time with CHT at between 180°C and 200°C is not to exceed 5 Minutes

Note #2 If temperature limits are reached, shut the engine down or cool it by pointing the aircraft into wind.

Other limits are as follows:

- Minimum oil pressure at idle: 80 kPa (11 psi)
- Maximum oil pressure at start: 525 kPa (76 psi)

3.7.1 Fuel Grade

- Avgas 100LL
- Avgas 100/130
- MOGAS with minimum Octane Rating of 95 RON may be used.
- Do not use fuel additives such as Octane Boosters.

NOTE

As there are significant variations possible even between automotive fuels with the same values of RON, Jabiru Aircraft strongly recommend using AVGAS. Automotive fuels should only be used where AVGAS is not available, and if used, must have the highest anti-detonation rating practically available.

CAUTION

*Fuel additives containing alcohol (i.e. Ethanol etc) will damage the sealant used in the fuel tanks. **DO NOT** use MOGAS with any level of added alcohol.*



3.7.2 Lubricating Oil

Oil Capacity 2.3 Litres.

Refer to Section 8.2 for additional details.

3.8 POWERPLANT INSTRUMENT MARKINGS

Instrument	Red Line Minimum Limit	Green Arc Normal Operating	Red Arc/Line Maximum Limit	Yellow Arc Precautionary Range
Tachometer	-	-	3300 RPM	-
Cylinder Head Temperature	-	Up to 180°C (356°F)	200°C (392°F)	180°C - 200°C (356° - 392°F)
Oil Pressure	80 kPa (11 psi)	220 - 525 kPa (31 – 76 psi)	525 kPa (76 psi)	80 - 220 kPa (11- 31psi)
Oil Temperature	15°C (59°F)	80 - 100°C (176° - 212°F)	118°C (244°F)	100°C - 118°C (212 °- 244°F)
Fuel Pressure	5 kPa (0.75psi)	5 – 20 kPa (0.75 – 3 psi)	20 kPa 3 psi	-
Voltage	-	10.5 – 15 Volts	-	-

3.9 EFIS & EMS LIMITATIONS DISPLAY

Where aircraft are equipped with EFIS or EMS displays, they are programmed to display limitations and alarms etc as a part of their installation into the aircraft. These limitations must be displayed for the aircraft to comply with it's certification basis. If adjustments are required to the displays the work must be carried out before further flight by an authorised person with reference to the user manuals for the instruments, and the following lists give the minimum information which must be displayed.

3.9.1 Required EFIS limitation displays:

- Never exceed speed, V_{NE} (Red line speed, top of yellow arc)
- Maximum structural cruising speed, V_C (Top of green arc, bottom of yellow arc)
- Maximum Flap Extension speed, V_{FE} (Top of white arc)
- Stall speed with full flap, V_{S0} (Bottom of white arc)
- Stall speed clean, V_{S1} (bottom of green arc)

3.9.2 Required EMS Displays:

- RPM Red line
- Maximum continuous CHT (Top of CHT green arc, bottom of yellow arc)
- Maximum Take-Off CHT (Red line for CHT, top of yellow arc – no more than 5 minutes)
- Maximum continuous Oil Temperature (Top of oil temp green arc, bottom of yellow arc)
- Maximum Take-Off Oil Temperature (Red line for oil temp, top of yellow arc)
- Minimum Fuel Pressure (start of green arc)
- Maximum Fuel Pressure (end of green arc)
- Minimum Idle Oil Pressure (Redline & start of yellow arc)
- Minimum Flight Oil Pressure (end of yellow arc, start of green arc)
- Maximum Oil Pressure (End of green arc)



- Minimum System Voltage (Bottom of green arc)
- Maximum System Voltage (top of green arc)

Note

The display of these limitations are required for the aircraft's certification, and it does not comply with the certification basis if these limits are missing or modified.

3.10 POWER GENERATION SYSTEM LIMITATIONS

When the engine is turning at approximately 2000 RPM and above the alternator produces sufficient power for all lights to be run continuously. However, below this RPM the alternator cannot produce this power output and power must be drawn from the battery if all electrical systems are running. To reduce the load on the alternator, Jabiru Aircraft recommend only using the Landing Light for takeoff and landing – turning it off during normal cruise operations and wherever safe while taxiing.





3.11 OTHER LIMITATIONS

- Smoking is prohibited.
- In-cabin noise levels exceed 95db. Hearing protection must be worn.



3.12 PLACARDS

The following placards are required, and are to be located in the proximity indicated.

3.12.1 Cockpit Placards General

Warning Placard P/No. 5A069A0D	 Fitted on the rear Face of the Forward Wing Spar Carry-through Beam in the Cabin Ceiling.
No Smoking P/No. 5A035A0D	 Fit to instrument panel.
No Intentional Spins. P/No. 5A072A0D	 Fit to Instrument Panel
Owners Manual P/No 5A075A0D	 Fitted to Inside of RH Door above the Door Pocket.
Door Open LHS P/No 5027094	 Fitted to the Outsides of LH Door Above the Door Catch Lever

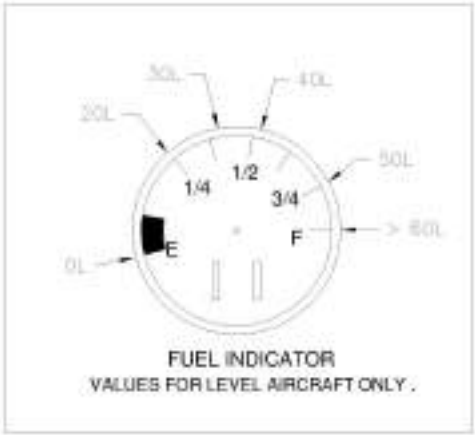

<p>Door Open RHS P/No 5028094</p>	<div style="text-align: center;">  <p>OPEN</p> </div> <p>Fitted to the outside of RH Door Above the Door Catch Level</p>																												
<p>Door String Placard P/No 5026094</p>	<div style="text-align: center;">  <p>PULL TO OPEN</p> </div> <p>Fitted on Inside of both Doors Above Door Handle.</p>																												
<p>Fuel Gauge P/No. 5A050A0D Where Equipped</p>	<div style="text-align: center;">  <p>FUEL LEVEL WING TANKS</p> </div> <p>Fitted on the instrument panel immediately below fuel gauges.</p>																												
<p>Electric Fuel Gauge Quantities. P/No. 5A053A0D Where Equipped.</p>	<div style="text-align: center;">  <p>FUEL INDICATOR VALUES FOR LEVEL AIRCRAFT ONLY.</p> </div> <p>Fit inside wing root immediately aft of windows through to electric fuel gauge senders</p>																												
<p>Compass Card P/No. 5123024</p>	<div style="text-align: center;"> <table border="1" data-bbox="493 1102 848 1289"> <tr> <td>For</td> <td>N</td> <td>30</td> <td>60</td> <td>E</td> <td>120</td> <td>150</td> </tr> <tr> <td>Steer</td> <td></td> <td></td> <td></td> <td></td> <td></td> <td></td> </tr> <tr> <td>For</td> <td>S</td> <td>210</td> <td>240</td> <td>W</td> <td>300</td> <td>330</td> </tr> <tr> <td>Steer</td> <td></td> <td></td> <td></td> <td></td> <td></td> <td></td> </tr> </table> <p><small>Correction for scale in in standard mode Date: P/No 5123024</small></p> </div> <p>Fit in compass card holder attached to compass.</p>	For	N	30	60	E	120	150	Steer							For	S	210	240	W	300	330	Steer						
For	N	30	60	E	120	150																							
Steer																													
For	S	210	240	W	300	330																							
Steer																													







<p>Baggage P/No. 5A037A0D</p>	 <p>Fit to right side fuselage wall immediately below window.</p>
<p>Baggage P/No. 5A074A0D</p>	 <p>Fit to inside of fuselage on right side just below rear quarter window. Locate vertical line in line with rear of baggage shelf.</p>
<p>Loading Limitations P/No 5A073A0D</p>	 <p>Fitted on inside of fuselage of RHS of cabin below rear quarter window.</p>

Table 2.15.1

3.12.2 Cockpit Controls

<p>Trim Position P/No. 5A031A0D (1 OFF)</p>	 <p>Fit to centre console beside of elevator fwd stop, between trim levers.</p>
---	--











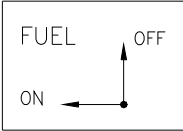

<p>Brake On P/No. 5A031B0D</p>	 <p>Fit to centre console beside brake lever, arrow pointing aft.</p>
<p>Fuel Tap Position P/No 502319N</p>	 <p>Fitted on the Main Beam in front of the Fuel SELECTOR Valve</p>
<p>Carby Heat P/No 5A030A0D</p>	 <p>Fitted to lower central section of instrument panel.</p>

Table 2.15.2

3.12.3 External Fuselage

<p>Static Port P/No 5043094</p>	<div style="border: 2px solid black; padding: 5px; text-align: center;"> <p>STATIC VENT KEEP CLEAR</p> </div> <p>Attach to LHS of Vertical Fin in line with Static Tube</p>
<p>Fuel Grade- Wing Tanks P/No 5091344</p> <p>2 OFF</p>	<div style="border: 1px solid black; padding: 10px; text-align: center;"> <p>FUEL</p> <hr style="width: 20%; margin: 0 auto;"/> <p>AVGAS 100LL 67 LITRE CAPACITY EARTH ON POST</p> </div> <p>Attach to top skin of wing adjacent to Fuel Filler Cap.</p>
<p>Nose Wheel Inflation. P/No. 5A062A0D</p>	 <p>Attach to left side of nose wheel spat.</p>
<p>Main Wheel Inflation. P/No. 5A061A0D</p>	 <p>Attach to outsides of main wheel spats</p>



<p>Engine Oil P/No. 5A008A0D</p>	<div style="text-align: center;">  </div> <p style="text-align: center;">Attach to inner face of door in top engine cowl.</p>
<p>Dipstick Inside P/No. 5A007A0D</p>	<div style="text-align: center;">  </div> <p style="text-align: center;">Fit to outside of oil door in upper engine cowl.</p>
<p>Door Lean. P/No. 5A013A0D</p>	<div style="text-align: center;">  </div> <p style="text-align: center;">Fit to top of doors.</p>
<p>Wing Bolt Tightening P/No 5039094 Qty 8 Required</p>	<div style="text-align: center;"> <div style="border: 2px solid black; padding: 5px; display: inline-block;"> <p>DANGER DO NOT TIGHTEN</p> </div> </div> <p style="text-align: center;">Attach to the fuselage and wings beside each wing, and lift strut attachment fitting.</p>
<p>Earth on Post P/No. 5A066A0D</p>	<div style="text-align: center;">  </div> <p style="text-align: center;">Attach to upper wing skin beside fuel filler earth post.</p>
<p>No Step P/No. 5A006A0D Qty 2 required.</p>	<div style="text-align: center;">  </div> <p style="text-align: center;">Fit to top of main wheel spats</p>
<p>Earth on Exhaust P/No. 5029094</p>	<div style="text-align: center;">  </div> <p style="text-align: center;">Attach to the lower fuselage on the pilot's side immediately above the exhaust outlet pipe.</p>



4 WEIGHT AND BALANCE INFORMATION

4.1 CG RANGE

Forward Limit:	180-mm (7.09", 18.2%MAC) aft of datum up to & including 440 kg (970lb) 255-mm (10.0", 25.8%MAC) aft of datum at 600kg (1323lb) Linear variation between points.
Aft Limit	287-mm (11.3", 29.0%) aft of datum at all weights
Datum	Wing Leading Edge
Levelling Means	
Longitudinal	Spirit Level placed on the lower section of the door frames (left or right side).
Lateral	Spirit Level placed across the fuselage between the left and right side lower door frames.
Arms	
Arm for Front Seat Station	297-mm aft of datum
Arm for Baggage On Shelf	920-mm aft of datum
Fuel Station	451-mm aft of datum

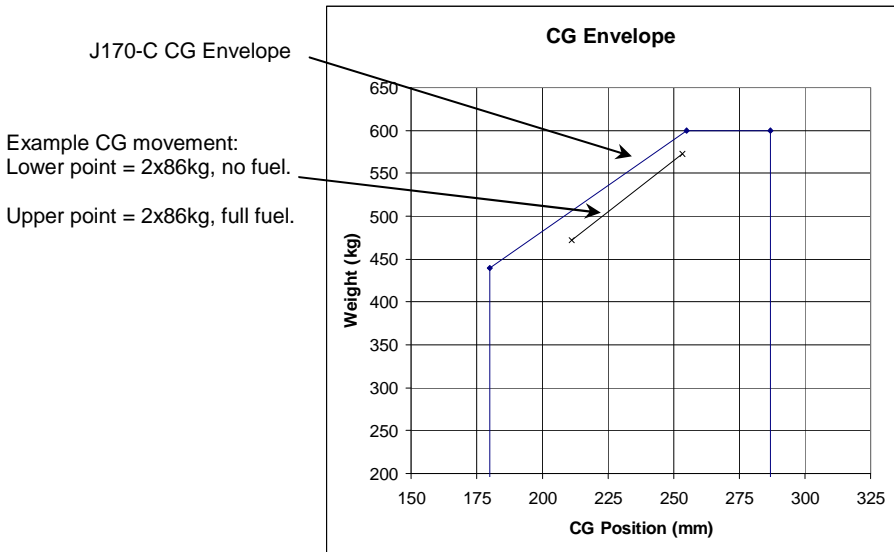

4.2 Baggage Zones

The cabin has one baggage zone:

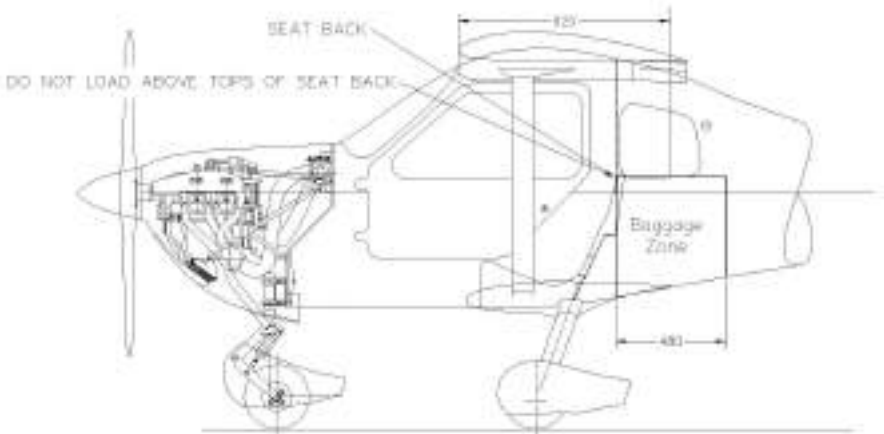

Figure 6.3.1 – Baggage Zones

Baggage is restrained using the straps fitted in the baggage areas.



4.3 AIRCRAFT WEIGHT DATA

Insert Page 6.2 here



Insert Page 6.3 here



Insert Equipment List here.



4.4 TRIM SHEETS

The trim sheets included below, when used correctly, provide a means of calculating the aircraft weight and CG position without manual calculations. An example of using the sheet is included for reference.

4.4.1 Calculate Aircraft Weights

- 1-1 Use the Aircraft Empty Weight obtained from the latest aircraft weighing records to enter the vertical "Aircraft Empty Weight Scale" on right hand side of the chart.
- 1-2 Move horizontally to the left into the next scale which is the "Crew Weight" Scale.
- 1-3 Move vertically downward one line on this scale for each 10-kg of weight that is placed on the front seats, and mark a point.
- 1-4 Move horizontally to the left from the point made in Step 1-3 to enter the next scale which is the "Baggage Weight" Scale.
- 1-5 Move vertically downward one line on this scale for each 5-kg of weight that is placed in Baggage Zone and mark a point.
- 1-6 Move horizontally to the left from the point made in Step 1-7 to enter the next scale which is the "Fuel Quantity" Scale and mark a point, This point is the "Zero Fuel Weight Reference Point"
- 1-7 Move Horizontally to the left of the "Zero Fuel Reference Point" and Mark a "Zero Fuel Weight Line" across the "Aircraft Trim Condition" Graph.
- 1-8 From the "Zero Fuel Point" on the "Fuel Quantity Scale" (marked in Step 1-8), move vertically downward one line for each 10-**litres** of fuel being carried at the take-off condition. Mark this "Take-Off Fuel Point" on the scale.
- 1-9 Move horizontally to the left, and mark a "Take-Off Fuel Weight Line" across the "Aircraft Trim Condition" graph.



4.4.2 Calculating the Operating CG Locations

- 2-1. Take the calculated Empty Weight Trim Index and mark it's position on the Aircraft Index Units Ladder at the top of the sheet.
- 2-2. Draw a vertical line down from the point marked above to intersect with a sloping line in the "Crew Index Units" scale and mark this point.
- 2-3. Calculate the weight of the crew and round this value to the nearest 10-kg.
- 2-4. Move horizontally to the right from the point marked in Step 2-2 one line for each 10-kg of load calculated. (i.e. 60-kg = 6 lines) and mark a point at this location.
- 2-5. Draw a vertical line down from the point marked above to intersect with a sloping line in the Baggage Area scale and mark this point.
- 2-6. Calculate the weight that will be placed Baggage Area and round this value to the nearest 5-kg.
- 2-7. Move horizontally to the right from the point marked in Step 2-5 one line for each 5-kg of load calculated. (i.e. 20-kg = 4 lines) and mark a point at this location.
- 2-8. Drop a vertical line down from the point marked in Step 2-10 to intersect a sloping line in "Fuel Chart", and mark a point at this location.
- 2-9. Continue the Vertical Line began in Step 2-11 down to intersect with the "Zero Fuel Weight Line" drawn in Step 1-9. mark this point as the "ZERO FUEL Condition"
- 2-10. Move horizontally to the right from the point marked in Step 2-11 in the "Take-Off Fuel Box", one line for each 10 liters of take-off fuel, and mark this point.
- 2-11. Move vertically downward from the take-off fuel point marked in Step 2-13 to intersect with the "Take-Off Fuel Weight Line" marked in Step 1-9. Mark this point the "Take-Off Condition"

4.4.3 Allowable Loading Conditions

An allowable loading condition exists when both the "Zero Fuel Condition", and the "Take-Off Condition" fall with the area bounded by the Line in the Aircraft Trim Conditions Box.

For reference, the example below shows two 90kg people, 5kg in Baggage Zone and 60L of fuel. The aircraft's starting Index Unit is 49.5 at 275kg.



ORIGINAL

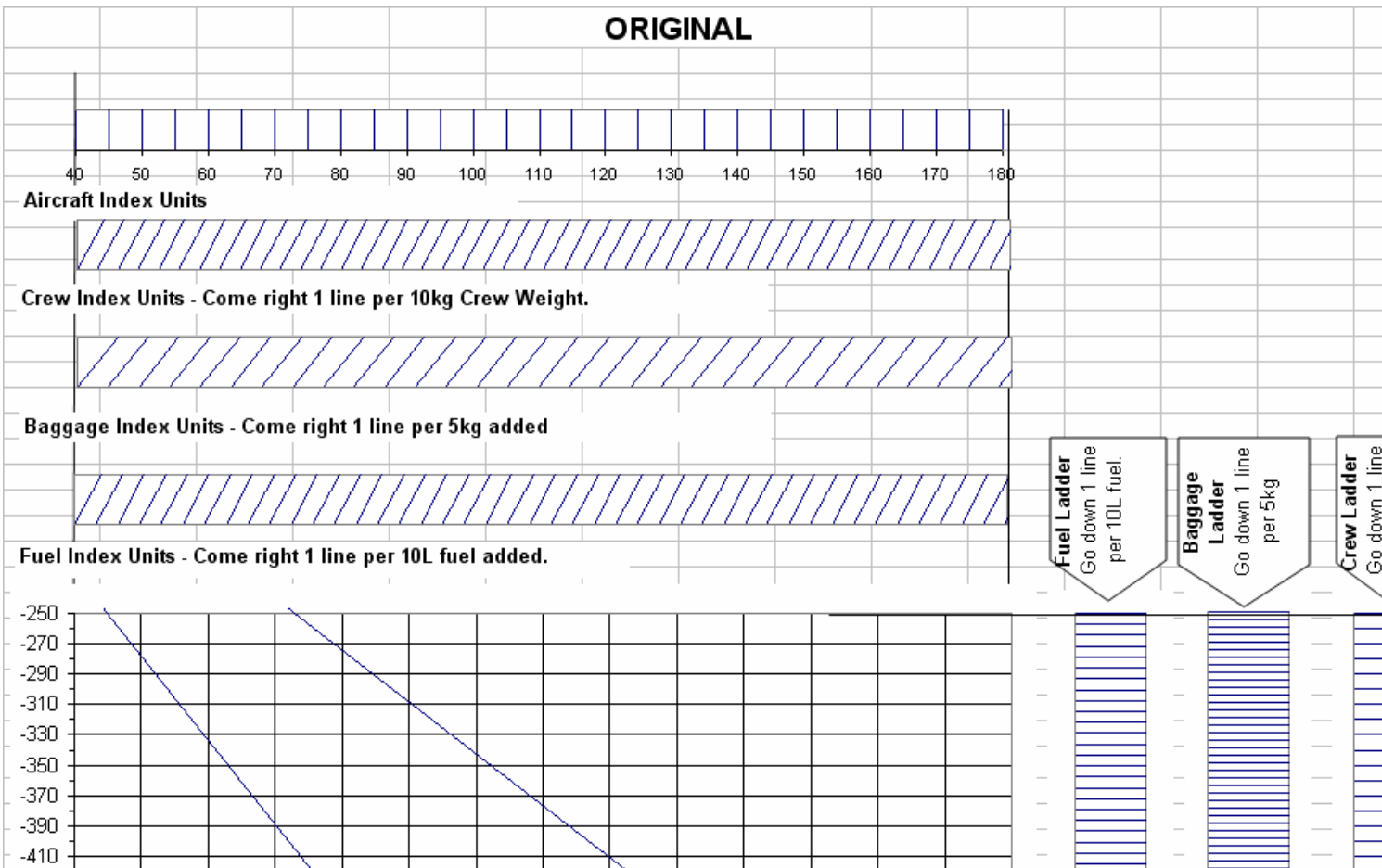



EXAMPLE

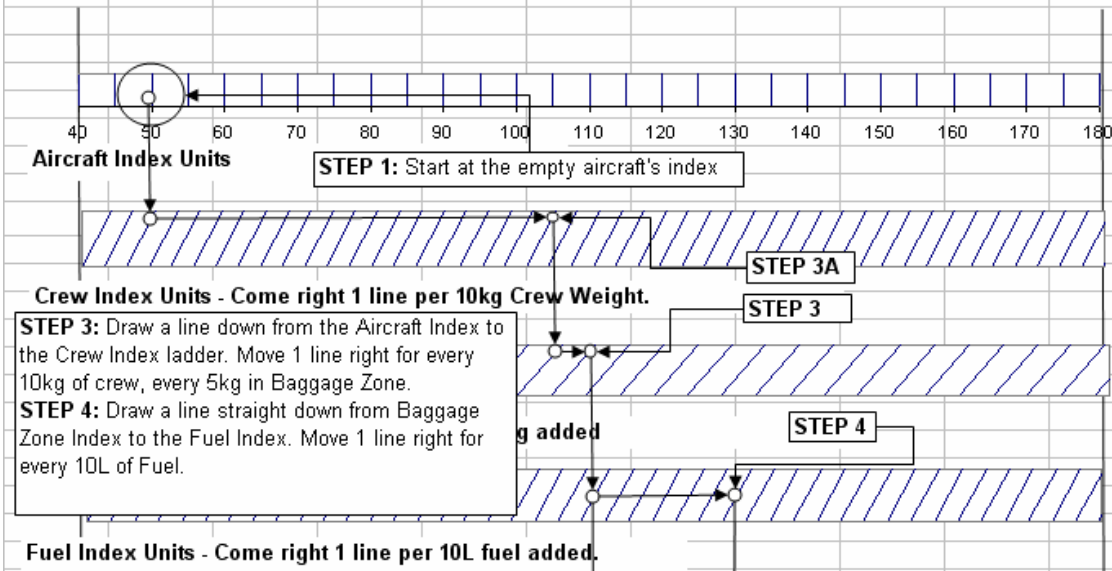

Fuel Ladder
Go down 1 line per 10L fuel.

Baggage Ladder
Go down 1 line per 5kg

Crew Ladder

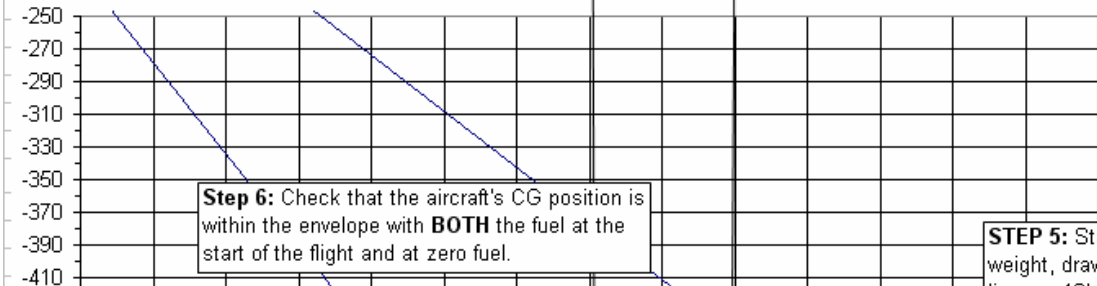

STEP 5: Starting from the aircraft empty weight, draw a line as shown, coming down 1 line per 10kg of weight added.



5 PERFORMANCE

5.1 TAKE OFF AND LANDING DISTANCES

Take-Off Distance 475 m

Landing Distance 468 m

Note:

All distances quoted are for an aircraft at gross weight, operating from a paved runway surface at sea level in an ICAO standard atmosphere.

5.2 RATE OF CLIMB

Rate of Climb at Sea Level³ 550 fpm

Note:

All distances quoted are for an aircraft at gross weight, operating from a paved runway surface at sea level in an ICAO standard atmosphere.

5.3 CRUISE SPEEDS / RPM / FUEL CONSUMPTION

- Cruise speed values given are based on tests carried out at gross aircraft weight, at sea level and around 28°C. Values are averaged. Actual values will vary slightly from one aircraft to the next. Values used for flight planning should be based on previous experience with the specific aircraft wherever possible.
- Fuel consumption values given are averaged. Actual values will vary slightly from one aircraft to the next. Values used for flight planning should be based on previous experience with the specific aircraft wherever possible.

RPM	Fuel Consumption (Litres/hr)	IAS (Knots)
2600	11	85
2700	13	91
2800	15	95
2850	16	97
2900	17	99
3000	20	103

³ At Gross Weight, ICAO Standard Atmosphere



5.4 Airspeed Indicator System Calibration

Conditions:

Power: As required for level flight or maximum rated RPM as appropriate.

KIAS	KCAS		
	Flaps UP	Flaps Take-off	Flaps Landing
42	-	-	40
45	-	43	43
47	45	45	45
50	48	48	48
56	53	54	54
57	54	55	55
63	60	60	60
73	70	70	70
85	81	82	82
94	90	-	-
106	101	-	-
113	108	-	-
125	120	-	-
135	129	-	-
140	134	-	-
146	140	-	-

NOTE

Indicated airspeed assumes zero instrument error



6 EMERGENCY PROCEDURES

This section describes the procedures to be adopted in the event of an emergency or abnormal situation occurring in the J170-C aircraft.

The procedures are arranged in the sequence considered to be the most desirable in the majority of cases. Steps should be performed in the order listed unless good reasons for deviation exist.

It should be remembered however, that all conceivable eventualities cannot be foreseen by the manufacturer. Particular circumstances such as multiple or unanticipated emergencies, adverse weather etc. may require modification to these procedures. A thorough knowledge of the aircraft and its systems is essential to analyse the situation correctly and determine the best course of action in any particular circumstance.

The following **basic rules** apply to all aircraft emergencies:

1. Maintain Aircraft Control.
2. Analyse the situation and take appropriate action.
3. Land as soon as practicable.

6.1 AIRSPEEDS FOR EMERGENCY OPERATIONS

Maximum Glide	65 KIAS*
Landing Without Engine Power (Flaps Full)	65 KIAS

* - A slightly higher speed may give better distance over the ground if gliding into wind; a slightly slower speed if gliding downwind.

6.2 EMERGENCY PROCEDURES CHECK LISTS

6.2.1 Engine Failures

Engine Failure During Take-off Run

1. Throttle..... CLOSED
2. Brakes..... APPLY
3. Ignition..... OFF
4. Wing Flaps..... UP
5. Master Switch..... OFF
6. Fuel Shutoff Valve..... OFF

Engine Failure Immediately After Take-off

1. Airspeed.....65 KIAS.
2. Ignition.....OFF (As time permits)
3. Fuel Shutoff Valve.....OFF (As time permits)
4. Wing Flaps.....FULL RECOMMENDED
5. Master Switch.....OFF
6. Braking.....HEAVY AFTER TOUCHDOWN



Engine Failure During Flight

1. Airspeed.....65 KIAS*
2. Carburettor Heat..... ON
3. Fuel Pump.....ON
4. Fuel Shutoff Valve.....CONFIRM ON
5. Fuel Quantity.....CHECK
6. Oil.....CHECK TEMP AND PRESSURE
7. Ignition.....CYCLE BOTH ON
8. Throttle.....CHECK LINKAGE OPERATION
9. Airstart.....ATTEMPT IF PROP STOPPED

* - A slightly higher speed may give better distance over the ground if gliding into wind; a slightly slower speed if gliding downwind.

6.2.2 Airstart & Limitations

In the event that the engine is stopped during flight, it may be restarted by application of fuel & ignition, provided that the propeller is still windmilling. The propeller may stop windmilling below 50 KIAS

The Jabiru engine is a high compression engine & therefore airstarts when the propeller has stopped rotating, without the use of the starter, are unlikely before reaching V_{NE}. Therefore, the following procedure addresses only airstarts by use of the starter motor.

IMPORTANT – NO NOT depress starter button while propeller is rotating.

1. Ignition.....OFF
2. Cabin.....CLEAR
3. Airspeed.....REDUCE UNTIL PROPELLER
STOPS TURNING.
4. Establish Glide.....65 KIAS
5. Fuel.....ON
6. Fuel Pump.....ON
7. Master.....ON
8. Ignition Switches.....ON
9. Starter Button.....Depress
10. Throttle.....Open
11. Repeat as necessary, ensuring propeller has stopped before each restart attempt.

- Notes:**
- (a) If engine does not restart commence forced landing procedure.
 - (b) If clear symptoms of a mechanical failure exist, or if the engine has seized due to the loss of oil pressure, do not attempt a restart.
 - (c) If engine operates with only L or R ignition selected, leave the ignition switch in this position whilst a suitable landing area is selected.
 - (d) The engine cools quickly with the propeller stopped. Choke may needed to achieve a start.



6.2.3 Forced Landings

Emergency Landing Without Engine Power

1. Airspeed..... 65 KIAS
2. Ignition..... OFF
3. Fuel Shutoff Valve..... OFF
4. Fuel Pump..... OFF
5. Throttle..... CLOSED
6. Wing Flaps..... FULL PRIOR TO TOUCH DOWN
7. Master Switch..... OFF AFTER LOWERING FLAPS
8. Braking..... HEAVY AFTER TOUCH DOWN

Precautionary Landing With Engine Power

1. Airspeed..... 70 KIAS
2. Fuel Pump..... ON
3. Wing Flaps..... TAKE-OFF
4. Selected field..... OVERFLY & INSPECT
5. Wing Flaps..... FULL ON FINAL APPROACH
6. Airspeed..... 65 KIAS
7. Braking..... HEAVY AFTER TOUCH DOWN
8. Ignition..... OFF
9. Fuel Shutoff Valve..... OFF
10. Master Switch..... OFF

Ditching

1. Airspeed..... 65 KIAS
2. Power (if available)..... ESTABLISH 50 ft/min @ 55 KIAS
3. Approach
 - High Winds, Heavy Seas..... INTO WIND
 - Light Winds, Heavy Swells..... PARALLEL TO SWELLS
4. Wing Flaps..... FULL PRIOR TO TOUCH DOWN
5. Doors..... OPEN
6. Face..... CUSHION AT TOUCH DOWN
7. Touch Down..... SLOWEST PRACTICAL SPEED
8. Evacuate..... IF REQUIRED BREAK WINDOWS
9. Life Jackets / Life Rafts..... INFLATE
10. EPIRB (If Carried)..... ACTIVATE

6.2.4 Fires

On Ground

1. Ignition..... OFF
2. Fuel Shutoff valve..... OFF
3. Fuel Pump..... OFF
4. Master Switch..... OFF
5. Abandon aircraft
6. Fire..... EXTINGUISH



Engine Fire In Flight

1. ThrottleCLOSE
2. Fuel ValveOFF
3. Fuel PumpOFF
4. Ignition.....OFF
5. Master Switch.....OFF AFTER FLAPS DEPLOYED
6. Cabin Heat VentCLOSE
7. Cabin Air VentOPEN BOTH
8. AirspeedINCREASE UP TO V_{NE} if required to
extinguish fire.
9. Forced Landing.....EXECUTE. Refer 6.2.3

Electrical Fire In Flight

1. Master Switch.....OFF
2. Ignitions.....ON
3. Electrical Switches.....OFF
4. Extinguisher.....ACTIVATE

If fire goes out:

5. SmokeVENTILATE CABIN (DOORS MAY
BE OPENED SLIGHTLY)
6. Precautionary Landing.....AS SOON AS PRACTICAL

If fire does not go out:

4. LandEXECUTE IMMEDIATELY

WARNING

With the Master Switch turned off the wing flaps will not deploy.

Cabin Fire

1. Master Switch.....OFF
2. Cabin Heat VentCLOSE
3. Cabin Air VentOPEN BOTH
4. Extinguisher (if fitted)ACTIVATE
5. LandAS SOON AS PRACTICAL
6. Smoke/Fume Evacuation.....VENTILATE CABIN. DOORS MAY
BE OPENED SLIGHTLY.

Once fire is extinguished:

1. PowerREDUCE
2. Airspeed.....APPROX 80 KIAS
3. Cockpit Door(s).....CLOSE
4. PowerADJUST to maintain approx 80 KIAS
5. LandAS SOON AS PRACTICAL

NOTE

Doors should only be opened for emergency fume evacuation



6.2.5 Carburettor Icing

If Carburettor icing is suspected:

1. Throttle..... FULL
2. CARB HEAT..... FULL ON

NOTE

Carburettor heat may be used at any power setting, but will result in a slight power loss. When icing is eliminated, return CARB HEAT to OFF. Carburettor heat should not be used for take-offs.

Maintain carburettor heat in ON position for a minimum of 1 minute to allow all ice to melt.

Carburettor heat may be used on the ground except during take-off.

CAUTION

Do not use partial carburettor heat as this may exacerbate ice accretion.

6.2.6 Fuel Low Pressure Warning Light Illuminates Continuously

If fuel low pressure warning light illuminates continuously:

1. Throttle..... Reduce to approx 2400RPM
2. Fuel gauges Check level. Fly aircraft with the wing with the most fuel above the other.
3. Precautionary Landing..... As soon as safe

NOTE

Due to the types of fuel pumps used, it is normal for the fuel pressure warning light to flicker at times during flight. The procedure outlined above should only be used where the light is ON consistently for 60 seconds or longer.

6.2.7 Landing With a Flat Main Tyre

1. Landing Area..... SUITABLE
2. Approach..... NORMAL
3. Wing Flaps FULL DOWN
4. Touchdown..... GOOD TYRE(S) FIRST, hold aircraft off flat tyre as long as possible with aileron and/or elevator control
5. Ignition OFF
6. Fuel Shutoff Valve OFF
7. Master Switch..... OFF

6.2.8 Inadvertent Icing Encounter

Flight into known icing conditions is prohibited. If icing is inadvertently encountered, change flight level or turn back to obtain an outside air temperature less conducive to icing.

6.2.9 Electrical Power Supply System Malfunctions

Alternator Failure

1. Non-essential electrical equipment OFF
2. Land AS SOON AS PRACTICAL



Alternator failure is indicated by the illumination of the “CHG FAIL” light on the instrument panel. While the Jabiru engine does not require external power to run, power consumption by the radio, transponder and other electrical systems will eventually discharge the battery.

6.2.10 Spins

Intentional spins are prohibited in this aircraft. Should an inadvertent spin occur, the following recovery procedure should be used:

- 1. Retard the throttle to idle**
- 2. Centralise ailerons**
- 3. Apply and hold full rudder opposite to the direction of rotation**
- 4. Move stick progressively forward far enough to break stall**
- 5. Hold these control inputs until rotation stops**
- 6. As rotation stops, centralise rudder and make a positive, smooth recovery from the resulting dive**

WARNING

If the spin is encountered with flaps extended, DO NOT retract flaps until rotation ceases. Premature flap retraction will delay recovery.



7 NORMAL PROCEDURES

7.1 GENERAL

This section describes the procedures to be adopted for normal operations of the J170-C aircraft.

The procedures are arranged in the sequence considered to be the most desirable and therefore steps should be performed in the order listed unless good reasons for a deviation exist. The lists below include checks for all optional equipment, so checks that do not apply to this aircraft may be skipped.

7.2 SPEEDS FOR NORMAL OPERATION

Unless otherwise noted, the following speeds are based on a maximum weight of 600 kg (1323lb) and may be used for any lesser weight.

Take-Off:

T.O.S.S. (Speed @ 50 ft)	65 KIAS
Normal Climb Out.....	70 KIAS (Take Off Flap)

Climb, Flaps Up:

Initial (scheduled climb)	70 KIAS
Enroute	70-80 KIAS

Landing Approach:

V_{REF} (Speed @ 50 ft)	65 KIAS
Balked Landing.....	65 KIAS Initially

Maximum Recommended in Turbulence:

All Weights	112 KIAS
-------------------	----------

7.3 BEST ANGLE OF CLIMB SPEED

V_x – Best Angle of Climb Speed	65 KIAS
---	---------

7.4 BEST RATE OF CLIMB SPEED

V_y – Best Rate of Climb Speed.....	68 KIAS
---------------------------------------	---------



7.5 PREFLIGHT INSPECTION

Before flight, a careful visual inspection is to be carried out to ensure that the aircraft and its systems are serviceable. The following Figure is to be used in conjunction with the preflight inspection checklist:

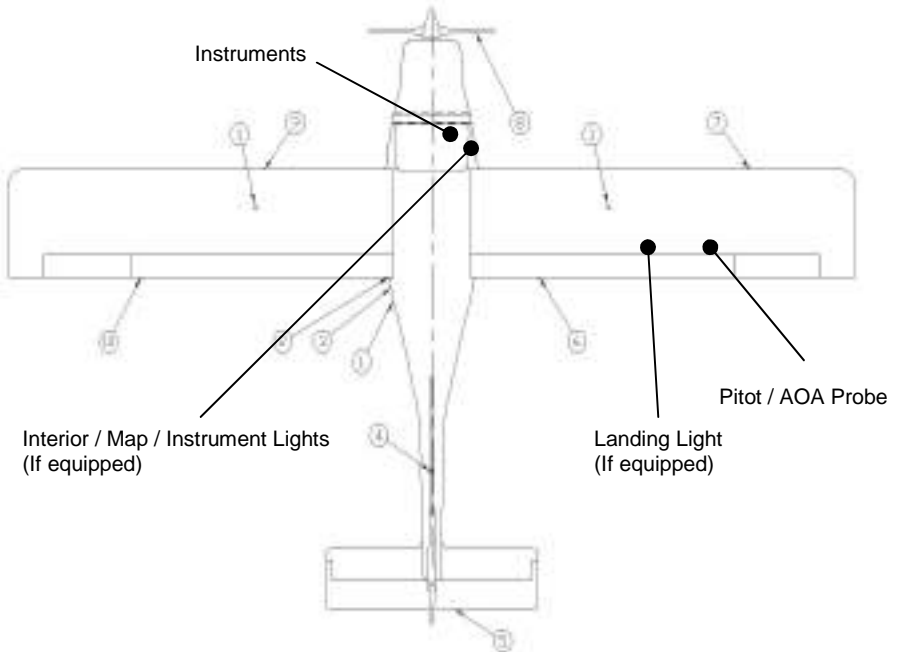

Figure 4-1. Pre-flight Inspection

1. Fuel

Quantity in both tanks..... Check
 Fuel caps..... Secure
 Water Check..... Both wing tanks and header tank

2. AOA / Pitot Head

All openings open / unobstructed..... Check
 Installation..... Secure

3. Cockpit

Ignition Switches..... OFF
 Control lock (if fitted)..... REMOVE
 Fuel CHECK CONTENTS
 Fuel valve..... ON
 Master switch ON
 Alternator Warning Light..... CONFIRM ON Before Start
 Master Switch..... OFF



Aileron and elevator cables & fasteners....CHECK
 Rudder and nose wheel steering linkage.CHECK
 Rudder centring springsCHECK
 Controls (all).....CHECK full travel, free movement.
 Harnesses & Seats.....CHECK CONDITION
 WindshieldCLEANLINESS
 Cockpit area.....GENERAL CONDITION
 Loose objects.....SECURE
 Cockpit Doors/LatchesCONDITION & OPERATION
 POHAVAILABLE

Instruments

Heading indicatorCheck
 Engine InstrumentsConfirm normal operation

Interior / Map / Instrument Lights

LightsCheck operation

4. Left Undercarriage

Mount boltsCHECK SECURE*
 Tyre.....CHECK CONDITION / INFLATION

* - Lock the hand brake on, then pull the aircraft forwards. Some flexing of the undercarriage legs is normal, but there should be no movement of the top of the leg relative to the fuselage.

5. Static Source

Static Source.....CHECK FOR BLOCKAGE

6. Empennage

Tail tie-down.....DISCONNECT
 Control surfacesCHECK Security & Full & Free Movement
 Rudder, Elevator & Trim CablesCHECK Security & Full & Free Movement

7. Right Wing – Trailing Edge

Aileron.....CHECK Security & Full & Free Movement
 Flap.....CHECK Security
 Control rods & cablesCHECK Security. Check rod ends for freedom of rotation & excess movement.

8. Right Wing

Wing Tie-Down.....DISCONNECT
 Wing Strut Mount Bolts.....CHECK Security**
 Wing Root Mount Bolts.....CHECK Security***
 Pitot Tube.....REMOVE COVER, CHECK for blockage.

** - Wing strut bolts must not be tightened. Nut should just bear on washer.

*** - Holding the wingtip, push the tip up & down, forwards & backwards. If a wing / strut attachment is degrading, slop will be felt.

9. Nose

Propeller & SpinnerCHECK for nicks & security
 CowlCHECK Security, rubbing on engine.
 Engine OilCHECK using oil filler door.



Nose Wheel..... CHECK condition & pressure.

10. “Pulling Through” The Engine

Before the first flight of the day the engine must be “pulled through” by hand. This is the process of turning the engine over by turning the propeller by hand. The compression of each cylinder in turn will be felt a resistance as the propeller is turned. The engine should be rotated for a count of at least 8 compressions.

Master Switch.....OFF
Ignitions.....OFF
Throttle.....Closed
Propeller.....TURN by hand & observe engine for odd noises or heavy movements. Check for regular compression.

CAUTION:

Prior to pulling through the propeller by hand, the engine must be cold, both ignition circuits & the Master Switch must be switched OFF, the brakes applied & throttle closed.

WARNING

**A hot engine may fire with the ignition/s switched OFF.
DO NOT pull through a hot engine.**

CAUTION

Several causes of irregular compression – such as poorly sealing valves – can lead to extensive engine damage if not addressed. The Jabiru 2200 Engine Instruction & Maintenance Manual provides additional details.

11. Left Wing

Wing Tie-Down DISCONNECT
Wing Strut Mount Bolts CHECK Security**
Wing Root Mount Bolts CHECK Security***

12. Left Wing – Trailing Edge

Aileron CHECK Security & Full & Free Movement
Flap CHECK Security
Control rods & cables CHECK Security. Check rod ends for freedom of rotation & excess movement.



7.6 NORMAL PROCEDURES CHECK LISTS

7.6.1 Before Starting Engine

Pre flight Inspection.....	COMPLETED
Passenger Briefing.....	COMPLETED
Harnesses.....	SECURE
Brakes.....	ON/PARK
Avionics (except EMS).....	OFF
EMS.....	ON
Circuit Breakers.....	IN
Fuel Level Warning Light (optional).....	CHECK using test switch

7.6.2 Starting Engine - Cold

Master Switch.....	ON
Fuel Shutoff Valve.....	ON
Carburettor Heat.....	OFF
Choke.....	ON*
Throttle.....	CLOSED
Fuel Pump.....	ON
Ignition switches.....	ON
Starter.....	ENGAGE when engine fires RELEASE**
Oil Pressure.....	CHECK (pressure to be indicated within 10 secs)
Choke.....	Closed
Throttle.....	900 – 1000 RPM
Alternator Warning Light.....	CHECK OFF
Avionics.....	ON

* - If the engine is hot, proceed as for cold engine, but do not use choke.

** - If the engine is turning at less than 300 RPM it will not start.

7.6.3 Before Take-Off

Park Brake.....	ON
-----------------	----

Ground Check & Run Up

Warm Up.....	1000-1200 RPM avoid prolonged idle at low RPM
Ignition Check.....	2000 RPM Both-L-Both-R-Both. Max drop 100RPM
Carburettor heat.....	2000 RPM – ON – slight drop in RPM
Carburettor heat.....	2000 RPM – OFF – RPM restored
Power Check.....	2850 RPM +/- 150 RPM
Idle Check.....	700 – 900 RPM
Trim.....	SET – Neutral
Avionics.....	Check (pitch, heading, etc)

Pre Take-Off

Master Switch.....	ON
Ignition switches.....	BOTH ON
Fuel Shutoff Valve.....	ON
Fuel Quantity.....	CHECK sufficient for task
Fuel Pump.....	ON
Flaps.....	TAKE OFF (first stage)
Instruments.....	SET AND CHECK ALL



Switches..... SELECTED as required
 Circuit Breakers..... CHECK
 Controls..... FULL & FREE TRAVEL, CORRECT SENSE
 Hatches..... CLOSED & LOCKED
 Harnesses SECURE all seat belts correctly fastened and adjusted
 Oil temperature..... ABOVE 50°C

7.6.4 Take-Off

Carburettor heat OFF
 Throttle..... FULL OPEN
 Elevator Control..... NEUTRAL
 Directional Control NOSEWHEEL STEERING & RUDDER
 Rotate..... 30 – 40 KIAS raise nosewheel clear of ground
 Take Off Safety Speed 65 KIAS
 Accelerate to Climb Speed 70 KIAS
 Flaps UP
 Fuel Pump..... OFF at top of climb.
 Power..... SET as required.

7.6.5 Initial Climb

Throttle..... FULL OPEN
 Airspeed..... 70 KIAS

7.6.6 Cruise

75% Power..... 2800 RPM

7.6.7 Descent

Power..... As required
 Carburettor heat As required

7.6.8 Before Landing (and flight below 1000ft AGL)

Brakes..... OFF
 Harnesses SECURE
 Fuel Pump..... ON

7.6.9 Landing

Airspeed @ 50ft..... 65 KIAS
 Wing Flaps FULL
 Directional Control RUDDER & NOSEWHEEL STEERING
 Power AS REQUIRED
 Touchdown Main wheels first
 Braking..... AS REQUIRED

NOTE

If the aircraft is contaminated by build up of insects or other debris, increase approach speed @ 50ft to 68 KIAS



7.6.10 Baulked Landing

Power.....FULL THROTTLE
 Carburettor heatCOLD
 Wing Flaps.....RETRACT **SLOWLY**
 Airspeed.....ESTABLISH NORMAL CLIMB SPEED

7.6.11 After Landing/Securing

Wing Flaps.....UP
 Fuel Pump.....OFF
 Parking Brake.....ON/AS REQUIRED
 Avionics.....OFF
 IgnitionOFF
 Master Switch.....OFF
 Controls.....SECURE

7.6.12 Short Field Take-Off

Elevator Trim.....NEUTRAL
 Fuel Tap.....ON
 Fuel Pump.....ON
 Carburettor HeatOFF (COLD)
 Wing FlapsTAKE-OFF SETTING
 Brakes.....HOLD FULL ON BY HAND
 Throttle.....FULL. Wait for engine RPM to peak
 Brakes.....RELEASE
 RotateAS SOON AS POSSIBLE
 Lift-off.....BEST ANGLE OF CLIMB SPEED until clear
 of obstacles.

7.6.13 Short Field Landing

Approach.....FLAT. Aim for wheels to touch as near to the
 target point as possible. Approach under
 power.
 Power.....APPROX 1500 RPM
 Airspeed.....55 KIAS
 Touch-downAT TARGET POINT. Wheel brakes are
 The best way to slow the aircraft. Touching
 down positively and slightly fast then braking
 heavily will give shortest landing distances.
 Power.....IDLE
 Brakes.....HEAVY. DO NOT LOCK WHEELS.

NOTE

Short field landings are potentially high risk manoeuvres. Reducing approach speeds and approaching under power reduce the aircraft's safety margins, especially in a wind gust or if the engine fails. Where possible, they should only be attempted in good conditions. If students are being taught short field landings the weather conditions must be appropriate and a displaced threshold used.

NOTE

After heavy braking such as that required for a short field landing brake temperatures will rise dramatically and afterwards brake effectiveness may be significantly reduced.



7.6.14 Engine Management – Ground Running

The 2200B engine fitted to the J170-C is cooled by air flowing over the engine and oil cooler. During ground running care must be taken to ensure that there is adequate airflow and that safe engine temperatures are maintained. The guidelines presented below will assist in controlling temperatures.

- Minimise ground running times – especially in hot weather⁴.
- Carry out as many checks as possible before starting the engine.
- Always carry out engine run-up tests with the aircraft pointing into wind.
- In hot weather, after performing run-up checks, leave the aircraft pointing into wind and idling at 1200rpm for 30 seconds to aid cooling.
- If the aircraft is required to wait – such as for runway clearance – temperatures must be monitored, and if they approach ground running limits (listed in Section 3 of this flight manual & displayed as yellow markings on engine gauges) the aircraft must be turned into wind or shut down to prevent any further temperature increase.
- Wind must be coming from within approximately 45° of the aircraft heading to be effective in aiding engine cooling.
- If there is no wind or low wind the engine must be shut down if ground-running temperature limits are reached.

⁴ 30°C and above



8 AIRCRAFT GROUND HANDLING AND SERVICING

8.1 FUEL

- Avgas 100LL
- Avgas 100/130
- MOGAS with minimum Octane Rating of 95 RON¹ may be used.
- Do not use fuel additives such as Octane Boosters.

NOTE

As there are significant variations possible even between automotive fuels with the same values of RON, Jabiru Aircraft strongly recommend using AVGAS. Automotive fuels should only be used where AVGAS is not available, and if used, must have the highest anti-detonation rating practically available.

CAUTION

Fuel additives containing alcohol (i.e. Ethanol etc) will damage the sealant used in the fuel tanks. DO NOT use fuel with any level of added alcohol.

8.2 OIL

8.2.1 Engine Oil Specification:

Jabiru Aircraft approves lubricating oils of any brand name conforming to specifications MIL-L-6082 for straight mineral oil and MIL-L-22851 for ashless dispersant oil.

Straight mineral oil must be used during the first 50 hours of operation for new and overhauled engines, or until the oil consumption has stabilised. After the first 50 hours it is recommended that ashless dispersant oil be used.

8.2.2 Engine Oil Viscosity Grade:

The following chart is intended to assist in choosing the correct grade of oil and must be considered as a guide only. Multiviscosity grades can also be used as indicated

Average Ambient Temperature	Mineral Grades	Ashless Dispersant Grades
Above 35° C (95°F)	SAE 60	SAE 60
15° C to 35° C (59° to 95°F)	SAE 50	SAE 50
-17° C to 25° C (1° to 77°F)	SAE 40	SAE 40

Equivalence of SAE and commonly used Commercial Grade designations:					
SAE:	20	30	40	50	60
Commercial:	55	35	80	100	120



8.3 BRAKES

The brakes of the J170-C use automotive brake fluid. Refer to the J160/J170 Technical manual for details of appropriate brake fluid specifications.

WARNING:

The JABIRU uses automotive brake fluid (DOT 3 or DOT 4). DO NOT use Aircraft hydraulic fluid (mineral based) or damage to the brake system will result.



9 CLIMATIC RESTRICTIONS

Maximum Ambient Operating Temperature 38°C
Flight into known icing conditions Prohibited



10 SUPPLEMENTS

This section consists of a series of supplements, each being self contained and providing details and procedures associated with the fitment of optional and special purpose equipment.

Each supplement contains a brief description, and where applicable, operating limitations, emergency and normal procedures, and the effect on aircraft performance. The data contained in a supplement adds to, supersedes, or replaces similar data in the basic POH when operating in accordance with the provisions of that supplement.

The Log of Supplements shows the CASA Approved Jabiru Aircraft Supplements available for the J170-C at the date of publication of this POH. The Log of Supplements page can be utilised as a Table of Contents for this section. A check mark (✓) in the Install column indicates that the corresponding supplement is incorporated in the POH.

It is the owner's responsibility to ensure that new Jabiru Aircraft Supplements received after receipt of the POH are recorded on the Log of Supplements page.

In the event that the aircraft is modified at a non Jabiru Aircraft facility through an STC or other approval method, it is the owner's responsibility to ensure that the proper supplement, if applicable, is installed in the handbook and the supplement is properly recorded on the Log of Supplements page as amended from time to time.



10.1 LOG OF SUPPLEMENTS – JABIRU AIRCRAFT SUPPLEMENTS

Applicable to aircraft serial number J170-C _____

Install	Doc. No.	Title	Date



This Page Intentionally Left Blank